

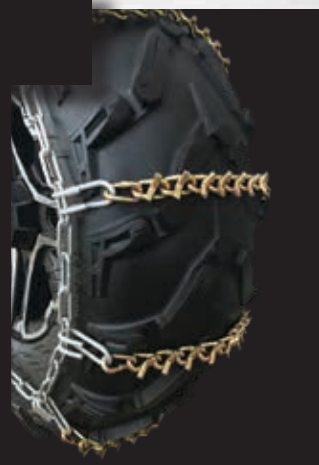

2018-2019 EDITION | VERSION 1A





**EAGLE PLOW**

YOU GOT THE POWER... WE GOT THE PLOW...<sup>®</sup>

A **HITCHDOC** PRODUCT



**EAGLE WINCH**<sup>®</sup>

A **HITCHDOC** PRODUCT

**TALON**  
TIRE CHAINS

**DIRTMASTER**



# Table of Contents

4-5 Latest Innovations

6-7 Eagle Snow Blades

8-12 Eagle Plow Systems

13-19 Plow & Winch Mount Guides

20-23 Plow System Accessories & Parts

24-25 Eagle Winches

26-30 Racks, Carriers & Accessories

31 Towing & Trailer Needs

32 HitchDoc Motorcycle Hitches

33-35 Motorcycle Hitch Mounts

36-37 Snowmobile Tools

38-39 DirtMaster & Other Products

# Latest Innovations

## 80" Standard Straight Blade

Move massive amounts of snow with the widest Eagle Plow on the market!

- Cover the wheel track of the largest machines with this rugged, 80-inch blade
- Manufactured from 11-gauge, US Prime steel to handle colossal amounts of snow
- Steel gussets are strategically placed to increase blade support & strength



## 72" Slanted Country Blade

Use the largest Eagle Country blade for the best snow rolling experience!

- This burly, slanted blade is manufactured with US Prime, 11-gauge steel
- 72 inches of pure strength for plowing the longest drives
- Staggered steel gussets boost blade endurance for season after season use



# Latest Innovations

## 72" & 80" Redesigned V-Blades

New 72" & 80" bow tie blade design has raised height & a blade curvature sure to move snow with ease!

- 72" & 80" of sleek steel to effortlessly cut through snow in various positions
- These blades offer the ability to start manual then upgrade to a hydraulic system (Part #2964)
- Larger widths & higher blade heights tapering up from the center of the blade increase plowing capacity
- Now powder-coated in Jet Black or Titanium Yellow for the ultimate high-gloss finish



Order the 2960 Series Manual or Hydraulic V-Plows with part numbers 2806 (UTV push tube for tires) or 2807 (UTV push tube for tracks) with a specific machine mount to complete your ultimate plowing package.

## Completely Hydraulic V-Blades

Cut snow removal project times significantly with the completely hydraulic Eagle V-Plows!

- Smoothly control your snow plow with the Smart Button Remote Control from your cab
- V, scoop, angle or straighten your blade without leaving your machine with widths in 72" & 80"
- Redesigned blade curve, height & positioning make for one noteworthy snow mover

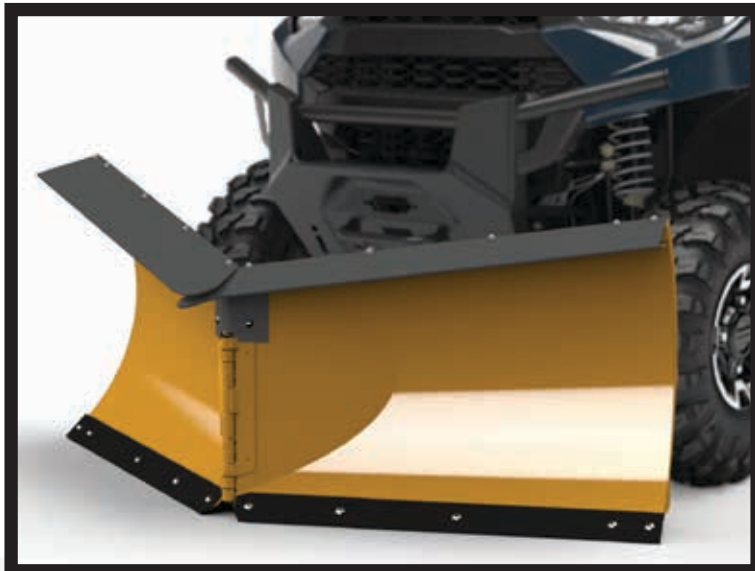
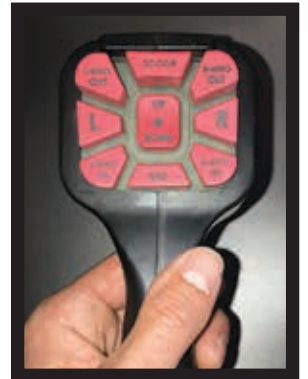

# Eagle Snow Plows

Eagle Plows date back to the 3-wheeler era, they have withstood the test of time & we continue to innovate the industry's first plows today. Blades continue to be engineered & manufactured in Minnesota, USA, by the snow experts from US Prime steel for maximum strength & durability. Starting with 11-gauge steel, then precision laser cut, rolled, & welded for just the right performance & durability. All plow systems are coated with a high-gloss, powder-coat finish in black, red or yellow depending on blade style.

Eagle Plow Systems have the ability to work on most makes/models of ATVs & UTVs/SxSs. The latest designs of push tubes & plows interchange with the classic designs, making upgrading to a new machine economical & effortless. Each blade easily engages & disengages from the plow system in between uses or for storage. (Photos of this can be found on page 11 & plowing accessories & replacement parts can be found on page 20).

## Standard Straight Blades

- **NOW OFFERING:** 80" blade for the ultimate plow coverage
- Rugged design allows for easy snow rolling
- Tough, heavy duty wear bar is reversible & replaceable
- Manually adjusts to 5 blade positions or is compatible with the hydraulic Eagle Motion Pac (Page 21)
- 66", 72" & 80" blades come with rubber flap & plow markers
- Use the adjustable skid shoes with spacers to protect the blade & surface

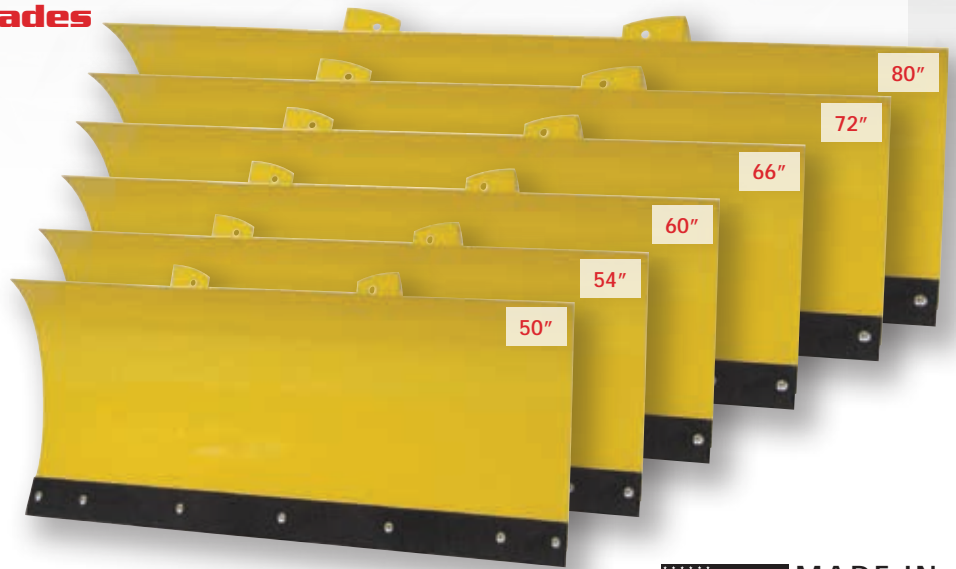

## Slanted Country Blades

- **NOW OFFERING:** 72" blade for non-stop snow rolling
- Slanted design is best used for high capacity plowing
- Tough, heavy duty wear bar is reversible & replaceable
- Manually adjusts to 5 blade positions or is compatible with the hydraulic Eagle Motion Pac (Page 21)
- All Country Blades come with a rubber flap & plow markers
- Adjustable skid shoes with spacers allow for smooth surface contact

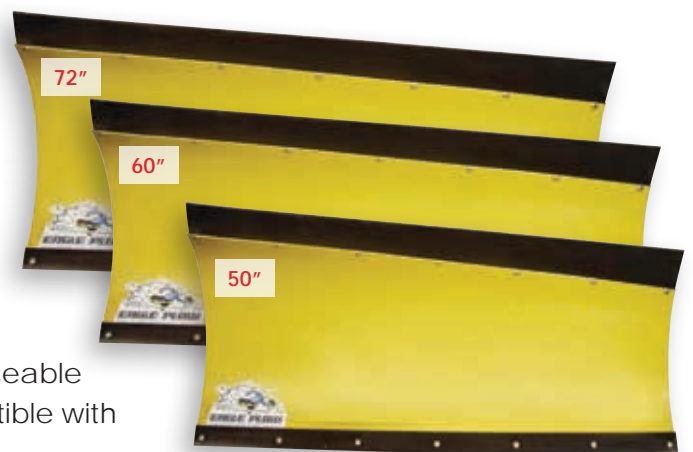

# Eagle Snow Plows

## Eagle V Force V-Blade

- **NOW OFFERING:** 80" sizes & hydraulic V-blades for UTVs
- Adjustable blade panels allow for variable movements
- Cut snow straight, angled to each side, scooped forward or V position back
- All V-Blades come with rubber flaps
- Comes with adjustable skid shoes & spacers
- Cutting edge is removable & replaceable

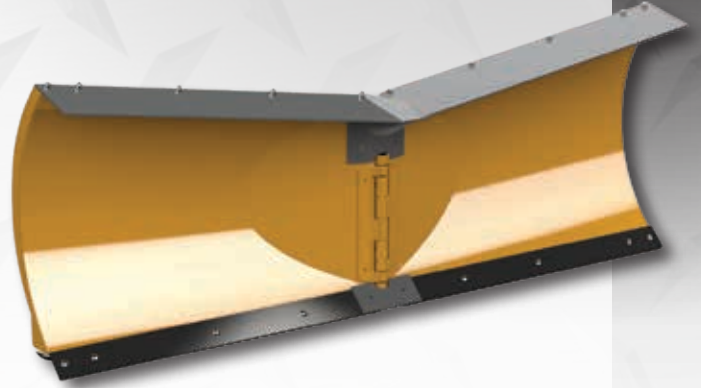

	PART #	WIDTH	HEIGHT	ANGLED CUT WIDTH		MACHINE SIZE
<b>STANDARD STRAIGHT BLADES</b>	2910-Black	50"	15 ¾"	43 ¾"		350cc+
	2911-Yellow					
	2912-Black	54"	15 ¾"	47 ¼"		350cc+
	2913-Yellow					
	2920-Black	60"	15 ¾"	52 ½"		600cc+
	2921-Yellow					
	2927-Black	66"	15 ¾"	57 ¾"		650cc+
	2928-Yellow					
	2922-Black	72"	15 ¾"	63"		700cc+
	2924-Yellow					
2931-Black	80"	15 ¾"	70"		850cc+	
2932-Yellow						
<b>SLANTED COUNTRY BLADES</b>	2915-Black	50"	17"-21 ¾"	43 ¾"		400cc+
	2916-Yellow					
	2925-Black	60"	17"-21 ¾"	52 ½"		600cc+
	2926-Yellow					
	2917-Black	72"	17"-21 ¾"	63"		700cc+
	2918-Yellow					
<b>V-BLADES</b>	<b>MANUAL</b>		<b>SCOOPED</b>		<b>V</b>	
	2919-Red	60"	17"	53.4"	53"	600cc+
	2929-Red	66"	17"	58.9"	58"	650cc+
	2937-Red	72"	17"	64.4"	63.1"	700cc+
	2961 - Black 2967 - Yellow	72"	21"-26"	63 ¾"	66"	700cc+
	2963 - Black 2969 - Yellow	80"	21"-27 ½"	71"	73 ¼"	850cc+
	<b>HYDRAULIC</b>		<b>SCOOPED</b>		<b>V</b>	
	2960 - Black 2966 - Yellow	72"	21"-26"	57 ½"	66"	700cc+
	2962 - Black 2968 - Yellow	80"	21"-27 ½"	63 ¾"	73 ¼"	850cc+

# Original Eagle Plow System

The Original Eagle Plow System has years of 'in-the-field' engineering & continuous innovation with modern machine mounts. Once each mount, push tube & swivel is manufactured, it is then powder-coated with a Jet-Black finish that will withstand the harsh, winter elements. The Original Eagle Plow system mounts to the belly of your ATV & offers an easy install. A winch or hand lift kit are needed to lift the blade. The system is composed of a model specific mount, universal push tube mount, push tube specific for tires or tracks with swivel & has the ability to pair with any Eagle Plow Blade. (Plow replacement parts & accessories can be found on page 20).



## Model Specific ATV Mid-Mount Plate:

- Stays on year-round & acts as a steel, skid plate
- Won't affect oil changing or ground clearance
- Made from 11-gauge steel & attaches with provided hardware
- See pages 13-19 for your specific ATV mid-mount

## Universal Push Tube Mount Plate:

- Offers pins for instant engaging & disengaging of plow system with the Quick-Latch Brackets
- Removable after the season & replaceable (Part #0200)
- Made from 10-gauge steel & attaches with provided grade 5 carriage bolts

## Original Eagle Push Tube with Swivel:

- Manufactured from 1-1/2" high strength square tubing (Part #2906)
- Attaches in seconds with the Quick-Latch brackets & locks in place
- V-shaped design & cross bars for increased stability
- Swivel adjust to 5 positions offering 30° of rotation to each side
- Swivel rotates on a heavy duty 5/8" bolt mounted to 1/4" solid steel

## Eagle Blade:

- Blade mounts to the push tube swivel with 1/2" bolts
- Adjustable, bolt-on blade stops offer 4 blade pitch positions
- Comes with trip springs & eye bolts for added blade plowing protection





# Gen II Plow System

The Gen. II Plow System is designed for those who want quick connect/disconnect of the plow system. This system mounts to the front of your ATV frame with a model specific mount which connects machine to push tube & blade. Altogether, this system has three major components; the Gen. II front mount, Gen. II push tubes with swivel & any Eagle Plow Blade. The blade in this system can only be lifted using a winch.

The Gen. II Plow System is manufactured in Minnesota, USA, & each piece of the system is powder-coated in Jet Black for a long-lasting finish. Plow system replacement parts & accessories can be found on page 20.

## Model Specific ATV Front Mount:

- Quick-Latch pins offer instant engaging & disengaging
- See pages 13-19 for your specific ATV front mount
- Some mounts recommended to be removed in off-season to maintain ground clearance

## Gen. II Eagle Push Tubes with Swivel:

- 1-1/2" high strength square tubing
- Attaches in seconds with the Quick-Latch brackets
- Swivel adjusts to 5 positions offering 30° of rotation to each side
- Swivel rotates on a heavy duty 5/8" bolt mounted to 1/4" solid steel
- See pages 11-12 for specific push tube information

## Eagle Blade:

- Blade attaches to the Swivel System with 1/2" bolts
- Adjustable, bolt-on blade stops offer 4 blade pitch positions
- Includes industrial trip springs & eye bolts for added blade protection
- See pages 6-7 for specific blade information



# Eagle UTV Plow System

Put your UTV to work this winter! When you want to move snow with a front mount install, the Eagle UTV Plow System is for you. Front mount connection points are easily accessible to quickly engage & disengage the plow assembly. This system is composed of a model specific mount, UTV push tube with swivel & any Eagle Plow Blade.

Blade lifting can only be done with a winch & blade turning can be done manually or with the Eagle Motion Pac found on page 21. Plow system replacement parts & accessories can be found on page 20.

## Model Specific UTV Front Mount:

- Manufactured from 1/4" steel & attaches with grade 5 hardware to the frame
- Clevis pins are included for attaching push tubes
- See pages 13-19 for your specific UTV Front mount
- Some mounts may recommend off-season removal to maintain ground clearance

## UTV Push Tubes with Swivel:

- 1 1/2" high strength formed tubing
- Standard Push Tube for attaching to UTVs with tires (Part#2805)
- Extended Push Tube available for attaching to UTVs with tracks (Part#2808)
- Eagle Motion Pac & Push Tubes allow for hydraulically positioning the blade (see page 21)
- Multiple cross members & V-shaped design for added hardness to the entire system
- Manually adjust to 5 positions offering 30° of rotation to each side
- Rotates on a heavy duty 5/8" bolt mounted to 1/4" solid steel

## Eagle Blade:

- Blade attaches to the Swivel System with 1/2" bolts
- Adjustable, bolt-on blade stops offer 4 blade pitch positions
- Heavy duty trip springs & eye bolts protect your blade when plowing



# Mount to Push Tube Attachments

## Original Eagle ATV Mid-Mount

(Part #2906)



## Eagle Gen. II ATV Front Mount

(Part #3906/3908)



## Eagle UTV Front Mount

(Part #2805/2808)



# Order Guides

## Original Eagle Plow System

With years of 'in-the-field' engineering, the Original Eagle Mid-Mount Plow System is ready to plow through snow, no matter how much stands in your way. The mount & push tubes mount to the belly of your ATV. Use any Eagle Plow Blade with this system (except the 2960 Series V-Plow).

ORDER GUIDE

- Review the Model Specific Mount Guide (Pages 13-19) ..... Part # \_\_\_\_\_  
\*\*Note: Universal Push Tube Mount is included with Model Specific Mounts
- Order the Original Eagle Push Tube ..... Part # 2906
- Select your Eagle Plow Blade (Pages 6-7) ..... Part # \_\_\_\_\_
- Optional Lifting Accessory: Hand Lift Kit (Page 22) ..... Part # \_\_\_\_\_
- Optional Lifting Accessory: Winch (Pages 24-25) ..... Part # \_\_\_\_\_
- Optional Lifting Accessory: Winch Mount (Pages 13-19) ..... Part # \_\_\_\_\_

## Eagle Gen. II Plow System

Easily mount to the front of your ATV with the Eagle Gen. II Front Mount Plow System. Each mount is made specifically for your machine with push tubes to match either tires or tracks. This system works with any Eagle Plow Blade (except the 2960 Series V-Plow).

ORDER GUIDE

- Review the Model Specific Mount Guide (Pages 13-19) ..... Part # \_\_\_\_\_
- Order the proper Gen. II Push Tube ..... Part # \_\_\_\_\_  
Standard Push Tube for Tires: Part # 3906  
Extended Push Tube for Tracks: Part # 3908
- Select your Eagle Plow Blade (Pages 6-7) ..... Part # \_\_\_\_\_
- Optional Lifting Accessory: Winch (Pages 24-25) ..... Part # \_\_\_\_\_
- Optional Lifting Accessory: Winch Mount (Pages 13-19) ..... Part # \_\_\_\_\_

## Eagle UTV Plow System

Smash through snow with your UTV & the Eagle UTV Front Mount Plow System. Each mount is made specifically for your make/model & mounts to the front of your machine. Mount & push tubes are made to work with any Eagle Plow Blade (except the 2960 Series V-Plow).

ORDER GUIDE

- Review the Model Specific Mount Guide (Pages 13-19) ..... Part # \_\_\_\_\_
- Order the proper Eagle UTV Push Tube ..... Part # \_\_\_\_\_  
Standard Push Tube for Tires: Part # 2805  
Extended Push Tube for Tracks: Part # 2808
- Select your Eagle Plow Blade (Pages 6-7) ..... Part # \_\_\_\_\_
- Optional Lifting Accessory: Winch (Pages 24-25) ..... Part # \_\_\_\_\_
- Optional Lifting Accessory: Winch Mount (Pages 13-19) ..... Part # \_\_\_\_\_

# Mount Guides

MODEL	YEAR	MID-MOUNT	FRONT MOUNT	WINCH MOUNT
<b>ARCTIC CAT</b>				
<b>ATV</b>				
250 2x4, 4x4	99-05	2010	-	1005
300 2x4, 4x4	98-01	2010	-	1005
300 2x4, 4x4	02-04	2010	-	1010
300 2x4, 4x4	05	2010	-	1005
350 4x4 (CR)	12	2012	-	-
366 4x4	08-09	2012	-	1012
400 2x4, 4x4	96-01	2010	-	1005
400 2x4, 4x4 (ACT) (i)	02-05	2010	-	1010
400 2x4, 4x4	06-08	-	3950	FIM
400 Automatic 2x4, 4x4 (LE)	03-08	2010	3950	1010
400 Automatic 4x4 ACT	03-04	2010	3950	-
400 Automatic 4x4 TBX	04	2010	3950	-
400 Automatic 4x4 TBX	05-06	2010	3950	FIM
400 Automatic 4x4 TRV	06-12	2010	-	FIM
400 Automatic 4x4 TRV	13	2010	3950	FIM
400 Automatic 4x4	14	2010	3950	FIM
450 4X4	10-12	2010	3950	1015
454 2x4 / 4x4	98	2010	-	1005
500 4x4	96-01	2010	-	1005
500 4x4	02-04	2010	-	-
500 4x4	05-14	2010	3950	-
500 AUTO	00-02	2020	-	1005
500 TBX 4x4	02-06	2010	3950	FIM
500 TRV 4x4	03-05	2010	-	-
500 TRV 4x4	06-16	2010	3950	FIM
500i	96-02	2010	-	1005
550 4x4	09-14	2010	3950	1015
550 Alterra 4x4	16	2014	3951	FIM
550 Alterra TRV 4x4	17	2014	3951	FIM
550 TRV 4x4	09-16	2010	3950	FIM
550 XR 4x4	15	2014	3951	FIM
650 4x4	04-05	2010	-	-
650 4x4	06-11	2010	3950	-
650 TRV 4x4	07-11	2010	-	FIM
700 4x4 (AUTO) (AUTO EFI) (M4) (H1 SE)	06-16	2010	-	1015
700 Alterra 4x4 (XT)	16-17	2014	3951	FIM

MODEL	YEAR	MID-MOUNT	FRONT MOUNT	WINCH MOUNT
700 Alterra TRV 4x4	17	2014	3951	FIM
700 Diesel	06-16	2010	-	1015
700 Mud Pro	06-08	2010	-	1015
700 Mud Pro	09-17	2010	3950	-
700 TBX 4x4	06	2010	-	FIM
700 TBX 4x4	07-17	2010	3950	FIM
700 TRV 4x4	06-16	2010	3950	FIM
700 VLX	17	2010	3950	FIM
700 XR 4x4	15	2014	3951	FIM
1000 4x4	08-17	2015	3950	FIM
1000 TRV 4x4	09-17	2015	3950	FIM
1000 Thundercat H2 (LE) 4X4	08-10	-	3950	FIM
<b>UTV; SxS</b>				
500 Prowler	17	N/A	2865	-
500 Prowler HDX	14-15	N/A	2860	-
500 Prowler HDX	16-17	N/A	2864	FIM
550 Prowler (XT)	09-14	N/A	2860	1860
550 Prowler (XT)	15	N/A	2864	-
650 Prowler H1 XT 4X4	06-09	N/A	2860	1860
700 Prowler (XTX)	08-14	N/A	2860	1860
700 Prowler	15-17	N/A	2864	FIM
700 Prowler HDX	16-17	N/A	2864	FIM
700 Prowler HDX Crew	17	N/A	2864	FIM
1000 Prowler XTZ 4X4	10-14	N/A	2860	1860
1000 Prowler	15-16	N/A	2864	FIM
Wildcat Sport	14-17	N/A	2866	FIM
Wildcat Trail	14-17	N/A	2866	FIM
<b>ARGO</b>				
500 Xplorer XR (LE)	18	2180	3980	1180
500 Xplorer XRT (LE)	18	2180	3980	1180
<b>BOBCAT</b>				
<b>UTV; SxS</b>				
3200 Series	11-14	N/A	2859	1859
3400 4X4	12-14	N/A	2859	1859
3400 4X4	15-18	N/A	2885	-
<b>CAN-AM</b>				
<b>ATV</b>				
330 Outlander 2x4, 4x4 (XT)	03-05	2110	-	1110

# Mount Guides

MODEL	YEAR	MID-MOUNT	FRONT MOUNT	WINCH MOUNT
330 Outlander Max 4x4 (XT)	03-05	2110	-	1110
400 Outlander 4X4 (XT)	03-05	2110	-	1110
400 Outlander 4X4 (XT)	06-12	2111	3911	1112
400 Outlander 4X4 (XT)	13-14	2115	3911	1112
400 Outlander 4X4 (XT)	15	2115	-	1112
400 Outlander Max 4x4 (XT)	06-12	-	-	1112
400 Outlander Max 4x4 (XT)	13	2115	3919	1112
400 Outlander Max 4x4 (XT)	14-15	2115	-	1112
450L Outlander (XT)	15-16	-	3928	FIM
450L Outlander MAX (XT)	15-16	-	3928	FIM
450 Outlander (XT)	17-18	-	3928	FIM
450 Outlander MAX (XT)	17-18	-	3928	FIM
500 Outlander (XT)	07-12	2111	3911	1112
500 Outlander (XT)	13-15	2115	3919	1112
500 Outlander 4x4 MAX (XT)	13-15	2115	3919	-
500 Quest	02-04	2105	-	1105
500 Traxter	99-05	2105	-	1105
570 Outlander (XT)	16-17	-	3928	1112
570 Outlander (XT)	18	-	3928	-
570 Outlander MAX (XT)	16-17	-	3928	1112
570 Outlander MAX (XT)	18	-	3928	-
570L Outlander (XT)	16	-	3928	-
570L Outlander MAX (XT)	16	-	3928	-
570 Renegade 4x4 XC, X XC	16-18	2115	-	-
650 Outlander 6x6	13-17	2115	-	-
650 Outlander (XT)	06-12	2111	3911	1112
650 Outlander (XT)	13-18	2115	3919	-
650 Outlander MAX (XT)	06-12	2111	-	1112
650 Outlander MAX (XT)	13-18	2115	3919	1112
650 Quest	02-04	2105	-	1105
800 Outlander (XT)	06-11	2111	3911	-
800 Outlander (XT)	12-15	2115	3919	1112

MODEL	YEAR	MID-MOUNT	FRONT MOUNT	WINCH MOUNT
800 Outlander MAX (XT)	06-12	2112	3911	1112
800 Outlander MAX (XT)	13-15	2115	3919	1112
800R Outlander (XT)	11	2111	3911	1112
800R Outlander (XT)	12	2115	3912	1112
800R Outlander (XT)	13-15	2115	3919	-
800R Outlander MAX (XT)	11-12	2111	-	1112
800R Outlander MAX (XT)	13-15	2115	3919	-
800 Renegade	07-11	2111	-	1115
850 Outlander (XT)	16-18	2115	3919	-
850 Outlander (XT)	19	2115	-	-
850 Outlander MAX (XT)	16-18	2115	3919	-
850 Renegade (G2)	16-17	2115	-	-
1000 Outlander 4x4 (XT)	13-18	2115	3919	1112
1000 Outlander MAX 4x4 (XT)	13-18	2115	3919	1112
1000 Renegade (G2)	12-18	2115	-	-
<b>UTV; SxS</b>				
500 Defender HD5	17-19	N/A	2809	FIM
800 Commander	11-17	N/A	2811	1811
800 Defender HD8	16-19	N/A	2809	FIM
1000 Commander	11-17	N/A	2811	1811
1000 Defender HD10	16-19	N/A	2809	FIM
1000 Maverick	13-17	N/A	2810	1810
<b>CF MOTO</b>				
<b>ATV</b>				
500 Cforce	13-14	2070	-	-
600 Cforce	13-14	2070	-	-
800 Cforce	13-16	2070	-	FIW
X-5 (LWB) (SWB)	12-14	2070	-	-
X-6 (LWB) (SWB)	12-14	2070	-	-
X-8 (LWB) (SWB)	12-14	2070	-	-
<b>UTV; SxS</b>				
500 Uforce	16-17	N/A	2872	FIW
600 Rancher (EFI)	12-13	N/A	2870	-
800 Uforce	13	N/A	2872	-
800 Uforce	14-18	N/A	2872	FIW
800 Zforce EX	14-17	N/A	2869	FIW

# Mount Guides

MODEL	YEAR	MID-MOUNT	FRONT MOUNT	WINCH MOUNT
<b>CUB CADET</b>				
<b>UTV; SxS</b>				
550 Challenger (MX)	17-18	N/A	FIM*	FIW
700 Challenger	15	N/A	2823	-
750 Challenger (MX)	17-18	N/A	FIM*	FIW
Tracker	07-09	N/A	2822	1822
Tracker	10-14	N/A	2822	-
Volunteer	07-14	N/A	2822	1822
*Factory installed plow mount is compatible with Eagle Plow system push tubes and blades. No additional mount needed.				
<b>HONDA</b>				
<b>ATV</b>				
TRX 300	88-92	2215	-	-
TRX 300	93-00	2215	-	1240
TRX350 Rancher	00-03	2210	3922	1220
TRX350 Rancher	04-06	2210	3923	1220
TRX400 Foreman	95-04	2210	-	1215
TRX400 Rancher	00-03	2210	-	1220
TRX400 Rancher	04-07	2210	3923	1220
TRX420 Rancher 2x4, 4x4 (All Models)	07-13	2230	3926	1225
TRX420 Rancher 4X4 "IRS ONLY"	14	2230	3926	1225
TRX420 Rancher 4X4 "SOLID AXLE ONLY"	14	2237	3927	1234
TRX420 Rancher 2x4, 4x4 (All Models)	15-17	2237	3927	1234
TRX420 Rancher 2x4, 4x4 (All Models)	18	-	3927	1234
TRX450 Foreman	95-97	2210	-	1215
TRX450 Foreman	98-04	2210	3924	1215
TRX450 Rubicon	98-04	-	3924	1215
TRX500 Foreman	05-06	2225	3925	1230
TRX500 Foreman	07-11	2225	3925	1235
TRX500 Foreman S/ES/FPE	12-13	2236	-	1236
TRX500 Foreman (All Models)	14-17	2237	3927	1234
TRX500 Foreman (All Models)	18	-	3927	1234
TRX500 Rubicon (All Models)	01-04	2205	-	1210
TRX500 Rubicon (All Models)	05-06	2205	3925	1230

MODEL	YEAR	MID-MOUNT	FRONT MOUNT	WINCH MOUNT
TRX500 Rubicon (All Models)	07-14	2205	3925	1235
TRX500 Rubicon (All Models)	15-18	2206	3927	1234
TRX650 Rincon	03-05	2205	3905	1230
TRX680 Rincon	06-17	2205	3905	1230
<b>UTV; SxS</b>				
500 Pioneer	15-17	N/A	2839	1839
700 Big Red MUV	09-13	N/A	2815	1815
700 Pioneer	14-18	N/A	2838	1838
700 Pioneer 4	14-18	N/A	2838	1838
1000 Pioneer	16-18	N/A	2845	1844
1000 Pioneer 5	16-18	N/A	2845	1844
<b>JOHN DEERE</b>				
<b>ATV</b>				
500 Buck	04-06	2105	-	-
500 Trail Buck	04-05	2105	-	-
650 Buck	04-06	2105	-	-
650 Trail Buck	04-05	2105	-	-
<b>UTV; SxS</b>				
Gator 6X4	93-14	N/A	2831	1831
Gator HPX	04-12	N/A	2830	1831
Gator HPX	13-15	N/A	2830	-
550 Gator XUV	12-17	N/A	2833	1834
550 Gator XUV S4	12-17	N/A	2833	1834
560 Gator XUV	16-17	N/A	2833	1834
560 Gator XUV S4	16-17	N/A	2833	1834
590 Gator XUV	16-17	N/A	2833	1834
590 Gator XUV	18	N/A	2833	FIW
590 Gator XUV S4	16-17	N/A	2833	1834
620i Gator XUV	07-10	N/A	2830	-
625i Gator XUV	11-15	N/A	2832	1832
825i Gator XUV	11-17	N/A	2832	1832
825i Gator XUV S4	13-17	N/A	2832	1832
835 Gator XUV	18	N/A	2829	-
850i Gator RSX	12-15	N/A	2834	1834
860 Gator RSX (i) (E) (M)	16-18	N/A	2834	-
850D Gator XUV	07-10	N/A	2830	-
855D Gator XUV	11-15	N/A	2832	1832
855D Gator XUV S4	11-15	N/A	2832	1832

# Mount Guides

MODEL	YEAR	MID-MOUNT	FRONT MOUNT	WINCH MOUNT
<b>KAWASAKI</b>				
<b>ATV</b>				
250 Bayou	05	2335	-	-
300 Bayou	89-03	2320	-	1330
300 Prairie	99-02	2325	-	-
360 Prairie	02-12	2315	-	1320
400 Prairie	97-02	2325	-	1310
650 Brute Force	05-11	2315	-	1315
650 Brute Force	12-13	2315	-	-
650i Brute Force	06-09	2330	-	1340
650i Brute Force	10	2330	-	-
650i Brute Force	11	2330	3931	1341
650i Brute Force	12	2330	-	1341
650i Brute Force	13	2330	-	-
650 Prairie	02-04	2315	-	1305
700 Prairie 4x4	04-06	2315	-	1335
750i Brute Force	05-07	2330	-	-
750i Brute Force	08-14	2330	3931	1341
750i Brute Force	15-18	2330	3931	1316
<b>UTV; SxS</b>				
600 Mule	05-16	N/A	2840	1840
610 Mule	05-16	N/A	2840	1840
750 Teryx (RUV)	08-13	N/A	2842	1842
750 Teryx 4	12-13	N/A	2843	1843
800 Teryx (LE)	14-17	N/A	2843	1843
800 Teryx (LE)	18	N/A	2843	-
800 Teryx 4 (LE)	14-17	N/A	2843	1843
800 Teryx 4 (LE)	18	N/A	2843	-
820 Mule Pro FX	16-18	N/A	2863	1862
820 Mule Pro FXR	18	N/A	2863	1862
820 Mule Pro FXT	15-17	N/A	2863	1862
1000 Diesel Mule Pro (DXT) (DX)	16-17	N/A	2863	1862
3000 Mule	01-08	N/A	2820	FIM
3010 Mule	01-08	N/A	2820	FIM
4000 Mule	09-11	N/A	2821	-
4000 Mule (TRANS)	12-18	N/A	2821	1821
4010 Mule	09-11	N/A	2821	-
4010 Mule (SE) (TRANS)	12-18	N/A	2821	1821
<b>KIOTI</b>				
<b>UTV; SxS</b>				
2200 Mechron	14	N/A	2880	1880
2200 Mechron	15	N/A	2880	-

MODEL	YEAR	MID-MOUNT	FRONT MOUNT	WINCH MOUNT
<b>KUBOTA</b>				
<b>UTV; SxS</b>				
400ci RTV 4X4	12-16	N/A	2814	1814
500 RTV 4X4 (2" Receiver)	09-16	N/A	2814	1814
900 RTV 4X4 (1-1/4" Receiver)	04-09	N/A	2814	1812
900 RTV 4X4 (2" Receiver)	10-16	N/A	2813	1813
900 RTV 4X4 (Rect. Tube Bumper)	11-12	N/A	2814	-
1100 RTV 4X4 (1-1/4" Receiver)	08-10	N/A	2814	1812
1100 RTV 4X4 (Rect. Tube Bumper)	11-12	N/A	2814	1816
1140 RTV 4X4 Crew (2" Receiver)	10-16	N/A	2813	1813
900 RTV-X	14-18	N/A	2814	FIM
1100C RTV-X	14-17	N/A	2814	FIM
1120D RTV-X	14-17	N/A	2814	FIM
<b>KYMCO</b>				
<b>UTV; SxS</b>				
450i UXV (LE) (LE Prime) (LE Hunter)	15-18	N/A	2865	FIM
500i UXV 4X4	12-18	N/A	2855	FIM
700i UXV (LE) (LE EPS) (LE Prime) (LE Hunter)	14-18	N/A	2855	FIM
<b>ODES</b>				
<b>UTV; SxS</b>				
800 Dominator (2 & 4 Door)	13-16	N/A	2867	
800 Dominator X2	15-16	N/A	2868	-
800 Dominator X4	15-16	N/A	2868	-
1000 Dominator	15-16	N/A	2867	
1000 Dominator X2	15-16	N/A	2868	-
1000 Dominator X4	15-16	N/A	2868	-
<b>POLARIS</b>				
<b>ATV</b>				
300 4X4	94-95	2420	-	-
300 Hawkeye	06-07	2425	-	1425
300 Sportsman	08-10	2425	-	1425
330 ATP	04-05	2410	-	1410
330 Magnum 4x4	03-06	2410	-	1410



# Mount Guides

MODEL	YEAR	MID-MOUNT	FRONT MOUNT	WINCH MOUNT
400 Hawkeye	08-09	2425	-	1425
400 Hawkeye	10	2425	-	-
400 Sportsman	01-04	2405	-	1410
400 Sportsman	05	2405	3938	1415
400 Sportsman	06-07	2405	-	1415
400 Sportsman	08-09	2425	-	1425
400 Sportsman	10	2425	-	-
400 Sportsman	11-14	2405	3937	1413
425 Magnum	94-98	2420	-	-
450 Sportsman	05	2405	-	-
450 Sportsman	06	2405	3938	-
450 Sportsman (H.O.)	16-18	2411	3942-REV A	1413
500 ATP	04-05	2410	-	1410
500 Sportsman	96-97	2410	-	-
500 Sportsman	98-03	2405	-	1410
500 Sportsman	04	2405	-	1407
500 Sportsman	05-10	2405	3938	1415
500 Sportsman	11-13	2405	3937	1413
500 Sportsman	14	-	3937	1413
500 Sportsman 6X6	92	2410	-	-
500 Sportsman Touring	08-09	2410	-	1415
500 Sportsman Touring	12	2405	-	1413
500 Sportsman X2	06	2425	-	1415
500 Sportsman X2	07-08	2412	3938	1415
500 Sportsman X2	09	2410	3938	1415
550 Sportsman	09	2414	-	-
550 Sportsman	10-14	2414	3940	1414
550 Sportsman Touring	10-14	2414	-	-
550 Sportsman X2	10-14	2414	3940	1414
550 Sportsman XP	09-11	-	3940	1414
570 Sportsman	14	2411	3937	1413
570 Sportsman	15-18	2411	3942-REV A	1413
570 Sportsman (SP)	15-18	2411	3942	1413
570 Sportsman Touring	14	2411	3937	1413
570 Sportsman Touring	15-18	2411	3942-REV A	1413
570 Sportsman X2	15-18	2411	3942-REV A	1413
570 Sportsman 6x6	18	2411	-	1413
600 Sportsman	02-04	2410	-	1407
600 Sportsman	05-07	2410	-	1415
700 Sportsman	02-04	2410	-	1407

MODEL	YEAR	MID-MOUNT	FRONT MOUNT	WINCH MOUNT
700 Sportsman	05-08	2410	-	1415
700 Sportsman X2	08	2412	-	1415
800 Sportsman	05-10	2410	-	1415
800 Sportsman	11	2405	-	1413
800 Sportsman	12-14	2405	3937	1413
800 Sportsman Big Boss 6X6	12	2405	-	1413
800 Sportsman Touring	08-09	2410	-	1415
800 Sportsman X2	07	2412	-	1415
800 Sportsman X2	09	2410	3938	1415
850 Scrambler	13-17	2414	-	1414
850 Scrambler XP	13-14	-	3941	1414
850 Sportsman	09-14	2414	3940	1414
850 Sportsman	15-18	2414	-	1414
850 Sportsman Touring	10-14	2414	3940	1414
850 Sportsman Touring (SP)	15-18	2414	-	1414
850 Sportsman X2	10	2414	-	1414
850 Sportsman X2	11	2414	3938	1414
1000 Scrambler XP	14-17	2414	-	1414
1000 Sportsman XP	15-18	2414	-	1414
1000 Sportsman Touring XP	15-18	2414	-	1414
Diesel 4X4	99-01	2405	-	-
Sportsman	93-95	2420	-	1400
Sportsman 6X6	91-99	2420	-	1400
Sportsman 6X6	00-06	2420	-	-
Sportsman ETX	15	-	3942-REV A	1413
Sportsman Twin (All CC'S)	05-09	-	3939	-
Xplorer 400 (Chain Drive)	96-98	2409	-	1400
Xplorer 400 (Shaft Drive)	98-02	2410	-	1410
Xplorer 400L (Shaft Drive)	96-97	2410	-	1410
Xplorer 500 (Shaft Drive)	97	2410	-	1410
UTV; SxS				
400 Ranger 4X4 Midsize	10-14	N/A	2847	1847
500 Ranger 4X4 Midsize (Crew)	11-13	N/A	2847	1847
500 Ranger 4X4 Midsize	17-18	N/A	2857	1847

# Mount Guides

MODEL	YEAR	MID-MOUNT	FRONT MOUNT	WINCH MOUNT
570 Ranger 4X4 Midsize (2-Seater)	14-18	N/A	2857	1857
570 Ranger 4X4 Midsize Crew (4-Seater)	14-18	N/A	2857	1857
570 Ranger Full Size (3-Seater)	15	N/A	2856	1854
570 Ranger Full Size (3-Seater) 4x4 (Round Tube/800 Body Style)	16-18	N/A	2857	1857
570-6 Ranger Full Size Crew (6-Seater) 4x4 (Round Tube/800 Body Style)	16-18	N/A	2857	1857
570 RZR	12-17	N/A	2852	1852
700 Ranger	09	N/A	2846	-
700 Ranger Full Size Crew	08-09	N/A	2850	1850
700 Ranger Full Size Crew	10-11	N/A	2851	-
800 Ranger 4X4 Midsize (2-Seater)	13-14	N/A	2857	1847
800 Ranger Full Size 4x4 [3-Seater] (XP) (HD)	10-14	N/A	2851	1851
800 Ranger Full Size 4x4 Crew [6-Seater]	10-14	N/A	2851	-
800 RZR	08-14	N/A	2852	1852
800 RZR-4	10-14	N/A	2852	1852
900 RZR	11-14	N/A	2853	1853
900 RZR	15-18	N/A	2858	1858
900 RZR-4	11-14	N/A	2853	1853
900 RZR-4	15-17	N/A	2858	1858
900 RZR S	15-18	N/A	2858	1858
900 RZR S-4	18	N/A	2858	1858
900 RZR Trail	16-17	N/A	2858	1858
900 RZR XC	15-17	N/A	2858	1858
900 XP Ranger Full Size	13-18	N/A	2856	1854
900 XP Ranger Crew	14-18	N/A	2856	1854
900 XP Ranger Limited Edition	13-14	N/A	2854	-
1000 General	16-18	N/A	2858	1858
1000 RZR XP	14-18	N/A	2858	1858
1000 RZR XP-4	14-18	N/A	2858	1858

MODEL	YEAR	MID-MOUNT	FRONT MOUNT	WINCH MOUNT
1000 RZR S	16-18	N/A	2858	1858
1000 XP Ranger Full Size 4x4	17	N/A	2856	1854
1000 XP Ranger Full Size 4x4	18-19	N/A	2885	1885
1000 XP Ranger Full Size 4x4 Crew	17-18	N/A	2856	1854
Ranger (All CC'S)	05-08	N/A	2850	1850
Ranger XP (All CC'S)	05-08	N/A	2850	1850
Ranger 4X4	01-04	N/A	2849	1849
Ranger 6X6	98-01	N/A	2848	1848
Ranger EV 4X4 Midsize	11-17	N/A	2847	1847
Ranger EV 4X4 Midsize	19	N/A	2857	1857
Ranger Diesel	15-17	N/A	2856	1854
Ranger ETX Midsize 4x4	15-16	N/A	2847	1847
Turbo RZR XP	16-18	N/A	2858	1858
Turbo RZR XP-4	16-18	N/A	2858	1858
<b>SUZUKI</b>				
<b>ATV</b>				
250 Quad Runner	99-02	2525	-	-
280 King Quad	91-98	2525	-	-
300 King Quad	93-98	2525	-	-
300 King Quad	99-00	2525	-	1520
300 King Quad	01-02	2525	-	1515
300 King Quad	03	2525	-	-
400 Eiger 2x4, 4x4	02-07	2520	-	-
400 King Quad	08-17	2520	-	1510
450 King Quad	06	-	3930	1530
450 King Quad	07-10	2530	3930	1530
450 King Quad	11-12	-	3930	1530
500 King Quad	09-17	2530	3930	1530
500 LFT Quad Runner	98-02	2520	-	-
500 Vinson	02-06	2520	3910	1505
500 Vinson	07	2010	3910	1505
700 King Quad 4x4	05-07	2530	3930	1530
700 King Quad 4x4	08-16	-	3930	1530
700 Twin Peaks	04-06	2315	-	1335
750 King Quad 4x4	08-17	2530	3930	1530
750 King Quad 4x4	18	2530	-	-

# Mount Guides

MODEL	YEAR	MID-MOUNT	FRONT MOUNT	WINCH MOUNT
<b>UTV; SxS</b>				
QUV	05	N/A	2820	-
<b>TEXTRON (BAD BOY OFF ROAD)</b>				
<b>ATV</b>				
500 Alterra	18	2012	-	-
700 Alterra MudPro	18	2010	3950	-
700 Alterra VLX	18	2010	3950	FIM
<b>UTV; SxS</b>				
Bad Boy Ambush 4X4	13-14	N/A	2873	-
Bad Boy Classic 4X4	06-10	N/A	2875	-
Bad Boy Instinct 4X4	13-14	N/A	2873	-
Bad Boy Recoil 4X4	13-14	N/A	2873	-
Bad Boy XT 4X4	10-11	N/A	2874	-
Bad Boy 900 Stampede	16	N/A	2877	FIM
Textron Off Road 900 Stampede	17	N/A	2877	FIM
Textron Off Road Stampede XTR 900	17	N/A	2877	FIM
Wildcat Trail (XT) (LTD)	18	N/A	2866	FIM
Stampede	18	N/A	2877	FIM
Stampede X	18	N/A	2877	FIM
Stampede 4	18	N/A	2877	FIM
Stampede 4X	18	N/A	2877	FIM
Havoc X	18	N/A	2877	FIM
<b>YAMAHA</b>				
<b>ATV</b>				
250 Bruin	05-06	2620	-	-
350 Bruin 2x4, 4x4	04-06	2615	-	1615
350 Grizzly 2x4, 4x4	07-09	2615	3916	1615
350 Grizzly 2x4, 4x4	10-12	2615	3916	-
350 Grizzly 2x4, 4x4	13-14	2615	-	1615
350 Wolverine	95-05	2620	-	1655
400 Big Bear 2x4 4x4	97-06	2620	-	1650
400 Big Bear 2x4 4x4	07-11	2620	-	1640
400i Big Bear	07-09	2640	-	1640
400 Grizzly	05-07	-	3916	1615
400 Kodiak	94-98	2630	-	-
400 Kodiak	99	2620	-	-
400 Kodiak	00-02	2615	-	1620

MODEL	YEAR	MID-MOUNT	FRONT MOUNT	WINCH MOUNT
400 Kodiak	03-07	2615	3916	1615
450 Grizzly	03-06	-	3916	1615
450 Grizzly	07-12	2615	3916	1615
450 Grizzly	13-14	2615	3916	-
450 Kodiak	03-12	2615	3916	1615
450 Kodiak	13-14	2615	-	-
450 Kodiak (SE)	18	2616	3921	FIM
450 Wolverine	06-08	2615	-	1660
450 Wolverine	09	2615	-	-
550 Grizzly 4x4	07-08	-	3915	1625
550 Grizzly 4x4	09-12	2615	3915	1625
550 Grizzly 4x4	13-14	2610	3915	1625
600 Grizzly 4x4	98-01	2625	-	1610
660 Grizzly 4x4	02-08	2615	3914	1605
700 Grizzly 4x4	07-12	2615	3915	1625
700 Grizzly 4x4	13-14	2610	3915	1625
700 Grizzly 4x4	15	2610	-	1625
700 Grizzly 4x4	16	2610	3918	1618
Grizzly LE/SE 4x4	17-18	2610	3920	1618
700 Kodiak 4x4	16	2610	3918	1618
700 Kodiak 4x4 (SE)	17-18	2610	3920	1618
<b>UTV; SxS</b>				
450 Rhino	06-11	N/A	2835	1635
660 Rhino	04-08	N/A	2835	1635
700 Rhino	06-13	N/A	2835	1635
Viking	14-18	N/A	2836	1836
Viking	19	N/A	2836	-
Viking VI	15-18	N/A	2836	1836
Wolverine	16-17	N/A	2837	1637
Wolverine	18	N/A	2837-REV A	-
Wolverine R-Spec (SE)	16-17	N/A	2837	1637



# Plowing Replacement Parts

American Manufacturing brought years of experience, innovation, & manufacturing to the ATV/UTV/SxS accessories market, while HitchDoc will continue to bring unsurpassed loyalty, service, & dedication to our customers. Eagle Plows offer a variety of plowing accessories & replacement parts to keep your snow where it belongs. Warranty information on the products included in this catalog can be found on the back cover.

PART #	PRODUCT
<b>WEAR BARS:</b> 1/4" thick American steel, laser cut to proper specifications, hardware included with Eagle Wear Bars only	
2970	50" Eagle Plow Wear Bar
2972	54" Eagle Plow Wear Bar
2975	60" Eagle Plow Wear Bar
2978	66" Eagle Plow Wear Bar
2980	72" Eagle Plow Wear Bar
2981	80" Eagle Plow Wear Bar
2975V	60" Eagle V-Blade Wear Bars (2)
2978V	66" Eagle V-Blade Wear Bars (2)
2980V	72" Eagle V-Blade Wear Bars (2)
2981V	80" Eagle V-Blade Wear Bars (2)
2970CC48	48" Cycle Country Wear Bar
2972CC54	54" Cycle Country Wear Bar
2975CC60	60" Cycle Country Wear Bar
2978CC66	66" Cycle Country Wear Bar
2980CC72	72" Cycle Country Wear Bar
2970M50	50" Moose Wear Bar
2975M60	60" Moose Wear Bar
2972W54	54" Warn Wear Bar
2975W60	60" Warn Wear Bar
2980W72	72" Warn Wear Bar
<b>BLADE ACCESSORIES</b>	
2950	Plow Marker Set (2 markers)
2941	Left Plow Shield
2942	Right Plow Shield
2943	Country Plow Shield

PART #	PRODUCT
<b>RUBBER FLAPS:</b> 3/16" thick rubber flap, 6" tall, attaches to top of Eagle Blades to prevent snow blowing up while plowing, hardware included	
2945	50" Eagle Plow Rubber Flap
2948	54" Eagle Plow Rubber Flap
2946	60" Eagle Plow Rubber Flap
2949	66" Eagle Plow Rubber Flap
2947	72" Eagle Plow Rubber Flap
2951	80" Eagle Plow Rubber Flap
2946V	60" V-Blade Rubber Flaps (2)
2949V	66" V-Blade Rubber Flaps (2)
2947V	72" V-Blade Rubber Flaps (2)
2951V	80" V-Blade Rubber Flaps (2)
2929-18	Replacement V-Blade Front Flap
<b>2960 Series V-Plow Specific Replacement Parts</b>	
2964	V-Blade Hydraulic Upgrade Kit
2965	V-Blade Hydraulic to Manual Kit
2960-90	V-Blade Spring Kit
2960-06	Lifting Lug
2964-02	Hydraulic Power Kit
2964-03	Hydraulic Hose Kit
2964-04	Hydraulic Cylinder (1)
<b>MISCELLANEOUS HARDWARE</b>	
0200	Original Plow System Universal Push Tube Mount
0250	Blade Swivel
0251	Blade Position Pin Assembly
0251-3	Lifting Lug
0252	Blade Stop Kit (1 pair) with Hardware
0253	Quick Latches & Hardware (2)
2986	Skid Replacement Hardware Only (1)
2987	Skid Hardware & Bracket
2989	Skid & Hardware
2990	Trip Springs & Hardware
2937-27	V-Blade Trip Springs & Hardware
HDW1879	Push Tube Pin Kit



**#0250**  
BLADE SWIVEL



**#0251**  
BLADE POSITION PIN ASSEMBLY



**#0253**  
QUICK LATCHES & HARDWARE (2)



**#2987**  
SKID HARDWARE & BRACKET



**#2989**  
SKID & HARDWARE

# Eagle Motion Pac

Hydraulically control your plow position from the seat of your UTV with the Eagle Motion Pac by KYB. Powered by a single, 3/4" chrome hydraulic shaft, Eagle Plow Blades can move snow exactly where you want it!

These kits are manufactured & assembled for front mount UTV plow systems. Different lengths are available for machines with tires & tracks. Systems are sold as complete units & include the required push tube, wiring harness, hydraulic cylinder & swivel system. Some assembly required.

PART #	DESCRIPTION
2939U	Eagle Motion Pac for UTVs with tires
2959U	Eagle Motion Pac for UTVs with tracks
2939-15	Replacement Motion Pac
2939U-WH	Replacement wire harness



# Eagle Hand Lift Kit

## Eagle Hand Lift Kit

Working with the Original Eagle Plow System, a Hand Lift Kit can be purchased to manually raise & lower your mid-mount ATV plow system. The kit is manufactured with a 3/4" handle tube & 3/8" lifting link that connects to the plow system's push tube to raise & lower the blade. Lift height is variable from machine to machine but has an easy-to-set float position with the bumper strap. The Eagle Hand Lift Kit is easy to install on any ATV & is fully adjustable; the height of the handle can change for added leverage when lifting the blade.

PART #	DESCRIPTION
2900	Hand Lift for Eagle Original ATV Plow System
2900-22	Linkage Rod with Ends
2909	Bracket Kit
HDW2320	Bushing Kit



2900-22



# Talon Tire Chains

Get more bite with the ladder-style, hardened V-bar Talon Tire Chains. Deep links won't fall between tire lugs when running on ice, slush, or hard packed snow. Five size options available to fit the majority of factory or specialty ATV/UTV tires. Chains have four links between cross sections to increase your grip in harsh winter conditions.

Talon Tire Chains are sold in rear pairs & come with a plastic case for year-round storage. They are easy to install; start by lying flat, rolling on & cinching up. Chains are zinc plated for corrosion resistance.



PART #	CLASS	CHAIN SIZE	TIRE SIZE(S)
3301	A	52" L x 14" W	22x8x11, 22x10x9, 22x10x10, 22x11x8, 22x11x9, 22x11x10, 25x11x8
3302	B	52" L x 14.5" W	24x9x11, 24x10x11, 24x11x10, 25x8x12
3303	C	56" L x 16" W	24x13x9, 25x10x12, 25x11x10, 25x12x9, 25x12x10, 25x13x9, 25x13.5x12
3304	C+	61" L x 16" W	Oversized 26" tires
3305	D	66" L x 16" W	Oversized 27" tires
Part # HDW1888 – Replacement Tire Chains Case			

# Eagle Winch

Get in there, get dirty, get stuck & get the Eagle Winch to get you out of any tough situation. Each winch is water-resistant with a sealed construction to keep the harshest elements out. Eagle Winches are a durable utility tool for use by off-road enthusiasts around the globe on the trails, in the fields or back in the woods.

Winches are manufactured with a full metal composition & a hardened triple planetary gear system that transmits torque to a permanent magnet motor. This system also offers superior controls with the handlebar rocker switch or optional wireless remote kit but can also free spool out.

Every Eagle Winch is designed for easy mounting with either a 2- or 4-hole mounting design. ATV/UTV mounts made from 7-gauge, American steel are sold separately & can be found in the Mount Guides on pages 13-19.

## #1920

Eagle 2,500 lb.  
Steel Cable Winch



## #1925

Eagle 3,500 lb.  
Steel Cable Winch

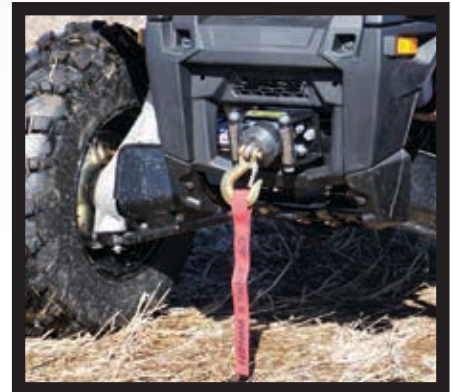

## #1920R

Eagle 2,500 lb.  
Synthetic Rope Winch



## #1926

Eagle 2,000 lb.  
Steel Cable Winch  
(2-Hole Mount Design)



## #1923

Eagle 2,000 lb.  
Nylon Strap Winch



## #1930

Eagle 4,500 lb.  
Steel Cable Winch

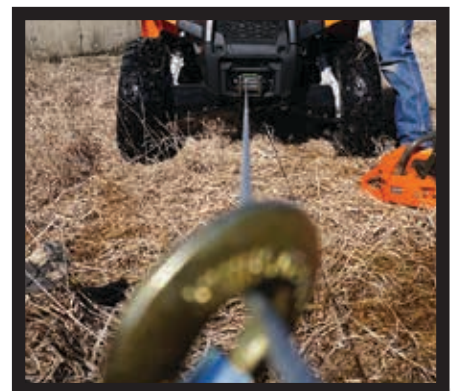



# Eagle Winch

PART #	TOW LIMIT	WINCH DIMENSIONS	CABLE/ ROPE DI-MENSIONS	INCLUDED ITEMS
1923	2,000 lbs.	10" L x 4.25" H x 4" W	3' x 1 1/2"	Winch, <u>nylon strap</u> , hook, battery & motor cables, solenoid, handlebar rocker switch & mount, mounting hardware
1926	2,000 lbs.	12.5" L x 4.25" H x 4" W	50' x 5/32"	Winch, <u>steel cable</u> , rubber cable stop, heavy-duty fairlead, battery & motor cables, solenoid, handlebar rocker switch & mount, safety pull strap, mounting hardware, snatch block, hook. *Note: 2-hole mount design
1920	2,500 lbs.	12.75" L x 4.25" H x 4.06 W	46' x 7/32"	Winch, <u>steel cable</u> , rubber cable stop, heavy-duty fairlead, battery & motor cables, solenoid, handlebar rocker switch & mount, safety pull strap, mounting hardware, snatch block, hook
1920R	2,500 lbs.	12.75" L x 4.25" H x 4.06 W	50' x 3/16"	Winch, <u>synthetic rope</u> , rubber cable stop, aluminum hawse, battery & motor cables, solenoid, handlebar rocker switch & mount, safety pull strap, mounting hardware, snatch block, hook
1925	3,500 lbs.	13.25" L x 4.19" H x 4" W	43' x 7/32"	Winch, <u>steel cable</u> , rubber cable stop, heavy-duty fairlead, battery & motor cables, solenoid, handlebar rocker switch & mount, safety pull strap, mounting hardware, snatch block, hook
1925R	3,500 lbs.	13.25" L x 4.19" H x 4" W	50' x 3/16"	Winch, <u>synthetic rope</u> , rubber cable stop, aluminum hawse, battery & motor cables, solenoid, handlebar rocker switch & mount, safety pull strap, mounting hardware, snatch block, hook
1930	4,500 lbs.	14.5" L x 4.87" H x 4.5" W	42' x 7/32"	Winch, <u>steel cable</u> , rubber cable stop, heavy-duty fairlead, battery & motor cables, solenoid, handlebar rocker switch & mount, safety pull strap, mounting hardware, snatch block, hook

## Wireless Remote Kit - #1915

Stand back & watch your Eagle Winch work with the Eagle Winch Wireless Remote Kit. Kit includes a hand-held remote transmitter with a long-life battery & a receiver that attaches to the winch system in minutes with a 4-prong female connector. Remote can reach up to 50' range with an extendable antenna & indicator lights to confirm winch connection.

Eagle Winch Remote Kit can be used on ATVs & UTVs with front or rear mounted winches using a 12V or 24V electrical system but is not recommend for use with winches that are used for cranes, construction or industrial purposes.



## Eagle Winch Replacement Parts

Eagle Winches are made to work hard & withstand the harsh elements. Although, warranty information can be found on the back cover.

### REPLACEMENT PARTS

1900	Heavy Duty Fairlead
1910	Snatch Block & Hook
1911	Switch & Replacement Solenoid Kit
1912	42' cable rated for 2,500 lbs. 3/16" diameter cable with G43 hook
1913	Rocker Switch
1914	Replacement Solenoid
1916	Replacement Cable Hook
1917	2,500 lb. 3/16" Rope Only
1918	Rubber Cable Stop
1919	Aluminum Hawse Only with Hardware
1921	2,500 lb. 3/16" Rope & Aluminum Hawse
1915	Wireless Remote Kit
1922	Remote & Rocker Switch Control Splitter

# Racks & Carriers

## Front Racks

### Now for both composite & tubular!

Add rugged front hauling space without impairing driver's vision with these heavy-duty front racks.  $\frac{3}{4}$ " square, 16-gauge American steel tubes supporting a 16-gauge, laser cut mesh basket strong enough to take a beating! Racks are powder-coated with a black rubberized finish. Hardware is universal for easy mounting for both tubular & composite racks.

PART#	DESCRIPTION	DIMENSIONS
4880	Universal Front Rack	37.25" W x 12.75" L x 6" D
4881	Slotted Front Rack	37.25" W x 12.75" L x 6" D



## Rear Racks

### Now for both composite & tubular!

Increase ATV hauling capacity with any of the rear racks. Manufactured with  $\frac{3}{4}$ " square, 16-gauge wall steel tube for ultimate strength. Laser cut & fabricated steel basket is powder-coated with a black rubberized finish for years of reliable durability. Universal mounting hardware & instructions included.

PART#	DESCRIPTION	DIMENSIONS
4879	Universal Rear Rack	40.5" W x 22.75" L x 6" D
4883	Rear Drop Rack	40.75" W x 26.5" L x 12.75" D



## Gas Can Carriers

Transport fuel safely & efficiently with these steel framed, gas can carriers. With a simple design, it will bolt-on to most ATVs with a metal front or rear rack. No drilling required & all hardware required is included along with instructions. Inside dimensions will fit a variety of 1 or 2 1/2 gallon fuel cans.

- Bolt-on, no cutting mounting
- 5/8" round 16-gauge wall steel tube
- Formed 11-gauge steel bracket & base
- Powder-coated in Jet Black
- Gas can not included

#4235



#4234



PART #	DESCRIPTION (INSIDE DIMENSIONS)
4234	1 Gal. Gas Can Carrier (7" W x 9" L x 5 3/4" H)
4235	2 1/2 Gal. Gas Can Carrier (8 3/4" W x 12 5/8" L x 5" H)

# Racks & Carriers

## Chainsaw Holder

Simply loosen the wing nut of this chainsaw holder, slide the chainsaw bar in, tighten & ride away! The holder is equipped with a bar guard for added rider protection & safety. The holder is heavy duty & extremely versatile holding a variety of chainsaws with bars up to 24" long.

- Universal bolt-on bracket fits most ATVs
- Attaches to both steel & composite racks
- Powder-coated in Jet Black
- Made in the USA
- Hardware & instructions included



PART #	DESCRIPTION
4501	Steel Chainsaw Holder



PART #	DESCRIPTION
2952	GPS / Light Beacon Pole

## Beacon Extension Pole

Raise safety lights or GPS globes off your ATV or UTV roughly 30 inches from your rack or bed. The 6" diameter variable mounting plate & grade 5 hardware allows for easy install, position adjustments & secures tightly into place once ready. Pole itself is manufactured from 1" tubing that attaches the top & bottom plate. Light not included.

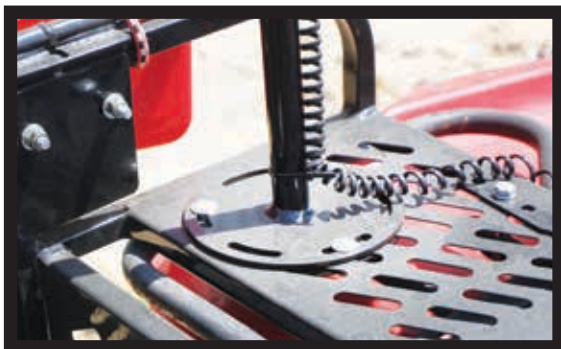

 **MADE IN  
USA**

# Receivers

Made in Minnesota, USA, with American steel these receivers are tough enough to tow through the roughest environments. With a Jet Black powder-coat finish, it will even hold up against corrosion & rust. Hardware & instructions included.

PART #	NAME	DESCRIPTION
4530	3-Way Compact Hitch	$\frac{3}{8}$ " steel laser cut with holes for a ball or pull pin & tow loops
4841	Bolt-On 2 Way Riser Hitch	$\frac{5}{16}$ " steel with 3" offset & a $\frac{1}{2}$ " thick tow loop
4533	3-Way 1 $\frac{1}{4}$ " Receiver	Bolts onto the frame with options for ball, clevis pin & tow loop, this reversible receiver puts your 1 $\frac{1}{4}$ " receiver to work with heavy gauge steel
4877	Bolt-On Hitch 1 $\frac{1}{4}$ " Receiver Converter	Easily attach to frame for converting to receiver hitch, 7-gauge welded mount plate & 12-gauge reinforced receiver tube
4890	Standard 1 $\frac{1}{4}$ " Receiver	$\frac{3}{8}$ " steel & fits a 1" ball bolt, includes receiver, $\frac{1}{2}$ " hitch pin & hair pin
4676	2-Way 1 $\frac{1}{4}$ " Receiver	$\frac{1}{2}$ " pin hole & a $\frac{3}{4}$ " ball bolt hole for using a ball or clevis pin without changing hitches, $\frac{1}{4}$ " steel with a 1" offset
4734	2" Offset 2-Way 1 $\frac{1}{4}$ " Receiver	$\frac{1}{2}$ " pin hole & a $\frac{3}{4}$ " ball bolt hole for using a ball or clevis pin without changing hitches, $\frac{1}{4}$ " steel with a 2" offset
4531	1 $\frac{1}{4}$ " to 2" Adapter Receiver	Change your 1 $\frac{1}{4}$ " receiver to a 2" without sacrificing strength, welded heavy duty steel with $\frac{1}{2}$ " hitch pin included
4532	3-Way 2" Receiver	Tow or pull as this reversible receiver has holes for a ball, pin & tow loop, includes a $\frac{5}{8}$ " hitch pin, reversible for varying heights
4895	4" Offset 2" Receiver	Heavy duty $\frac{3}{8}$ " steel 2" receiver with a 4" offset, includes hitch pin & hair pin

Note: All hitches & receivers include mounting hardware.



**#4841**  
BOLT-ON 2-WAY  
RISER HITCH



**#4877**  
BOLT-ON HITCH  
CONVERTER



**#4890**  
STANDARD  
1  $\frac{1}{4}$ " RECEIVER



**#4676**  
2-WAY  
1  $\frac{1}{4}$ " RECEIVER



**#4734**  
OFFSET 2-WAY  
1  $\frac{1}{4}$ " RECEIVER



**#4530**  
3-WAY COMPACT  
HITCH



**#4531**  
1  $\frac{1}{4}$ " TO 2"  
ADAPTER RECEIVER



**#4533**  
3-WAY 1  $\frac{1}{4}$ " RECEIVER

# Receiver Hitch Mounts

Mount our 2" receiver hitches directly to your frame without drilling! Manufactured from heavy grade steel & powder-coated with a Jet Black finish, it's sure to stand up to your toughest jobs. Receiver Hitch Mounts attach with ease to a variety of ATVs & UTVs.

- No drilling or plastic cutting
- Easy bolt-on install with included hardware & instructions
- Will not affect ground clearance

MODEL	YEARS	PART #
<b>CAN/AM</b>		
Maverick	13-14	5705
Outlander	06-14	5704
Renegade 800	07-11	5701
<b>HONDA</b>		
Foreman 500	04-13	5717
Rancher 350	00-06	5717
Rancher 400	04-07	5717
Rancher 420	07-13	5717
Rancher 420i	09-13	5716
Rincon 650	03-13	5716
Rubicon	00-13	5717
<b>JOHN DEERE</b>		
Gator HPX	04-13	5960

MODEL	YEARS	PART #
<b>KAWASAKI</b>		
Brute Force 750	11-13	5725
Mule 610	05-13	5761
<b>POLARIS</b>		
RZR 900 / RZR 900-4	12-14	5730
<b>SUZUKI</b>		
King Quad 500	11-13	5720
King Quad 750	08-13	5720
<b>YAMAHA</b>		
Big Bear 400i	07-12	5711
Grizzly 350	07-09	5711
Grizzly 350i	07-13	5711
Grizzly 400 / 450	07	5711
Grizzly 550	09-13	5712
Grizzly 700	08-13	5712
Kodiak 400i / 450i	06	5711



# ATV Accessories

## Hand Shifters

Whether you're wearing big boots, partially submerged or unable to operate a foot shifter, this clamp-around design will turn your foot shifter into a hand shifter in seconds. Easy mounting, sturdy construction, attaches to virtually any foot shifting machine & gives riding enthusiasts the ultimate gear-shifting experience no matter the situation!

- No drill assembly & easy bolt-on install
- 3/4" round American steel tubing
- Made in Minnesota, USA



PART #	DESCRIPTION
4632	Universal 15" Hand Shifter
4620	Universal 22" Hand Shifter
4698	20" Hand Shifter for Suzuki Models
4054	20" Hand Shifter for Yamaha YFM Big Bear 87-09



## License Plate Holder

Stay legal with this American made, steel license plate holder. With the included hardware, it attaches in seconds to any 1" or narrower tubing on the front or back of your ATV or UTV.

- Fits most 2 or 4 hole license plates
- 7 3/4" x 4" outside diameters, 11-gauge steel
- Includes 2 rubber coated steel clamps

PART #	DESCRIPTION
4541	Black License Plate Holder
4541W	White License Plate Holder



# Towing

## HitchDoc Utility Sled - #8100

Whether you're heading out to camp, ice fish, hunt or split wood, this steel framed utility sled will keep up! Effortlessly unfold, set up, load down & tow behind your snowmobile in deep snow or ATV/UTV over ice.

Easy, bolt together assembly allows this product to get right to work & it folds up for easy storage during the off season. Bring efficiency to your voyage with the HitchDoc utility sled.

- 45" x 24" deck space
- 9" x 24" perforated standing platform
- 33 1/2" tall & 93" long when fully set up
- 8 1/2" tall & 56" long when collapsed
- 3/4" square steel tube frame
- 14 gauge formed steel skis
- Rubber cushioned hitch with snow shield
- Some assembly required
- All hardware included

PART #	DESCRIPTION
8105	Replacement Ski
8130	Replacement Tongue & Hitch
8131	Replacement Hitch
8100	Folding Utility Sled



## Tie Down Bars & Cranks

Designed to work with more trailers. Being 45.6" wide, the tie down bars secure skis directly to the trailer. Powder-coated with a black finish then paired with rubber end caps to withstand the elements & not scratch machine skis. 1/2" center, crank hole pairs perfectly with either a 3 1/2" or 6 1/2" tie down crank.

- Center hole designed for 1/2" diameter cranks
- Cranks are 1/2" diameter & zinc coated
- Note: Bars & cranks are sold separately



PART #	DESCRIPTION
3327	1 1/4" square tie-down bar
3328	1" x 2" rectangle tie-down bar
3330	6 1/2" tie-down crank
3331	3 1/2" tie-down crank

# Motorcycle Hitches

Designed for **your bike**. Manufactured for **your safety**. Owner, Brad Mohns, designed & fabricated the first HitchDoc Motorcycle Hitch in preparation for the Sturgis Motorcycle Rally's 50th Anniversary in 1990. From the first hitch to the one you can purchase today, the philosophy behind using solid, American steel & matching the aesthetics of the bike has not changed.

- Standard (visible ball & mount plate) & vertical receiver style hitch mounts available
- Hitch mounts solidly to the frame without any drilling
- Innovative clatter-free receiver feature improves touring experience by not rattling with the vibrations of the road/bike
- Inspected against the highest quality standards for the safest addition to your riding experience
- Minnesota made with American steel & decades of manufacturing experience
- Visible portion of hitches are triple plated show chrome while some hidden portions are a baked-on, powder coat finish
- Designed & manufactured for safety & eye-appeal
- Hitches fit models of motorcycles across 10 brands & years 1980 to present
- Hole for ball is 3/4" & the receiver shaft is 1-1/8" with a 1-7/8" chrome ball

 **MADE IN  
U S A**





# Motorcycle Hitch Mounts

NAME	MODEL	YEARS	STANDARD	VERTICAL RECEIVER
<b>CVO</b>				
FXSTDSE	Deuce	03-04, 09	Call	-
FXDSE	Dyna	07-08	Call	-
FLHT-CUSE	Electra Glide Ultra Classic	06-12	Call	Call
FLSTFSE	Fat Boy	05-06	Call	Call
FLHTKSE	Limited/Ultra Limited Electra Glide	14-18	-	Call
FLTRSE	Road Glide	09, 18	-	Call
FLRXSE	Road Glide Custom	13	-	Call
FLTRUSE	Road Glide Ultra	11, 15-16	-	Call
FLHRSEI	Road King	02-03, 07-08, 13-14	Call	Call
FLHTCSE	Screamin Eagle Electra Glide	04-05	Call	Call
FLSTSE	Softail Convertible	10-12	-	Call
FLSTNSE	Softail Deluxe	14-15	-	Call
FXSTSSE	Softail Springer	07-09	Call	Call
FLHXSE	Street Glide	10-12 15-18	Call	Call
<b>DYNA/SUPER GLIDE</b>				
FXLR	Low Rider Custom	87-94	15020	-
FXR	Super Glide	82-86	15050	-
FXR	Super Glide	87-94	15020	-
FXRS	Super Glide	84	15020	-
FXRS	Super Glide - 5 Speed	84	15050	-
FXRS	Super Glide	85	15050	-
FXRS	Super Glide	86-88	15020	-
FXRT	Sport Glide	85-92	15040	-
FXRP	Super Glide	84-94	15020	-
FXRC	Low Rider Custom	85	15050	-
FXD	Dyna Super Glide	95-05	15070	-
FXD	Dyna Super Glide	06-10	15075	-
FXDL	Dyna Low Rider	95-05	15070	-
FXDX	Dyna Super Glide	99-05	15075	-
FXDB	Dyna Street Bob	06-08	15075	-
FXDWG	Dyna Wide Glide	93-05	15060	-
FXDWG	Dyna Wide Glide	06-08	15075	-
FXDF	Dyna Fat Bob	08	15085	-

NAME	MODEL	YEARS	STANDARD	VERTICAL RECEIVER
<b>ELECTRA GLIDE/ULTRA</b>				
FLHS	Electra Glide	80-08	15170	15180
FLHTC	Electra Glide Classic	83-08	15170	15180
FLHTC	Electra Glide Classic	09-13	-	15220
FLHT	Electra Glide Standard	83-08	15170	15180
FLHT	Electra Glide Standard	09-13	-	15220
FLHTCU	Electra Glide Ultra Classic	90-08	15170	15180
FLHTCU	Electra Glide Ultra Classic	09-13	-	15220
FLHTCU	Electra Glide Ultra Classic	14-18	-	15225
FLHTCUL	Electra Glide Ultra Classic Low	14-18	-	15225
FLHTK	Electra Glide Ultra Limited	10-13	-	15220
FLHTK	Electra Glide Ultra Limited	14-18	-	15225
FLHTKL	Ultra Limited Low	15-18	-	15225
<b>ROAD GLIDE</b>				
FLTR	Road Glide	98-08	-	15186
FLTR	Road Glide	09-13	-	15230
FLTRX	Road Glide	15-18	-	15225
FLTRX	Road Glide Custom	10-13	-	15214*
FLTRXS	Road Glide Special	15-18	-	15216*
FLTRU	Road Glide Ultra	09-13	-	15230
FLTRU	Road Glide Ultra	16-18	-	15225
<b>ROAD KING</b>				
FLHR	Road King	94-08	15170	15180
FLHR	Road King (No Rear Bumper)	94-08	15170	15186
FLHR	Road King	09-13	-	15220
FLHR	Road King	14-18	-	15225
FLHRCI	Road King Classic	00-08	15170	1518
FLHRCI	Road King Classic (No Rear Bumper)	00-08	15170	15186
FLHRC	Road King Classic	09-13	-	15220
FLHRS	Road King Custom	04-08	15170	15180
FLHRS	Road King Custom (No Rear Bumper)	04-08	15170	15186

Note:

\* = Horizontal receiver

\*\*=If no rear bumper, order part #15186

# Motorcycle Hitch Mounts

NAME	MODEL	YEARS	STANDARD	VERTICAL RECEIVER
<b>SOFTAIL</b>				
FXSTD	Deuce	00-06	15200	-
FXDF	Fatbob	06-08	15085	-
FLSTF	Fat Boy	90-99	15100	-
FLSTF	Fat Boy	00-06	15140	15155
FLSTF	Fat Boy	07-17	-	15116
FLSTFB	Fat Boy Lo	10-16	-	15116
FLSTFBS	Fat Boy Special	16-17	-	15116
FLST	Heritage Softail	06	15143	15158
FLSTC	Heritage Softail Classic	94-96	15110	-
FLSTC	Heritage Softail Classic	97-99	15120	-
FLSTC	Heritage Softail Classic	00	15141	15156
FLSTC	Heritage Softail Classic	01-02	15142	15157
FLSTC	Heritage Softail Classic	03-08	15143	15158
FLSTC	Heritage Softail Classic	09-17	-	15105
FLSTS	Heritage Springer	00-02	15144	15159
FLSTS	Heritage Springer	03-08	15145	15160
FXSTC	Softail Custom	88-05	15090	-
FXSTC	Softail Custom	06-08	15095	-
FLSTN	Softail Deluxe	05-08	15143	15158
FLSTN	Softail Deluxe	09-17	-	15105
FXSTS	Softail Springer	90-99	15130	-
FXSTS	Softail Springer	00-02	15144	15159
FXSTS	Softail Springer	03-08	15145	15160
FXST	Softail Standard	00	15141	15156
FXST	Softail Standard	01-02	15142	15157
FXST	Softail Standard	03-08	15143	15158
FLSTSC	Springer Classic	03-08	15145	15160
FXSTS	Springer Softail	00-02	15144	15159
FXSTS	Springer Softail	03-08	15145	15160
<b>SPORTSTER</b>				
XLH	Sportster	79-93	15000	-
XLH	Sportster	94-03	15010	-
XLH	Sportster	04-09	15015	-
<b>STREET GLIDE</b>				
FLHX	Street Glide	06-08	-	15175
FLHX	Street Glide	09	-	15210
FLHX	Street Glide	10-13	-	15214*
FLHX	Street Glide	14-18	-	15216*
FLHXS	Street Glide Special	14-18	-	15216*

Note: If you have added any aftermarket parts or made any modifications to your motorcycle, please call before ordering.

NAME	MODEL	YEARS	STANDARD	VERTICAL RECEIVER
<b>TRIKES</b>				
FLRT	FreeWheeler	14-18	-	15239
FLHT-CUTG	Tri-Glide (has to have threads)	09-11	-	15235
FLHT-CUTG	Tri-Glide (w/o threads)	11-18	-	15238
<b>BMW</b>				
K1200LT (Chrome)		99-09	15710	-
<b>HONDA</b>				
Goldwing 1500		88-00	-	15300
Goldwing 1500 with 1-1/2" Offset		88-00	-	15310
Goldwing 1800		00-10	-	15290
Goldwing 1800		12-15	-	15285
Goldwing 1800		18	-	15315
Magna 1100		94-03	15440	-
Shadow ACE 1100		87-00	15270	-
Shadow Spirit 1100		87-00	15270	-
Shadow ACE Tourer (Hard Bags)		98	15260	-
Shadow Aero 1100		85-07	15280	-
Valkyrie (Guard Rail)		98-13	15370	15420
Valkyrie (Hard Bags)		98-13	15350	15400
Valkyrie (Leather Bags)		98-13	15340	15390
Valkyrie (Leather-Lyke Bags)		98-13	15360	15410
Valkyrie (No Bags)		98-13	15330	15380
VTX 1300 Custom (Backrest & Luggage Rack)		04-09	15465	-
VTX 1300 (No Backrest & Luggage Rack)		04-09	15470	-
VTX 1300 Retro (Long Fender)		04-09	-	15480
VTX 1800 Custom (Backrest & Luggage Rack)		04-08	15465	-
VTX 1800 Custom (No Backrest & Luggage Rack)		04-08	15470	-
VTX 1800 Retro (Long Fender)		04-08	-	15480
<b>INDIAN</b>				
Chief		02-03	-	15900
Chief (Classic) (Dark Horse) (Vintage)		14-18	-	15910
Chieftain (Classic) (Elite) (Dark Horse) (Limited)		14-18	-	15910
Roadmaster (Classic) (Elite)		14-18	-	15910
Springfield (Dark Horse)		16-18	-	15910

# Motorcycle Hitch Mounts

MODEL	YEARS	STANDARD	VERTICAL RECEIVER
<b>KAWASAKI</b>			
Concours	86-06	-	15530
Vaquero	11-17	-	15820
Voyager 1200	86-03	-	15540
Voyager 1300	84-86	-	15550
Voyager 1700	09-17	-	15815
Vulcan 1500	87-08	-	15520
Vulcan 2000 (Saddle Bags)	04-17	-	15515
Vulcan 2000 (No Saddle Bags)	04-17	-	15516
Vulcan Classic LT	06-10	-	15514
Vulcan Classic 1500	07-17	15570	-
Vulcan Classic 1600	03-06	-	15505
Vulcan Nomad 1500	98-04	-	15510
Vulcan Nomad 1600	05-08	-	15525
Vulcan Nomad 1700	09-14	-	15815
<b>Moto Guzzi</b>			
California Moto Guzzi	96	15790	-
<b>SUZUKI</b>			
Boulevard C90T (No Bags)	05-10	-	15680 3
Boulevard C90T (Soft Bags)	05-10	-	15682
Boulevard C90T (Hard Bags)	05-10	-	15682
Intruder 1500 (No Bags)	98-04	-	15680 3
Intruder 1500 (Soft Bags)	98-04	-	15680 5
Intruder 1500 (Hard Bags)	98-04	-	15680 7
<b>TRIUMPH</b>			
Rocket III (Saddle Bags)	05-09	15990	-
Rocket III (No Saddle Bags)	05-09	15995	-
Rocket III Classic (Saddle Bags)	06-09	15990	-
Rocket III Classic (No Saddle Bags)	06-09	15995	-
Rocket III Roadster (Saddle Bags)	11-17	15990	-
Rocket III Roadster (No Saddle Bags)	11-17	15995	-

## MANUFACTURER WARNING

Do not exceed the motorcycle manufacturer's Gross Vehicle weight limit when loading and pulling ANY trailer with ANY motorcycle. ALL HitchDoc motorcycle trailer hitches have a MAXIMUM tongue weight load of 40 pounds. Tongue weight must NEVER EXCEED 10% of the GROSS TRAILER weight including ALL CONTENTS AND CARGO.

Motorcycle performance is always affected by adding a trailer to a motorcycle. Always ride in a conservative and safety conscience manner when towing a trailer with a motorcycle.

- Allow extra distance for acceleration and braking when pulling a trailer.
- Always decrease from normal cornering speeds when pulling a trailer with a motorcycle.
- When riding in groups with a motorcycle trailer, always ride at the

MODEL	YEARS	STANDARD	VERTICAL RECEIVER
<b>VICTORY</b>			
Cross Country	10-17	-	15780
King Pin (No Saddle Bags)	04-12	-	15775
King Pin (Saddle Bags)	04-12	-	15770
V92 C	98-03	15760	-
V92 TC	02-06	15760	-
V92C Deluxe	01-02	15760	-
Vision (No Arlen Ness Models)	07-17	-	15765
<b>YAMAHA</b>			
Road Star Silverado	99-14	15580	-
Road Star (Chrome Support Brackets)	99-14	15590	-
Roadliner	06-14	-	15585
Royal Star Classic	96-98	15610	-
Royal Star Tourer Deluxe	97-09	15600	15605
Royal Star Venture	99-13	15600	15605
Star Eluder (GT)	18		15665*
Star Venture (Transcontinental)	18		15665*
Stratoliner	06-15	-	15595
Virago 1100	86-99	15640	-
V-Star 1100 Classic	00-10	-	15660
V-Star 1100 Custom	98-11	15670	-
V-Star 1100 Silverado	04-10	-	15660
V-Star 1300 & Tourer	07-17	-	15625

rear of the group to minimize group accident exposure.

- Never exceed motorcycle manufacturer, trailer manufacturer, or hitch manufacturer's limits for gross weight or tongue weight.
- Never exceed posted speed limits for vehicles when pulling trailers which can be different than non-towing vehicles.
- Many states exclude, by law, vehicles towing trailers from the left hand, or so-called fast lanes.
- Always use approved safety chains, and have them securely attached. Cross the safety chains under the tongue of the trailer so that the tongue will not drop to the road if it becomes separated from the hitch. Always leave just enough slack so that you can turn with your rig. And, never allow safety chains to drag on the ground.
- Trailer tire pressure should be inflated to maximum allowable pressure, unless otherwise recommended by the trailer manufacturer. Rear motorcycle tire pressure should be inflated to maximum allowable pressure (refer to tire side wall marking) and checked periodically.
- Towing a trailer requires a certain amount of experience. After loading the trailer, weigh the trailer and then the tongue separately, to see if the weights are proper.
- If trailer sways or bounces while towing, SLOW DOWN BY REDUCING SPEED GRADUALLY and STOP TOWING immediately. Unless cause can be determined, i.e. shifted load, low tire pressure, etc., which can be corrected, do not resume towing.

\*Our hitches are designed to fit on stock bikes.

\*Our hitches are not recommended for use with one wheeled trailers.

# Snowmobile Tools

## Snowmobile Shop Dolly - #8010

Originally designed in 1966 & redesigned in recent years, this patented collapsible Shop Dolly will make snowmobile moving a breeze! The U-shaped handle design & adjustable strap will hook to your machine & easily move it inside the shop or out on the trailer with the large, steel rimmed rubber tires.

This Shop Dolly can be stood upright on its 'feet' or collapsed down for simple storage in the off-season.

- Built from steel tubing
- Reinforced with 2 pairs of 1" wide, 7-gauge steel braces
- Pneumatic tires with steel rims
- Accommodates sleds ranging from 38" to 51" wide
- Adjustable legs, arms & strap
- Some assembly required



PART #	DESCRIPTION
8010-1	Shop Dolly pad, rod & pin replacement part
8015	Shop Dolly wheel replacement

PART #	DESCRIPTION
8018	Shop Dolly lift strap with hook replacement

## Snowmobile Work Stand - #8030

The work stand is the ultimate addition to a snowmobile enthusiast's shop or garage. With enough lift to raise any sled, yet collapses down for off-season storage. This work stand is perfect for replacing the track, changing carbides, adjusting suspension, sled storage & more!

The Snowmobile Work Stand was designed in the snowy Midwest with strong, rectangular tubing, manufactured in the USA & finished with a corrosion resistant, powder-coat finish.

- Lifts to roughly 31" & collapses to 5 1/2"
- Legs & top composed of 1 1/2"x1" steel tubing
- Base composed of 2"x1" steel tubing
- Long handled crank jack makes for easy lifting
- 4" diameter circular lifting pads
- Grade 5 hardware included
- Some assembly required
- Optional wheel kit available (Part #8035 shown in photo)



PART #	DESCRIPTION
8035	Work Stand non-locking, swivel wheel kit
8032	Work Stand rubber lift pad replacements

PART #	DESCRIPTION
8028	Work Stand replacement jack
8031	Work Stand replacement crank jack handle

# Snowmobile Tools

## Stands & Slides

Make moving & storing your snowmobile a breeze with any sled slides or steel track risers. Easily lift your track for maintenance or storage with three styles of adjustable track stands. Secure the stand at the proper height for an easy, one-person lift. Warm Up Stand (8072) & Lever Lift Stand (8074) provide a full shield from any track debris when servicing.

Sled slides come in steel or colored, formed plastic; pick from black, blue or red. Slides come as a set of three with two designed for the skis & one for underneath the track. Move machines across smooth surfaces alone & for precise placement.

PART #	DESCRIPTION
8058	Blue Plastic Sled Slides
8056	Black Plastic Sled Slides
8060	Red Plastic Sled Slides
8070	Steel Sled Slides
8074	Lever Lift Stand
8072	Warm Up Stand
8040	EZ Trac Stand



#8070 STEEL SLED SLIDES



#8072 WARM UP STAND



#8074 LEVER LIFT STAND

## Clutch Pullers

Clutch pullers are made from high carbon, hardened steel & machined to precise tolerances, providing years of durable shop use for many makes & models of snowmobiles. Simply prep the clutch, twist the puller into place & use a matching socket for easy removal. Heavy-duty steel with a black oxidized finish.

Clutch Button Retainer Clips come as a set of three & an integral part of removing the clutch on Ski-Doo T.R.A. machines. Steel & zinc coated clips hold buttons in place during assembly & disassembly.

PART #	DESCRIPTION
9320	Clutch Button Retainer Clips (3)
9321	Arctic Cat Clutch Puller - 9 bolt -Fits newer Arctic Cat clutches
9322	Arctic Cat/Comet Clutch Puller -Fits all Arctic Cat clutches
9323	Polaris Clutch Puller -99-01 XCR 700/800 Fuji -00-01 Domestic Twins 500/600/700/800 -99-01 Edge Pro X 440
9324	Polaris Clutch Puller -97-99 Domestic Twins 440/500/600/700

PART #	DESCRIPTION
9325	Polaris/Comet Clutch Puller
9327	Ski-Doo T.R.A Clutch Puller -Through 2004 -95 MXZ, all 670 & all triples
9328	Ski-Doo T.R.A Clutch Puller -94 MXZ, all 583 engines & most MX's
9329	Yamaha Clutch Puller -86 & newer YPZ-YXR
9332	Ski-Doo E-Tek Clutch Puller

#9321

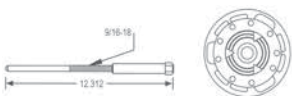

#9322

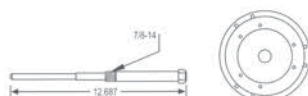

#9323



#9324



#9325



#9327 & #9332



#9328



#9329



# DirtMaster

Tow around the field, through the woods, or a suburban backyard with an ATV, car, lawn tractor, truck or UTV. The DirtMaster by Kwik-Way is the ultimate towable backhoe! With unlimited mobility, minimal ground disturbance during operation & easy to master joysticks, any operator can hop on & get right to work. The DirtMaster comes standard with two pairs of stabilizers & a best-in-class Honda motor. It's sure to make short work of your next project!

- Tow at speeds up to 45 mph depending on terrain
- 2" solid ball & lock pins ensure safe transportation
- Front hydraulic stabilizer can be positioned together or independently
- Rear manual stabilizers can be secured with a pin during use or transport

**CONQUER ANY TERRAIN** with the ultimate **TOWABLE BACKHOE!**



**DIRTMASTER**

PART #	DESCRIPTION
KW55-32710	DirtMaster with 12" bucket
KW53-00121	9" Bucket
KW53-00321	16" Bucket
KW53-01511	14" Ripper Tooth
KW53-01611	Fenders & Light Kit

# Other Leading Products

## Finish Graders



Minimize material & labor costs while prepping your jobsite with the automated Dual Dozer. Attach to tractors or skid loaders with various technology options.

## Spreaders



Scoop sand, salt, seed or fertilizer with the hardened cutting edge of the hydraulically powered Sandpiper Spreader. Spread widths of 30 inches up to 30 feet.

## Kwik-Way Blades



### V-Blade

Move snow or light material with the Kwik-Way V-Blade. Position each hydraulic panel for V forward, backwards or straight.

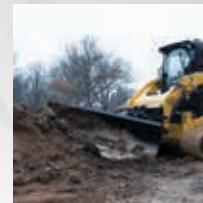

### 6-Way Blade

Have ultimate control over the heavy duty, hydraulically powered Kwik-Way 6-Way Blade. Tackle heavy dirt work, rock or snow!



### Angle Blade

Ready to handle snow or light material work, the Kwik-Way Angle Blade easily attaches to skid steers & mini skids.

## Fuel Transportation



### Fuel Pod

Transport fuel in your truck bed or on a seed cart to finish out a job or field! Dual skid pockets allow for easy mobility.



### Fuel Trailers

Transport fuel to the jobsite or field with the road-ready, DOT compliant HitchDoc Fuel Carts. Multiple options available to best fit each application.

## Contract Manufacturing



With 2 facilities, 150 employees & truckloads of US steel, HitchDoc is a high-caliber & full-service manufacturing partner. Sheet, tube & plate processing, welding, machining, forming, powder-coat paint, stocking, shipping & complete assemblies are only a few of the exceptional capabilities offered. No project is too large or small for this family-owned & operated business.



## Seed Carts



With over 30 models available of bulk or box seed carts with auger or conveyor options, Travis Seed Carts are overbuilt to outlast the competition.

## Ejector Buckets



The patent-pending Push-Off Bucket is a proven workhorse for moving dense/sticky materials. Forget shaking & slamming your bucket while adding height & reach to your dump!

## SnowBlowers



### Tractor

Chew up & throw snow over the tree tops with single, double or triple auger models in the toughest conditions year after year with the PTO HitchDoc SnowBlower.



### Skid Steer

Full hydraulic controls make snow blowing a breeze! Easily attaches to skid steers & made from US Prime steel.



### Wheel Loader

100% hydraulic snow blower seamlessly controlled from the cab of the pay loader. No external engines, gearboxes or shear pins!

# Order Guides

## Original Eagle Plow System

With years of 'in-the-field' engineering, the Original Eagle Mid-Mount Plow System is ready to plow through snow, no matter how much stands in your way. The mount & push tubes mount to the belly of your ATV. Use any Eagle Plow Blade with this system (except the 2960 Series V-Plow).

ORDER GUIDE

- Review the Model Specific Mount Guide (Pages 13-19) ..... Part # \_\_\_\_\_  
\*\*Note: Universal Push Tube Mount is included with Model Specific Mounts
- Order the Original Eagle Push Tube ..... Part # 2906
- Select your Eagle Plow Blade (Pages 6-7) ..... Part # \_\_\_\_\_
- Optional Lifting Accessory: Hand Lift Kit (Page 22) ..... Part # \_\_\_\_\_
- Optional Lifting Accessory: Winch (Pages 24-25) ..... Part # \_\_\_\_\_
- Optional Lifting Accessory: Winch Mount (Pages 13-19) ..... Part # \_\_\_\_\_

## Eagle Gen. II Plow System

Easily mount to the front of your ATV with the Eagle Gen. II Front Mount Plow System. Each mount is made specifically for your machine with push tubes to match either tires or tracks. This system works with any Eagle Plow Blade (except the 2960 Series V-Plow).

ORDER GUIDE

- Review the Model Specific Mount Guide (Pages 13-19) ..... Part # \_\_\_\_\_
- Order the proper Gen. II Push Tube ..... Part # \_\_\_\_\_  
Standard Push Tube for Tires: Part # 3906  
Extended Push Tube for Tracks: Part # 3908
- Select your Eagle Plow Blade (Pages 6-7) ..... Part # \_\_\_\_\_
- Optional Lifting Accessory: Winch (Pages 24-25) ..... Part # \_\_\_\_\_
- Optional Lifting Accessory: Winch Mount (Pages 13-19) ..... Part # \_\_\_\_\_

## Eagle UTV Plow System

Smash through snow with your UTV & the Eagle UTV Front Mount Plow System. Each mount is made specifically for your make/model & mounts to the front of your machine. Mount & push tubes are made to work with any Eagle Plow Blade (except the 2960 Series V-Plow).

ORDER GUIDE

- Review the Model Specific Mount Guide (Pages 13-19) ..... Part # \_\_\_\_\_
- Order the proper Eagle UTV Push Tube ..... Part # \_\_\_\_\_  
Standard Push Tube for Tires: Part # 2805  
Extended Push Tube for Tracks: Part # 2808
- Select your Eagle Plow Blade (Pages 6-7) ..... Part # \_\_\_\_\_
- Optional Lifting Accessory: Winch (Pages 24-25) ..... Part # \_\_\_\_\_
- Optional Lifting Accessory: Winch Mount (Pages 13-19) ..... Part # \_\_\_\_\_



# Mount Guides

MODEL	YEAR	MID-MOUNT	FRONT MOUNT	WINCH MOUNT
<b>ARCTIC CAT</b>				
<b>ATV</b>				
250 2x4, 4x4	99-05	2010	-	1005
300 2x4, 4x4	98-01	2010	-	1005
300 2x4, 4x4	02-04	2010	-	1010
300 2x4, 4x4	05	2010	-	1005
350 4x4 (CR)	12	2012	-	-
366 4x4	08-09	2012	-	1012
400 2x4, 4x4	96-01	2010	-	1005
400 2X4, 4X4 (ACT) (I)	02-05	2010	-	1010
400 2x4, 4x4	06-08	-	3950	FIM
400 Automatic 2x4, 4x4 (LE)	03-08	2010	3950	1010
400 Automatic 4x4 ACT	03-04	2010	3950	-
400 Automatic 4x4 TBX	04	2010	3950	-
400 Automatic 4x4 TBX	05-06	2010	3950	FIM
400 Automatic 4x4 TRV	06-12	2010	-	FIM
400 Automatic 4x4 TRV	13	2010	3950	FIM
400 Automatic 4x4	14	2010	3950	FIM
450 4X4	10-12	2010	3950	1015
454 2x4 / 4x4	98	2010	-	1005
500 4x4	96-01	2010	-	1005
500 4x4	02-04	2010	-	-
500 4x4	05-14	2010	3950	-
500 AUTO	00-02	2020	-	1005
500 TBX 4x4	02-06	2010	3950	FIM
500 TRV 4x4	03-05	2010	-	-
500 TRV 4x4	06-16	2010	3950	FIM
500i	96-02	2010	-	1005
550 4x4	09-14	2010	3950	1015
550 Alterra 4x4	16	2014	3951	FIM
550 Alterra TRV 4x4	17	2014	3951	FIM
550 TRV 4x4	09-16	2010	3950	FIM
550 XR 4x4	15	2014	3951	FIM
650 4x4	04-05	2010	-	-
650 4x4	06-11	2010	3950	-
650 TRV 4x4	07-11	2010	-	FIM
700 4x4 (AUTO) (AUTO EFI) (M4) (H1 SE)	06-16	2010	-	1015
700 Alterra 4x4 (XT)	16-17	2014	3951	FIM

MODEL	YEAR	MID-MOUNT	FRONT MOUNT	WINCH MOUNT
700 Alterra TRV 4x4	17	2014	3951	FIM
700 Diesel	06-16	2010	-	1015
700 Mud Pro	06-08	2010	-	1015
700 Mud Pro	09-17	2010	3950	-
700 TBX 4x4	06	2010	-	FIM
700 TBX 4x4	07-17	2010	3950	FIM
700 TRV 4x4	06-16	2010	3950	FIM
700 VLX	17	2010	3950	FIM
700 XR 4x4	15	2014	3951	FIM
1000 4x4	08-17	2015	3950	FIM
1000 TRV 4x4	09-17	2015	3950	FIM
1000 Thundercat H2 (LE) 4X4	08-10	-	3950	FIM
<b>UTV; SxS</b>				
500 Prowler	17	N/A	2865	-
500 Prowler HDX	14-15	N/A	2860	-
500 Prowler HDX	16-17	N/A	2864	FIM
550 Prowler (XT)	09-14	N/A	2860	1860
550 Prowler (XT)	15	N/A	2864	-
650 Prowler H1 XT 4X4	06-09	N/A	2860	1860
700 Prowler (XTX)	08-14	N/A	2860	1860
700 Prowler	15-17	N/A	2864	FIM
700 Prowler HDX	16-17	N/A	2864	FIM
700 Prowler HDX Crew	17	N/A	2864	FIM
1000 Prowler XTZ 4X4	10-14	N/A	2860	1860
1000 Prowler	15-16	N/A	2864	FIM
Wildcat Sport	14-17	N/A	2866	FIM
Wildcat Trail	14-17	N/A	2866	FIM
<b>ARGO</b>				
500 Xplorer XR (LE)	18	2180	3980	1180
500 Xplorer XRT (LE)	18	2180	3980	1180
<b>BOBCAT</b>				
<b>UTV; SxS</b>				
3200 Series	11-14	N/A	2859	1859
3400 4X4	12-14	N/A	2859	1859
3400 4X4	15-18	N/A	2885	-
<b>CAN-AM</b>				
<b>ATV</b>				
330 Outlander 2x4, 4x4 (XT)	03-05	2110	-	1110

# Mount Guides

MODEL	YEAR	MID-MOUNT	FRONT MOUNT	WINCH MOUNT
330 Outlander Max 4x4 (XT)	03-05	2110	-	1110
400 Outlander 4X4 (XT)	03-05	2110	-	1110
400 Outlander 4X4 (XT)	06-12	2111	3911	1112
400 Outlander 4X4 (XT)	13-14	2115	3911	1112
400 Outlander 4X4 (XT)	15	2115	-	1112
400 Outlander Max 4x4 (XT)	06-12	-	-	1112
400 Outlander Max 4x4 (XT)	13	2115	3919	1112
400 Outlander Max 4x4 (XT)	14-15	2115	-	1112
450L Outlander (XT)	15-16	-	3928	FIM
450L Outlander MAX (XT)	15-16	-	3928	FIM
450 Outlander (XT)	17-18	-	3928	FIM
450 Outlander MAX (XT)	17-18	-	3928	FIM
500 Outlander (XT)	07-12	2111	3911	1112
500 Outlander (XT)	13-15	2115	3919	1112
500 Outlander 4x4 MAX (XT)	13-15	2115	3919	-
500 Quest	02-04	2105	-	1105
500 Traxter	99-05	2105	-	1105
570 Outlander (XT)	16-17	-	3928	1112
570 Outlander (XT)	18	-	3928	-
570 Outlander MAX (XT)	16-17	-	3928	1112
570 Outlander MAX (XT)	18	-	3928	-
570L Outlander (XT)	16	-	3928	-
570L Outlander MAX (XT)	16	-	3928	-
570 Renegade 4x4 XC, X XC	16-18	2115	-	-
650 Outlander 6x6	13-17	2115	-	-
650 Outlander (XT)	06-12	2111	3911	1112
650 Outlander (XT)	13-18	2115	3919	-
650 Outlander MAX (XT)	06-12	2111	-	1112
650 Outlander MAX (XT)	13-18	2115	3919	1112
650 Quest	02-04	2105	-	1105
800 Outlander (XT)	06-11	2111	3911	-
800 Outlander (XT)	12-15	2115	3919	1112

MODEL	YEAR	MID-MOUNT	FRONT MOUNT	WINCH MOUNT
800 Outlander MAX (XT)	06-12	2112	3911	1112
800 Outlander MAX (XT)	13-15	2115	3919	1112
800R Outlander (XT)	11	2111	3911	1112
800R Outlander (XT)	12	2115	3912	1112
800R Outlander (XT)	13-15	2115	3919	-
800R Outlander MAX (XT)	11-12	2111	-	1112
800R Outlander MAX (XT)	13-15	2115	3919	-
800 Renegade	07-11	2111	-	1115
850 Outlander (XT)	16-18	2115	3919	-
850 Outlander (XT)	19	2115	-	-
850 Outlander MAX (XT)	16-18	2115	3919	-
850 Renegade (G2)	16-17	2115	-	-
1000 Outlander 4x4 (XT)	13-18	2115	3919	1112
1000 Outlander MAX 4x4 (XT)	13-18	2115	3919	1112
1000 Renegade (G2)	12-18	2115	-	-
<b>UTV; SxS</b>				
500 Defender HD5	17-19	N/A	2809	FIM
800 Commander	11-17	N/A	2811	1811
800 Defender HD8	16-19	N/A	2809	FIM
1000 Commander	11-17	N/A	2811	1811
1000 Defender HD10	16-19	N/A	2809	FIM
1000 Maverick	13-17	N/A	2810	1810
<b>CF MOTO</b>				
<b>ATV</b>				
500 Cforce	13-14	2070	-	-
600 Cforce	13-14	2070	-	-
800 Cforce	13-16	2070	-	FIW
X-5 (LWB) (SWB)	12-14	2070	-	-
X-6 (LWB) (SWB)	12-14	2070	-	-
X-8 (LWB) (SWB)	12-14	2070	-	-
<b>UTV; SxS</b>				
500 Uforce	16-17	N/A	2872	FIW
600 Rancher (EFI)	12-13	N/A	2870	-
800 Uforce	13	N/A	2872	-
800 Uforce	14-18	N/A	2872	FIW
800 Zforce EX	14-17	N/A	2869	FIW

# Mount Guides

MODEL	YEAR	MID-MOUNT	FRONT MOUNT	WINCH MOUNT
<b>CUB CADET</b>				
<b>UTV; SxS</b>				
550 Challenger (MX)	17-18	N/A	FIM*	FIW
700 Challenger	15	N/A	2823	-
750 Challenger (MX)	17-18	N/A	FIM*	FIW
Tracker	07-09	N/A	2822	1822
Tracker	10-14	N/A	2822	-
Volunteer	07-14	N/A	2822	1822
*Factory installed plow mount is compatible with Eagle Plow system push tubes and blades. No additional mount needed.				
<b>HONDA</b>				
<b>ATV</b>				
TRX 300	88-92	2215	-	-
TRX 300	93-00	2215	-	1240
TRX350 Rancher	00-03	2210	3922	1220
TRX350 Rancher	04-06	2210	3923	1220
TRX400 Foreman	95-04	2210	-	1215
TRX400 Rancher	00-03	2210	-	1220
TRX400 Rancher	04-07	2210	3923	1220
TRX420 Rancher 2x4, 4x4 (All Models)	07-13	2230	3926	1225
TRX420 Rancher 4X4 "IRS ONLY"	14	2230	3926	1225
TRX420 Rancher 4X4 "SOLID AXLE ONLY"	14	2237	3927	1234
TRX420 Rancher 2x4, 4x4 (All Models)	15-17	2237	3927	1234
TRX420 Rancher 2x4, 4x4 (All Models)	18	-	3927	1234
TRX450 Foreman	95-97	2210	-	1215
TRX450 Foreman	98-04	2210	3924	1215
TRX450 Rubicon	98-04	-	3924	1215
TRX500 Foreman	05-06	2225	3925	1230
TRX500 Foreman	07-11	2225	3925	1235
TRX500 Foreman S/ES/FPE	12-13	2236	-	1236
TRX500 Foreman (All Models)	14-17	2237	3927	1234
TRX500 Foreman (All Models)	18	-	3927	1234
TRX500 Rubicon (All Models)	01-04	2205	-	1210
TRX500 Rubicon (All Models)	05-06	2205	3925	1230

MODEL	YEAR	MID-MOUNT	FRONT MOUNT	WINCH MOUNT
TRX500 Rubicon (All Models)	07-14	2205	3925	1235
TRX500 Rubicon (All Models)	15-18	2206	3927	1234
TRX650 Rincon	03-05	2205	3905	1230
TRX680 Rincon	06-17	2205	3905	1230
<b>UTV; SxS</b>				
500 Pioneer	15-17	N/A	2839	1839
700 Big Red MUV	09-13	N/A	2815	1815
700 Pioneer	14-18	N/A	2838	1838
700 Pioneer 4	14-18	N/A	2838	1838
1000 Pioneer	16-18	N/A	2845	1844
1000 Pioneer 5	16-18	N/A	2845	1844
<b>JOHN DEERE</b>				
<b>ATV</b>				
500 Buck	04-06	2105	-	-
500 Trail Buck	04-05	2105	-	-
650 Buck	04-06	2105	-	-
650 Trail Buck	04-05	2105	-	-
<b>UTV; SxS</b>				
Gator 6X4	93-14	N/A	2831	1831
Gator HPX	04-12	N/A	2830	1831
Gator HPX	13-15	N/A	2830	-
550 Gator XUV	12-17	N/A	2833	1834
550 Gator XUV S4	12-17	N/A	2833	1834
560 Gator XUV	16-17	N/A	2833	1834
560 Gator XUV S4	16-17	N/A	2833	1834
590 Gator XUV	16-17	N/A	2833	1834
590 Gator XUV	18	N/A	2833	FIW
590 Gator XUV S4	16-17	N/A	2833	1834
620i Gator XUV	07-10	N/A	2830	-
625i Gator XUV	11-15	N/A	2832	1832
825i Gator XUV	11-17	N/A	2832	1832
825i Gator XUV S4	13-17	N/A	2832	1832
835 Gator XUV	18	N/A	2829	-
850i Gator RSX	12-15	N/A	2834	1834
860 Gator RSX (i) (E) (M)	16-18	N/A	2834	-
850D Gator XUV	07-10	N/A	2830	-
855D Gator XUV	11-15	N/A	2832	1832
855D Gator XUV S4	11-15	N/A	2832	1832

# Mount Guides

MODEL	YEAR	MID-MOUNT	FRONT MOUNT	WINCH MOUNT
<b>KAWASAKI</b>				
<b>ATV</b>				
250 Bayou	05	2335	-	-
300 Bayou	89-03	2320	-	1330
300 Prairie	99-02	2325	-	-
360 Prairie	02-12	2315	-	1320
400 Prairie	97-02	2325	-	1310
650 Brute Force	05-11	2315	-	1315
650 Brute Force	12-13	2315	-	-
650i Brute Force	06-09	2330	-	1340
650i Brute Force	10	2330	-	-
650i Brute Force	11	2330	3931	1341
650i Brute Force	12	2330	-	1341
650i Brute Force	13	2330	-	-
650 Prairie	02-04	2315	-	1305
700 Prairie 4x4	04-06	2315	-	1335
750i Brute Force	05-07	2330	-	-
750i Brute Force	08-14	2330	3931	1341
750i Brute Force	15-18	2330	3931	1316
<b>UTV; SxS</b>				
600 Mule	05-16	N/A	2840	1840
610 Mule	05-16	N/A	2840	1840
750 Teryx (RUV)	08-13	N/A	2842	1842
750 Teryx 4	12-13	N/A	2843	1843
800 Teryx (LE)	14-17	N/A	2843	1843
800 Teryx (LE)	18	N/A	2843	-
800 Teryx 4 (LE)	14-17	N/A	2843	1843
800 Teryx 4 (LE)	18	N/A	2843	-
820 Mule Pro FX	16-18	N/A	2863	1862
820 Mule Pro FXR	18	N/A	2863	1862
820 Mule Pro FXT	15-17	N/A	2863	1862
1000 Diesel Mule Pro (DXT) (DX)	16-17	N/A	2863	1862
3000 Mule	01-08	N/A	2820	FIM
3010 Mule	01-08	N/A	2820	FIM
4000 Mule	09-11	N/A	2821	-
4000 Mule (TRANS)	12-18	N/A	2821	1821
4010 Mule	09-11	N/A	2821	-
4010 Mule (SE) (TRANS)	12-18	N/A	2821	1821
<b>KIOTI</b>				
<b>UTV; SxS</b>				
2200 Mechron	14	N/A	2880	1880
2200 Mechron	15	N/A	2880	-

MODEL	YEAR	MID-MOUNT	FRONT MOUNT	WINCH MOUNT
<b>KUBOTA</b>				
<b>UTV; SxS</b>				
400ci RTV 4X4	12-16	N/A	2814	1814
500 RTV 4X4 (2" Receiver)	09-16	N/A	2814	1814
900 RTV 4X4 (1-1/4" Receiver)	04-09	N/A	2814	1812
900 RTV 4X4 (2" Receiver)	10-16	N/A	2813	1813
900 RTV 4X4 (Rect. Tube Bumper)	11-12	N/A	2814	-
1100 RTV 4X4 (1-1/4" Receiver)	08-10	N/A	2814	1812
1100 RTV 4X4 (Rect. Tube Bumper)	11-12	N/A	2814	1816
1140 RTV 4X4 Crew (2" Receiver)	10-16	N/A	2813	1813
900 RTV-X	14-18	N/A	2814	FIM
1100C RTV-X	14-17	N/A	2814	FIM
1120D RTV-X	14-17	N/A	2814	FIM
<b>KYMCO</b>				
<b>UTV; SxS</b>				
450i UXV (LE) (LE Prime) (LE Hunter)	15-18	N/A	2865	FIM
500i UXV 4X4	12-18	N/A	2855	FIM
700i UXV (LE) (LE EPS) (LE Prime) (LE Hunter)	14-18	N/A	2855	FIM
<b>ODES</b>				
<b>UTV; SxS</b>				
800 Dominator (2 & 4 Door)	13-16	N/A	2867	
800 Dominator X2	15-16	N/A	2868	-
800 Dominator X4	15-16	N/A	2868	-
1000 Dominator	15-16	N/A	2867	
1000 Dominator X2	15-16	N/A	2868	-
1000 Dominator X4	15-16	N/A	2868	-
<b>POLARIS</b>				
<b>ATV</b>				
300 4X4	94-95	2420	-	-
300 Hawkeye	06-07	2425	-	1425
300 Sportsman	08-10	2425	-	1425
330 ATP	04-05	2410	-	1410
330 Magnum 4x4	03-06	2410	-	1410

# Mount Guides

MODEL	YEAR	MID-MOUNT	FRONT MOUNT	WINCH MOUNT
400 Hawkeye	08-09	2425	-	1425
400 Hawkeye	10	2425	-	-
400 Sportsman	01-04	2405	-	1410
400 Sportsman	05	2405	3938	1415
400 Sportsman	06-07	2405	-	1415
400 Sportsman	08-09	2425	-	1425
400 Sportsman	10	2425	-	-
400 Sportsman	11-14	2405	3937	1413
425 Magnum	94-98	2420	-	-
450 Sportsman	05	2405	-	-
450 Sportsman	06	2405	3938	-
450 Sportsman (H.O.)	16-18	2411	3942-REV A	1413
500 ATP	04-05	2410	-	1410
500 Sportsman	96-97	2410	-	-
500 Sportsman	98-03	2405	-	1410
500 Sportsman	04	2405	-	1407
500 Sportsman	05-10	2405	3938	1415
500 Sportsman	11-13	2405	3937	1413
500 Sportsman	14	-	3937	1413
500 Sportsman 6X6	92	2410	-	-
500 Sportsman Touring	08-09	2410	-	1415
500 Sportsman Touring	12	2405	-	1413
500 Sportsman X2	06	2425	-	1415
500 Sportsman X2	07-08	2412	3938	1415
500 Sportsman X2	09	2410	3938	1415
550 Sportsman	09	2414	-	-
550 Sportsman	10-14	2414	3940	1414
550 Sportsman Touring	10-14	2414	-	-
550 Sportsman X2	10-14	2414	3940	1414
550 Sportsman XP	09-11	-	3940	1414
570 Sportsman	14	2411	3937	1413
570 Sportsman	15-18	2411	3942-REV A	1413
570 Sportsman (SP)	15-18	2411	3942	1413
570 Sportsman Touring	14	2411	3937	1413
570 Sportsman Touring	15-18	2411	3942-REV A	1413
570 Sportsman X2	15-18	2411	3942-REV A	1413
570 Sportsman 6x6	18	2411	-	1413
600 Sportsman	02-04	2410	-	1407
600 Sportsman	05-07	2410	-	1415
700 Sportsman	02-04	2410	-	1407

MODEL	YEAR	MID-MOUNT	FRONT MOUNT	WINCH MOUNT
700 Sportsman	05-08	2410	-	1415
700 Sportsman X2	08	2412	-	1415
800 Sportsman	05-10	2410	-	1415
800 Sportsman	11	2405	-	1413
800 Sportsman	12-14	2405	3937	1413
800 Sportsman Big Boss 6X6	12	2405	-	1413
800 Sportsman Touring	08-09	2410	-	1415
800 Sportsman X2	07	2412	-	1415
800 Sportsman X2	09	2410	3938	1415
850 Scrambler	13-17	2414	-	1414
850 Scrambler XP	13-14	-	3941	1414
850 Sportsman	09-14	2414	3940	1414
850 Sportsman	15-18	2414	-	1414
850 Sportsman Touring	10-14	2414	3940	1414
850 Sportsman Touring (SP)	15-18	2414	-	1414
850 Sportsman X2	10	2414	-	1414
850 Sportsman X2	11	2414	3938	1414
1000 Scrambler XP	14-17	2414	-	1414
1000 Sportsman XP	15-18	2414	-	1414
1000 Sportsman Touring XP	15-18	2414	-	1414
Diesel 4X4	99-01	2405	-	-
Sportsman	93-95	2420	-	1400
Sportsman 6X6	91-99	2420	-	1400
Sportsman 6X6	00-06	2420	-	-
Sportsman ETX	15	-	3942-REV A	1413
Sportsman Twin (All CC'S)	05-09	-	3939	-
Xplorer 400 (Chain Drive)	96-98	2409	-	1400
Xplorer 400 (Shaft Drive)	98-02	2410	-	1410
Xplorer 400L (Shaft Drive)	96-97	2410	-	1410
Xplorer 500 (Shaft Drive)	97	2410	-	1410
<b>UTV; SxS</b>				
400 Ranger 4X4 Midsize	10-14	N/A	2847	1847
500 Ranger 4X4 Midsize (Crew)	11-13	N/A	2847	1847
500 Ranger 4X4 Midsize	17-18	N/A	2857	1847

# Mount Guides

MODEL	YEAR	MID-MOUNT	FRONT MOUNT	WINCH MOUNT
570 Ranger 4X4 Midsize (2-Seater)	14-18	N/A	2857	1857
570 Ranger 4X4 Midsize Crew (4-Seater)	14-18	N/A	2857	1857
570 Ranger Full Size (3-Seater)	15	N/A	2856	1854
570 Ranger Full Size (3-Seater) 4x4 (Round Tube/800 Body Style)	16-18	N/A	2857	1857
570-6 Ranger Full Size Crew (6-Seater) 4x4 (Round Tube/800 Body Style)	16-18	N/A	2857	1857
570 RZR	12-17	N/A	2852	1852
700 Ranger	09	N/A	2846	-
700 Ranger Full Size Crew	08-09	N/A	2850	1850
700 Ranger Full Size Crew	10-11	N/A	2851	-
800 Ranger 4X4 Midsize (2-Seater)	13-14	N/A	2857	1847
800 Ranger Full Size 4x4 [3-Seater] (XP) (HD)	10-14	N/A	2851	1851
800 Ranger Full Size 4x4 Crew [6-Seater]	10-14	N/A	2851	-
800 RZR	08-14	N/A	2852	1852
800 RZR-4	10-14	N/A	2852	1852
900 RZR	11-14	N/A	2853	1853
900 RZR	15-18	N/A	2858	1858
900 RZR-4	11-14	N/A	2853	1853
900 RZR-4	15-17	N/A	2858	1858
900 RZR S	15-18	N/A	2858	1858
900 RZR S-4	18	N/A	2858	1858
900 RZR Trail	16-17	N/A	2858	1858
900 RZR XC	15-17	N/A	2858	1858
900 XP Ranger Full Size	13-18	N/A	2856	1854
900 XP Ranger Crew	14-18	N/A	2856	1854
900 XP Ranger Limited Edition	13-14	N/A	2854	-
1000 General	16-18	N/A	2858	1858
1000 RZR XP	14-18	N/A	2858	1858
1000 RZR XP-4	14-18	N/A	2858	1858

MODEL	YEAR	MID-MOUNT	FRONT MOUNT	WINCH MOUNT
1000 RZR S	16-18	N/A	2858	1858
1000 XP Ranger Full Size 4x4	17	N/A	2856	1854
1000 XP Ranger Full Size 4x4	18-19	N/A	2885	1885
1000 XP Ranger Full Size 4x4 Crew	17-18	N/A	2856	1854
Ranger (All CC'S)	05-08	N/A	2850	1850
Ranger XP (All CC'S)	05-08	N/A	2850	1850
Ranger 4X4	01-04	N/A	2849	1849
Ranger 6X6	98-01	N/A	2848	1848
Ranger EV 4X4 Midsize	11-17	N/A	2847	1847
Ranger EV 4X4 Midsize	19	N/A	2857	1857
Ranger Diesel	15-17	N/A	2856	1854
Ranger ETX Midsize 4x4	15-16	N/A	2847	1847
Turbo RZR XP	16-18	N/A	2858	1858
Turbo RZR XP-4	16-18	N/A	2858	1858
<b>SUZUKI</b>				
<b>ATV</b>				
250 Quad Runner	99-02	2525	-	-
280 King Quad	91-98	2525	-	-
300 King Quad	93-98	2525	-	-
300 King Quad	99-00	2525	-	1520
300 King Quad	01-02	2525	-	1515
300 King Quad	03	2525	-	-
400 Eiger 2x4, 4x4	02-07	2520	-	-
400 King Quad	08-17	2520	-	1510
450 King Quad	06	-	3930	1530
450 King Quad	07-10	2530	3930	1530
450 King Quad	11-12	-	3930	1530
500 King Quad	09-17	2530	3930	1530
500 LFT Quad Runner	98-02	2520	-	-
500 Vinson	02-06	2520	3910	1505
500 Vinson	07	2010	3910	1505
700 King Quad 4x4	05-07	2530	3930	1530
700 King Quad 4x4	08-16	-	3930	1530
700 Twin Peaks	04-06	2315	-	1335
750 King Quad 4x4	08-17	2530	3930	1530
750 King Quad 4x4	18	2530	-	-

# Mount Guides

MODEL	YEAR	MID-MOUNT	FRONT MOUNT	WINCH MOUNT
<b>UTV; SxS</b>				
QUV	05	N/A	2820	-
<b>TEXTRON (BAD BOY OFF ROAD)</b>				
<b>ATV</b>				
500 Alterra	18	2012	-	-
700 Alterra MudPro	18	2010	3950	-
700 Alterra VLX	18	2010	3950	FIM
<b>UTV; SxS</b>				
Bad Boy Ambush 4X4	13-14	N/A	2873	-
Bad Boy Classic 4X4	06-10	N/A	2875	-
Bad Boy Instinct 4X4	13-14	N/A	2873	-
Bad Boy Recoil 4X4	13-14	N/A	2873	-
Bad Boy XT 4X4	10-11	N/A	2874	-
Bad Boy 900 Stampede	16	N/A	2877	FIM
Textron Off Road 900 Stampede	17	N/A	2877	FIM
Textron Off Road Stampede XTR 900	17	N/A	2877	FIM
Wildcat Trail (XT) (LTD)	18	N/A	2866	FIM
Stampede	18	N/A	2877	FIM
Stampede X	18	N/A	2877	FIM
Stampede 4	18	N/A	2877	FIM
Stampede 4X	18	N/A	2877	FIM
Havoc X	18	N/A	2877	FIM
<b>YAMAHA</b>				
<b>ATV</b>				
250 Bruin	05-06	2620	-	-
350 Bruin 2x4, 4x4	04-06	2615	-	1615
350 Grizzly 2x4, 4x4	07-09	2615	3916	1615
350 Grizzly 2x4, 4x4	10-12	2615	3916	-
350 Grizzly 2x4, 4x4	13-14	2615	-	1615
350 Wolverine	95-05	2620	-	1655
400 Big Bear 2x4 4x4	97-06	2620	-	1650
400 Big Bear 2x4 4x4	07-11	2620	-	1640
400i Big Bear	07-09	2640	-	1640
400 Grizzly	05-07	-	3916	1615
400 Kodiak	94-98	2630	-	-
400 Kodiak	99	2620	-	-
400 Kodiak	00-02	2615	-	1620

MODEL	YEAR	MID-MOUNT	FRONT MOUNT	WINCH MOUNT
400 Kodiak	03-07	2615	3916	1615
450 Grizzly	03-06	-	3916	1615
450 Grizzly	07-12	2615	3916	1615
450 Grizzly	13-14	2615	3916	-
450 Kodiak	03-12	2615	3916	1615
450 Kodiak	13-14	2615	-	-
450 Kodiak (SE)	18	2616	3921	FIM
450 Wolverine	06-08	2615	-	1660
450 Wolverine	09	2615	-	-
550 Grizzly 4x4	07-08	-	3915	1625
550 Grizzly 4x4	09-12	2615	3915	1625
550 Grizzly 4x4	13-14	2610	3915	1625
600 Grizzly 4x4	98-01	2625	-	1610
660 Grizzly 4x4	02-08	2615	3914	1605
700 Grizzly 4x4	07-12	2615	3915	1625
700 Grizzly 4x4	13-14	2610	3915	1625
700 Grizzly 4x4	15	2610	-	1625
700 Grizzly 4x4	16	2610	3918	1618
Grizzly LE/SE 4x4	17-18	2610	3920	1618
700 Kodiak 4x4	16	2610	3918	1618
700 Kodiak 4x4 (SE)	17-18	2610	3920	1618
<b>UTV; SxS</b>				
450 Rhino	06-11	N/A	2835	1635
660 Rhino	04-08	N/A	2835	1635
700 Rhino	06-13	N/A	2835	1635
Viking	14-18	N/A	2836	1836
Viking	19	N/A	2836	-
Viking VI	15-18	N/A	2836	1836
Wolverine	16-17	N/A	2837	1637
Wolverine	18	N/A	2837-REV A	-
Wolverine R-Spec (SE)	16-17	N/A	2837	1637



# 2805 Push Tube and "V" Blade Replacement Parts

- 1 - Rubber Flap with Hardware\*
- 2 - Right Side Wear Bar\*
- 3 - Left Side Wear Bar\*
- 4 - Right Side Blade\*
- 5 - Left Side Blade\*
- 6 - Pivot Pin
- 7 - Nose Piece
- 8 - Support Arm
- 9 - Support Arm Pin
- 10 - Spring and Eye Bolt
- 11 - Blade Swivel
- 12 - Blade Stops
- 13 - Skid with Hardware\*
- 14 - Blade Position Pin Assembly
- 15 - Push Tube
- 16 - Mounting Pin with Clip

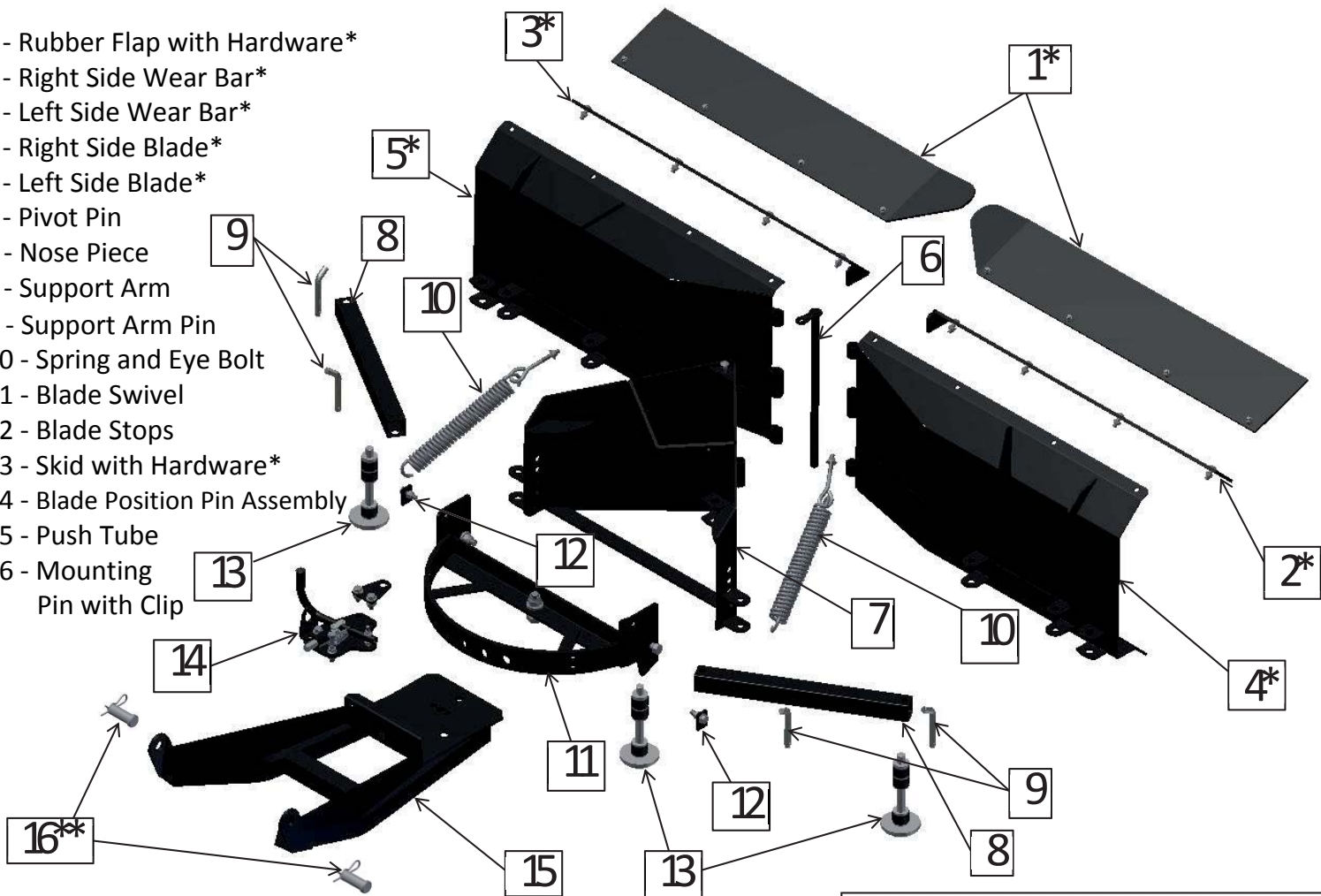

\*\*Mounting Pins with Clips are packaged with UTV Plow Mounts. They are show here as replacements.

\*See 2805 Push Tube and Blade Replacement Parts List, for available sizes and options.



## 2906 Push Tube and Blade Replacement Parts

- 1 - Rubber Flap with Hardware
- 2 - Wear Bar with Hardware
- 3 - Skid with Hardware
- 4 - Blade
- 5 - Spring and Eye Bolt
- 6 - Blade Swivel
- 7 - Blade Stops
- 8 - Blade Position Pin Assembly
- 9 - Quick Latch with Hardware
- 10 - Push Tube

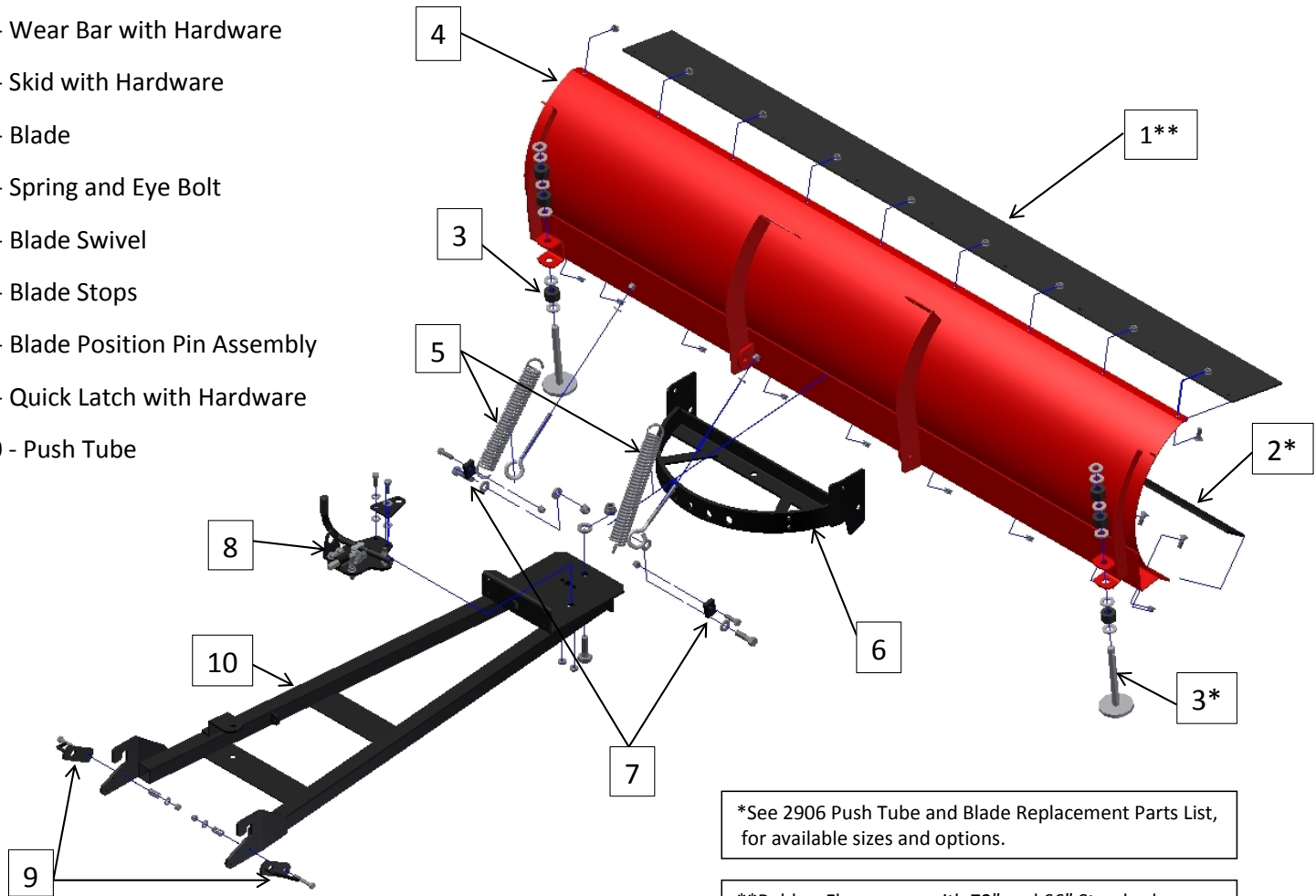

\*See 2906 Push Tube and Blade Replacement Parts List, for available sizes and options.

\*\*Rubber Flaps come with 72" and 66" Standard Blades, as well as the 60" and 50" Country Blade. Smaller Rubber Flaps are available for smaller Blades.

# 3906 Push Tube and Blade Exploded View

Two 3/8" X 6" Eye Bolt  
Two 3/8" Washers  
Two 3/8" Nylock Nuts

Two 3/8" X 1" Bolts  
Four 3/8" Washers  
Two 3/8" Wiz Nuts

Two 1/4" X 2" Bolts  
Two Springs  
Two 1/4" Washers  
Two 1/4" Nylock Nuts

5/8" X 2" Bolt  
5/8" Washer  
5/8" Nylock Nut

Two 3/8" X 1 1/4" Bolts  
Two Blade Stops  
Two Nylock Nuts

Two 1/2" X 1 3/4" Bolts  
Four 1/2" Washers  
Two 1/2" Nylock Nuts

5/16" Carriage Bolts  
5/16" Wiz Nuts