



Can-Am 1000 Outlander

NOTE: This kit will fit the Renegade 1000, but the Logo Plate will not attach on the Renegade! There will be an updated kit soon!

Lift Kit Installation Instructions

Read Before Installation

This product is designed for use on ATVs and/or RUVs to increase ground clearance and fender clearance. It is designed for utility type, slow-speed use on relatively flat terrain in deep mud or snow. Although we have many thousands of satisfied lift kit customers and over 1,800 franchised dealers selling and installing lift kits, purchasers should be aware that use of this product may increase the frequency of required maintenance, part wear, and will raise the center of gravity on your ATV and/or RUV, increasing risk of roll-over, injury and death on all types of terrain. It is your responsibility to always inform other operators and passengers of this vehicle about the added risks.

We recommend that wider tires and/or wheel spacers be used to achieve a wider stance and to improve stability of the ATV and/or RUV. Riders should be advised that the handling characteristics of a taller ATV and/or RUV are different and require extra care when riding, particularly on side hills or off-camber situations. If you further raise the center of gravity by adding taller tires, heavy loads to racks or seats, or by any other means, the ATV and/or RUV must be operated with even more care, at slower speeds and on relatively flat ground. All turns should be done at a slow speed, even on level ground.

Operation of an ATV and/or RUV with or without a lift kit, while or shortly after consuming alcohol or drugs, subjects the rider to the risk of serious bodily harm or possible death. This risk is compounded if the rider does not wear an approved helmet and other safety gear. High Lifter urges that all approved safety gear be worn when riding an ATV and/or RUV as a driver or passenger.

Dealers and other Installers

You are responsible for informing your customer and end user of the information contained above and the increased potential hazards of operating an ATV and/or RUV equipped with a lift kit. If you install the lift kit, it is your responsibility to also install the warning label prominently in view of the driver and in prominent view of the driver and passenger on RUVs and multi-passenger ATVs. They should also be instructed to notify anyone operating the vehicle, as well as any passengers, that a lift kit is installed.

As discussed above, it is critically important that they be instructed in the need for slower speed operation, regardless of terrain, after this lift kit is installed.

Parts Diagram

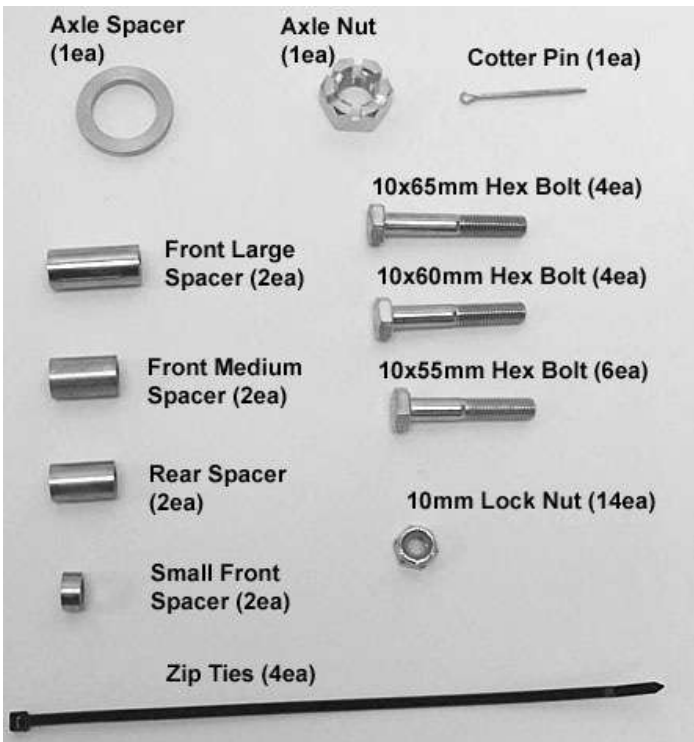
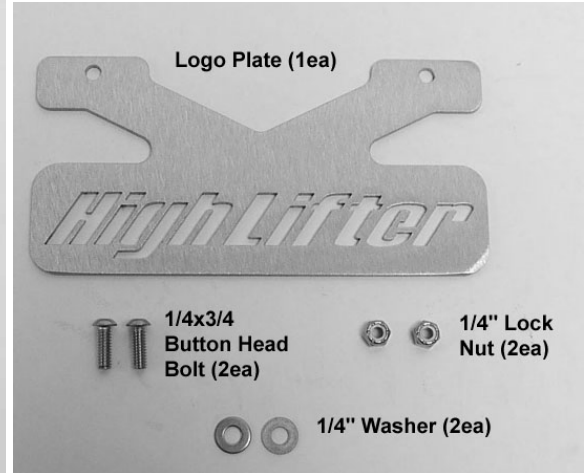
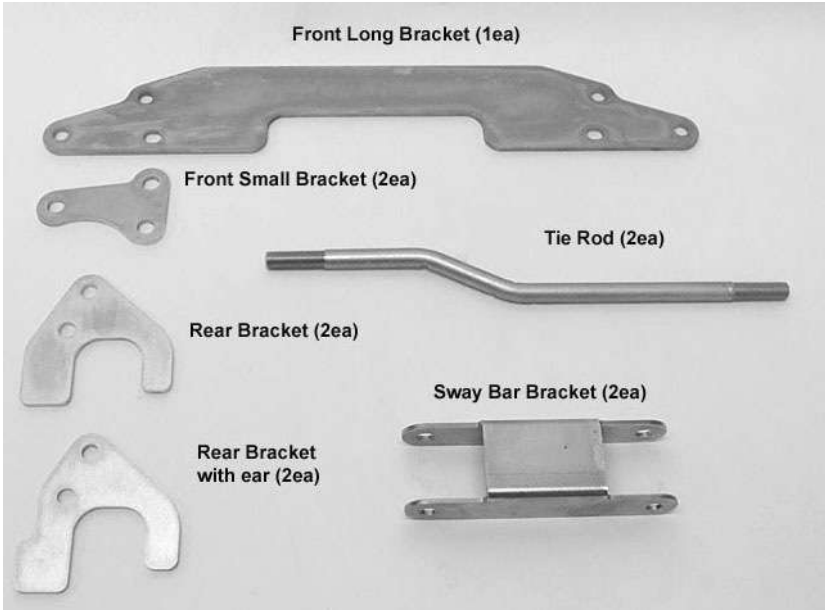

Note: Left and Right positions are from the seated position on the ATV.
NOTE: The logo bracket me look different from picture

Front Lift Installation

- 1) Place ATV transmission in park. Place jack under center of ATV front end and lift until front wheels clear the ground. Be careful to support ATV properly so that it is securely supported so that A-arms and shocks can droop to full extension.
- 2) Remove front wheels.
- 3) Disconnect the top of the shock from the ATV.

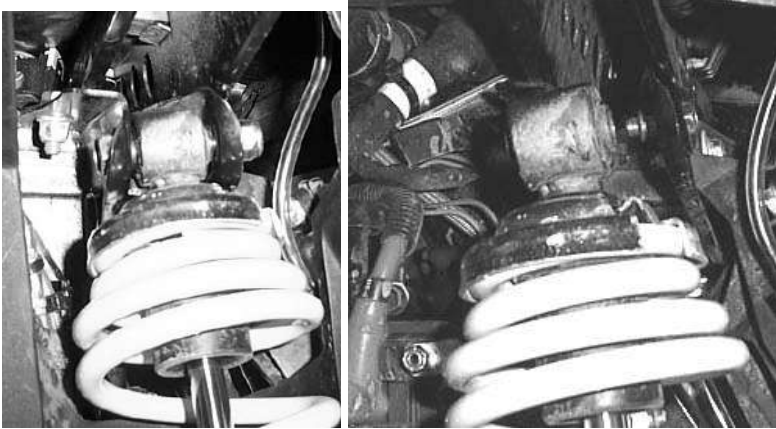

- 4) Remove the inner fenders from both sides of the ATV.

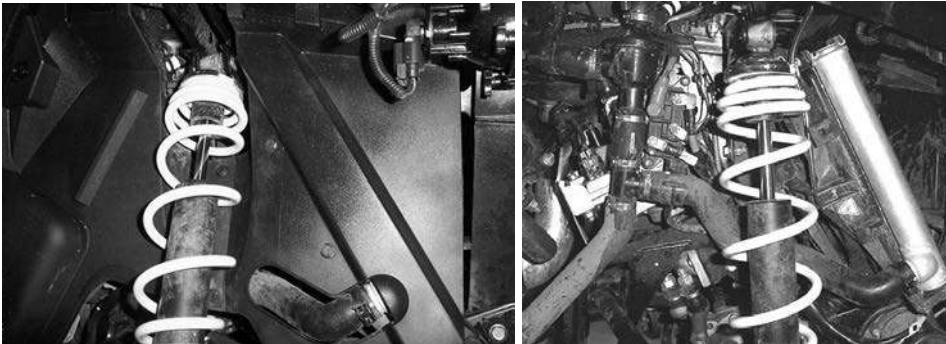

- 5) Insert the long front lift bracket in between the shock mounting tabs, but do not connect at this time.

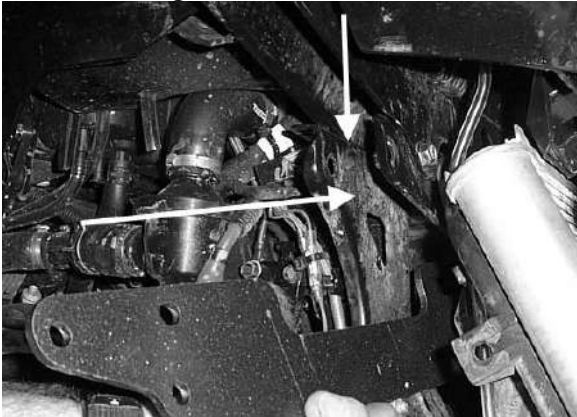

- 6) You will need to relocate the vent tube that is connected the front differential. It will interfere with the bracket and how it mounts. The vent tube is located on the left side of the ATV.

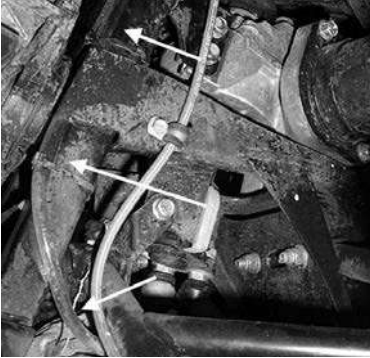

- 7) Disconnect it from the differential, cut the zip ties holding it in place, and pull it up through the hole near where the shock mounts to the frame.

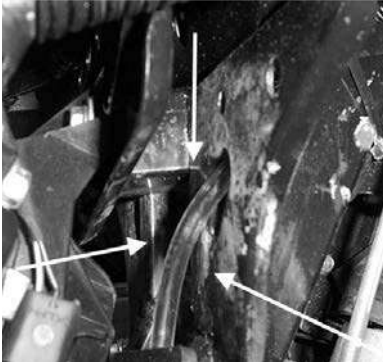

- 8) Relocate it to the back side of the frame opposite from where it was running and reconnect it to the differential and secure the line with the zip ties provided.

- 9) Once you have relocated the vent tube, connect the long bracket to the frame.

- 10) Using a 10x65mm hex bolt and the front medium spacer connect the bracket to the frame.



11) Place the front small spacer on the outside of the shock mount on the end of the bolt.

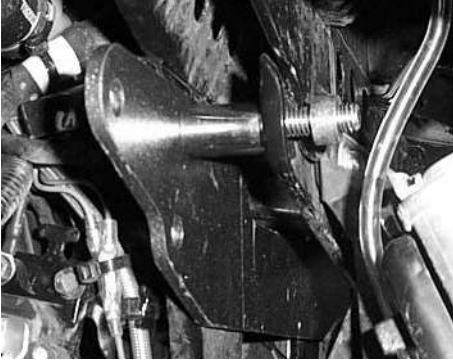

12) Insert a 10x65mm hex bolt into the lift bracket, then place the front large spacer on the bolt then place the small front lift bracket on both bolts to the outside of the shock mount tabs.

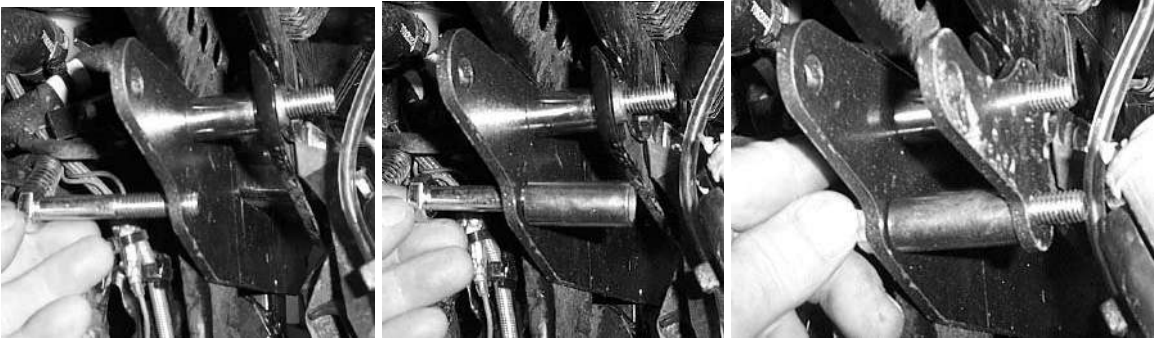

13) Loosely connect the brackets with the 10mm lock nut.

14) Before you connect the top of the shock to the brackets place the inner fenders in place but do not connect them.



15) Now, connect the top of the shock to the brackets using a 10x55 hex bolt and 10mm lock nut.

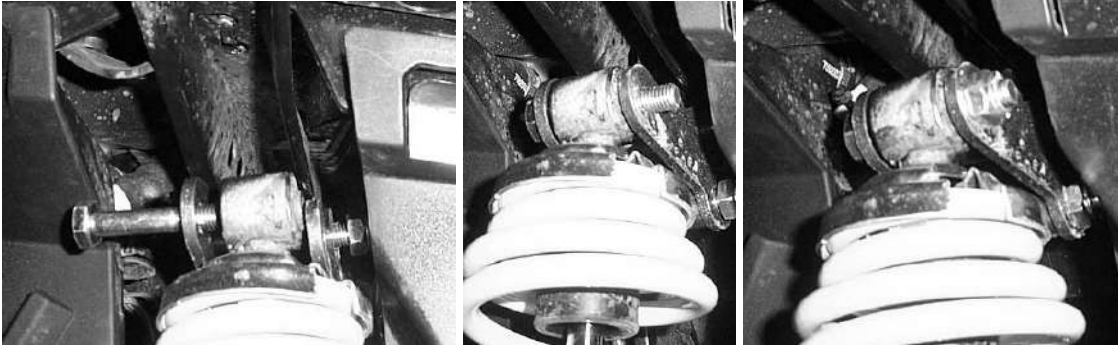

- 16) Tighten all bolts, and then you can replace the inner fender.
- 17) Next you will replace the stock tie rods with the new angled rods provided.
- 18) Disconnect the rod and joint from the knuckle assembly.

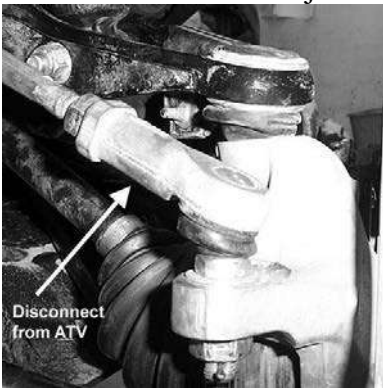

- 19) Remove just the rod and jam nut from the steering stem.



- 20) Here is the new rod and a photo representation of short and long ends.

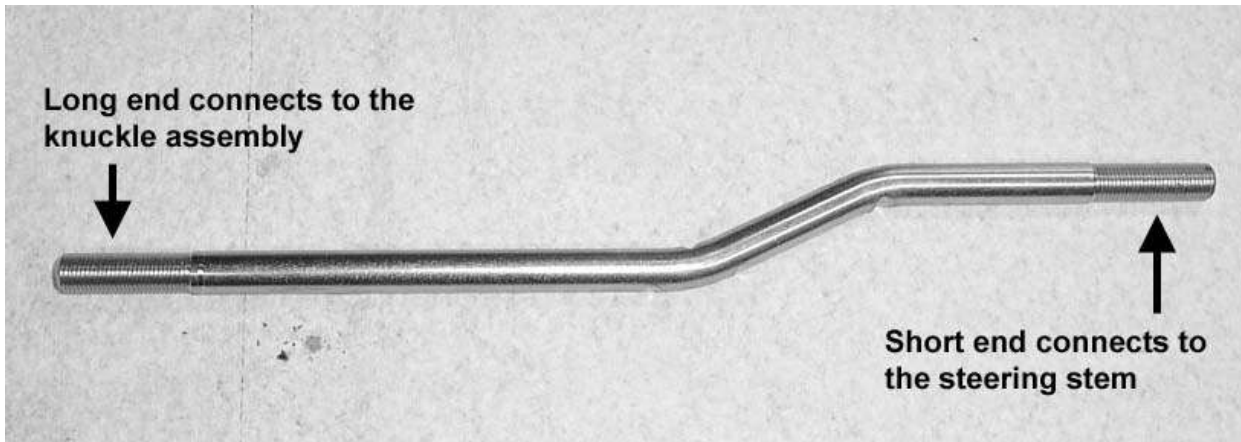

21) Place the jam nut that was connected to the steering stem to the short end of the new tie rod.

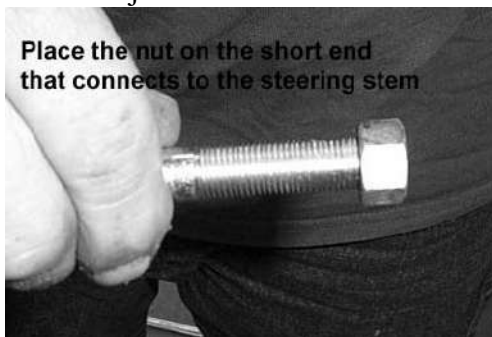

22) Now connect the joint and jam nut that was connect to the knuckle assembly to the longest end of the new tie rod.

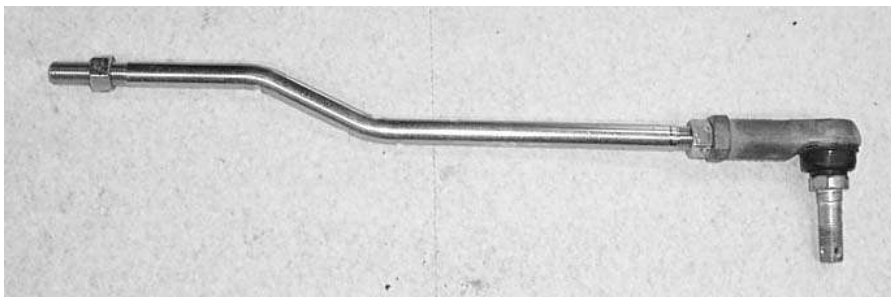

23) Connect the new tie rod to the ATV.



24) Make sure to reuse the washers, castle nut, and cotter pin to connect the end to the knuckle assembly but do not insert the cotter pin until you have checked the tow on the ATV so assemble both sides.



25) Read the following steps on how to adjust toe:

Aligning the front wheels

1. Make sure that the brake rotors are straight to sight.
2. Take a tape measure and measure from inside to inside on the front and back ends of the rotors.
3. They must both be the same distance. If they do not then you will need to adjust the tie rods in or out.

NOTE: A slight toe out makes the steering less sensitive and the ATV more stable. When adjusting the toe, be sure to take the time to adjust both ends half the required distance.

PHOTOS ARE A SAMPLE OF HOW TO DO IT AND MAY NOT REPRESENT YOUR ATV IN THE PHOTOS

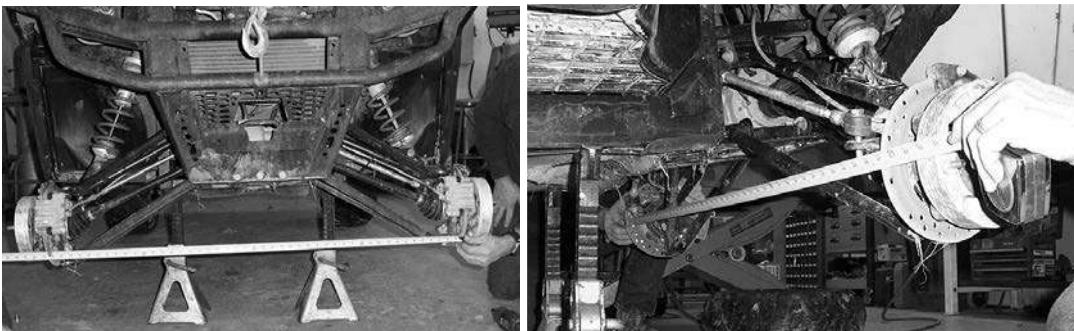

26) Once you have set the tow on your ATV then torque the castle nuts and insert the cotter pin.

27) When you have completed the installation place the wheels back on the ATV and torque lugs to factory specifications. Lower and remove jack.

Rear Lift

- 1) Place jack under the center of the ATV and lift until the weight is off the suspension. Be careful to secure the ATV properly so it is stable on the jack.
- 2) Remove the rear wheels.
- 3) Disconnect the bottom of the shock and the brackets that connect the sway bar bracket to the sway bar and arms. **Disconnect both sides!**

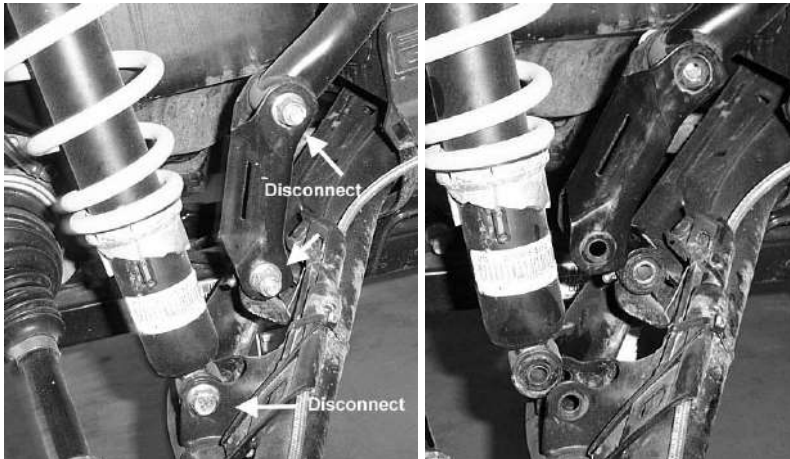

- 4) When the rear arms are at full extension they will be resting on a plate that is connected to the frame. You will need to mark this area where it is touching and trim later. You will need to trim both sides.



5) Remove the castle nut and hub from the ATV.

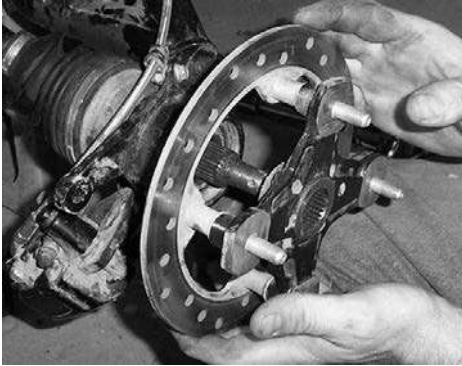

6) Disconnect the pivot rod. You only need to remove the nut from one side on the pivot rod. You can pull it out from the opposite side that has the nut still attached.

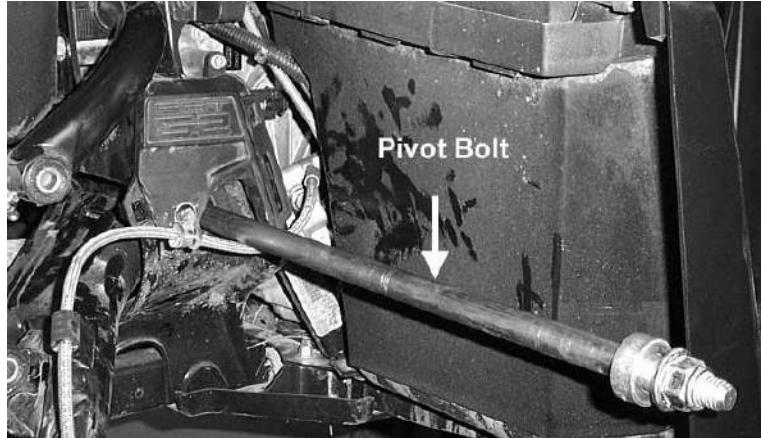
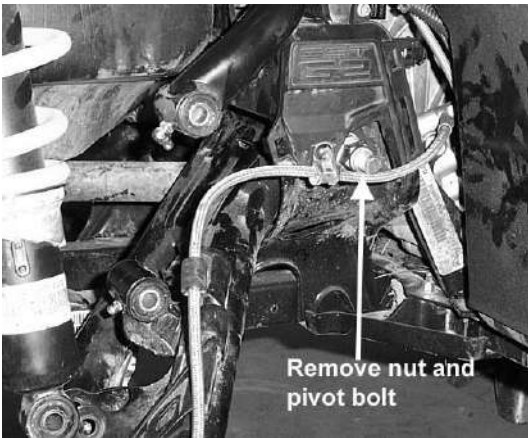

7) Once you remove the pivot rod the rear arms will be free from the ATV. Remove them then trim the marked area on the plate.



- 8) **ONLY ON THE REAR RIGHT:** Insert the new axle spacer on the axle and place the hub back on the ATV. Then fasten with the new castle nut provided in the kit. Do both sides at this point.

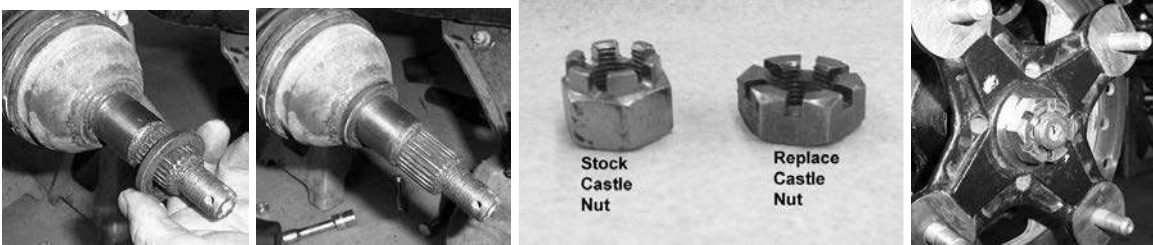

- 9) Reattach the arms and pivot rod to the ATV.

- 10) Connect the new sway bar brackets to the sway bar and rear arms. Use two 10x60 hex bolts and 10mm lock nuts to secure the bracket.

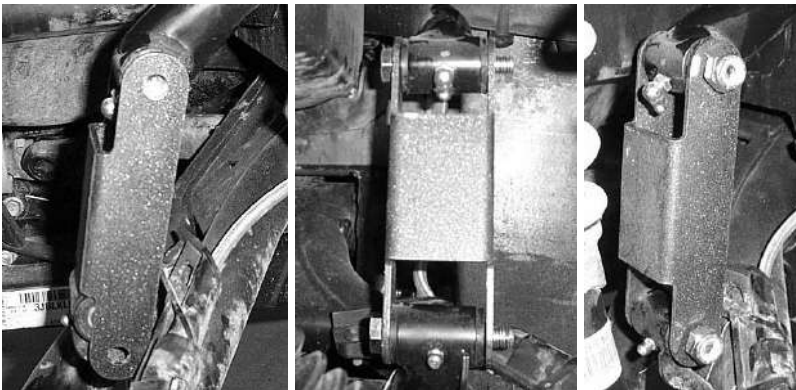

- 11) Insert the rear lift bracket that has the ear on it into the shock mount tab.



12) Insert the rear spacer into the shock mount tab next to the bracket, and then insert the 10x55.



13) Connect the bottom of the shock to the lift bracket using a 10x55 hex bolt and 10mm lock nut.



14) Place the other rear lift bracket to the outside of the shock tab and secure it with two 10mm lock nuts.

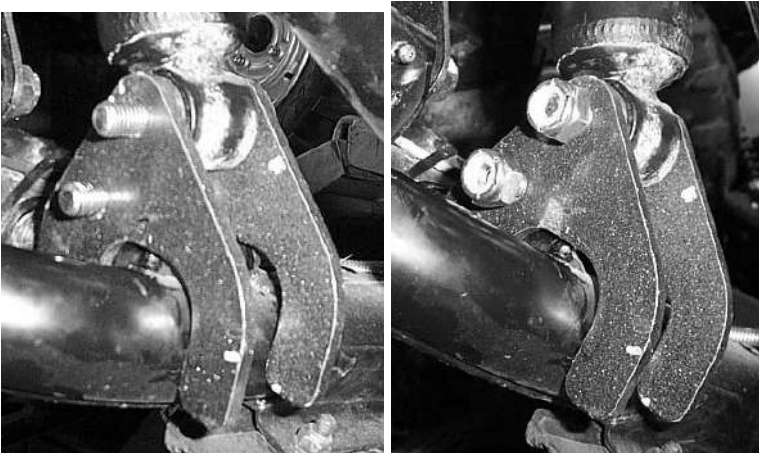

15) Repeat steps for the opposite side.

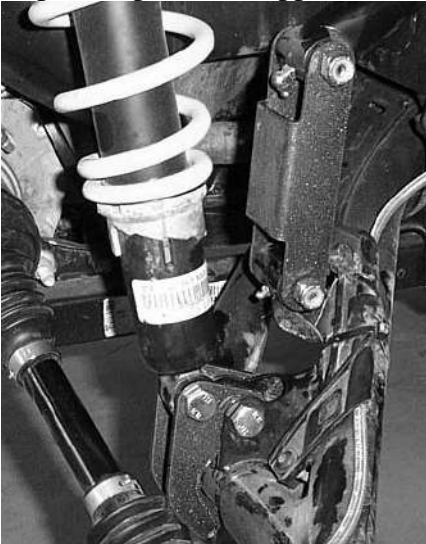

16) Place wheels back on ATV and torque all lugs to factory specifications.

Badge Installation for ATV's equipped with a license plate bracket:

1. Locate the stock mounting bracket.

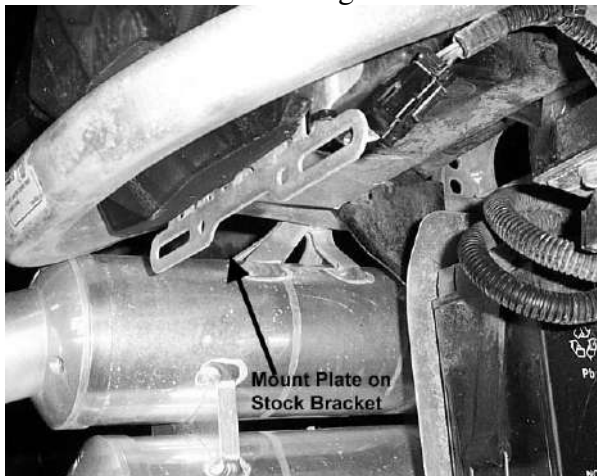

2. Mount the High Lifter Badge to the stock mounting bracket.
3. Use the 1/4" x 3/4" button head bolts, 1/4" washers, and 1/4" lock nuts provided.

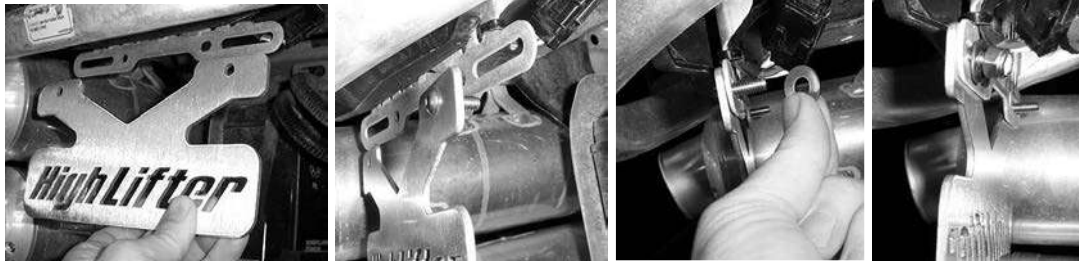

Thank You
For Choosing
High Lifter
PRODUCTS



High Lifter Lifetime Warranty

From the beginning, High Lifter has engineered and manufactured some of the toughest, most durable products on the market. That's why this product comes with a Lifetime Warranty. It's our promise that High Lifter will never let you down.

- The **Lifetime Warranty** covers products sold to the original purchaser only and is not transferable. The term of the warranty is for the lifetime of the vehicle in question.
- Normal wear and tear items and finishes, such as, but not limited to: Heim joints, tie rod ends, ball joints, bearings, seals, bushings, bushing sleeves, zinc plating, powder coating, or chipping and discoloration of any finish is not covered.
- High Lifter will ship the replacement product after the returned product has been inspected by High Lifter staff.
- The warranty shall not include claims for damages, installation time or labor charges, economic losses, inconvenience, transportation, towing, down time, direct or indirect or consequential damages or delay resulting from any defect.
- The warranty does not apply to products that have been improperly applied or improperly installed.

Filename: CLK1000-50 Installation Instructions Without Renegade App
Directory: I:\Instructions\Lift Kit
Template: C:\Documents and Settings\leah\Application
Data\Microsoft\Templates\Normal.dotm
Title: High Lifter Products, Inc
Subject:
Author: Charles Singleton
Keywords:
Comments:
Creation Date: 1/15/2015 12:46:00 PM
Change Number: 5
Last Saved On: 2/20/2015 9:58:00 AM
Last Saved By: Kaci
Total Editing Time: 3 Minutes
Last Printed On: 3/23/2015 2:48:00 PM
As of Last Complete Printing
Number of Pages: 15
Number of Words: 1,565 (approx.)
Number of Characters: 8,926 (approx.)