



## **Can-Am Maverick 2” Lift Kit**

### **Installation Instructions**

#### **Read Before Installation**

**This product is designed for use on ATVs and/or RUVs to increase ground clearance and fender clearance. It is designed for utility type, slow-speed use on relatively flat terrain in deep mud or snow. Although we have many thousands of satisfied lift kit customers and over 1,800 franchised dealers selling and installing lift kits, purchasers should be aware that use of this product may increase the frequency of required maintenance, part wear, and will raise the center of gravity on your ATV and/or RUV, increasing risk of roll-over, injury and death on all types of terrain. It is your responsibility to always inform other operators and passengers of this vehicle about the added risks.**

**We recommend that wider tires and/or wheel spacers be used to achieve a wider stance and to improve stability of the ATV and/or RUV. Riders should be advised that the handling characteristics of a taller ATV and/or RUV are different and require extra care when riding, particularly on side hills or off-camber situations. If you further raise the center of gravity by adding taller tires, heavy loads to racks or seats, or by any other means, the ATV and/or RUV must be operated with even more care, at slower speeds and on relatively flat ground. All turns should be done at a slow speed, even on level ground.**

**Operation of an ATV and/or RUV with or without a lift kit, while or shortly after consuming alcohol or drugs, subjects the rider to the risk of serious bodily harm or possible death. This risk is compounded if the rider does not wear an approved helmet and other safety gear. High Lifter urges that all approved safety gear be worn when riding an ATV and/or RUV as a driver or passenger.**

**If this product is not what you expected, or is not consistent with your intended use, you should return the product immediately to the seller, before installation, for a refund of the purchase price; less any fees. After installation, product is warranted for defects in workmanship and materials. Warranty is limited to refund of the purchase price or replacement of the kit, at the seller’s option.**

#### **Dealers and other Installers**

**You are responsible for informing your customer and end user of the information contained above and the increased potential hazards of operating an ATV and/or RUV equipped with a lift kit. If you install the lift kit, it is your responsibility to also install the warning label prominently in view of the driver and in prominent view of the driver and passenger on RUVs and multi-passenger ATVs. They should also be instructed to notify anyone operating the vehicle, as well as any passengers, that a lift kit is installed.**

**As discussed above, it is critically important that they be instructed in the need for slower speed operation, regardless of terrain, after this lift kit is installed.**

# Parts Diagram

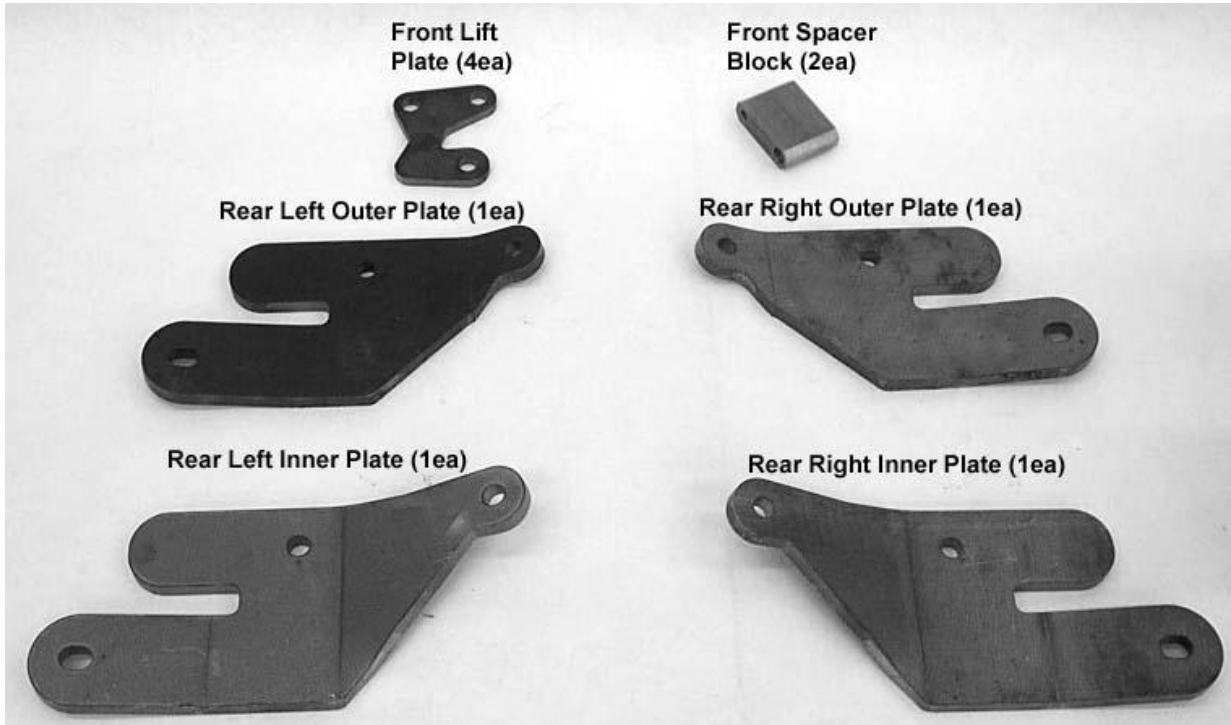

**Note: Left and Right positions are from the seated position on the ATV.**

## Front Lift Installation

- 1) Place transmission in park. Place jack under center of front end and lift until front wheels clear the ground. Be careful to support properly so that it is securely supported so that A-arms and shocks can droop to full extension.
- 2) Remove front wheels.
- 3) Disconnect the top of shock from the frame.

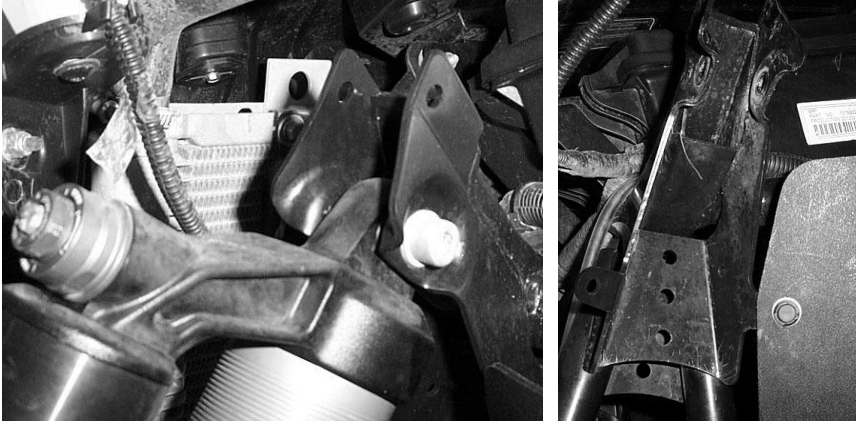

- 4) Insert the spacer block into the shock mount with the small hole end going in first.



- 5) Attach the spacer block to the frame by inserting the 1/4" x 2 1/4" hex bolt through existing holes in the frame and block. Fasten it loosely with a 1/4" lock nut, so that you can pivot the block to align holes to the lift bracket.

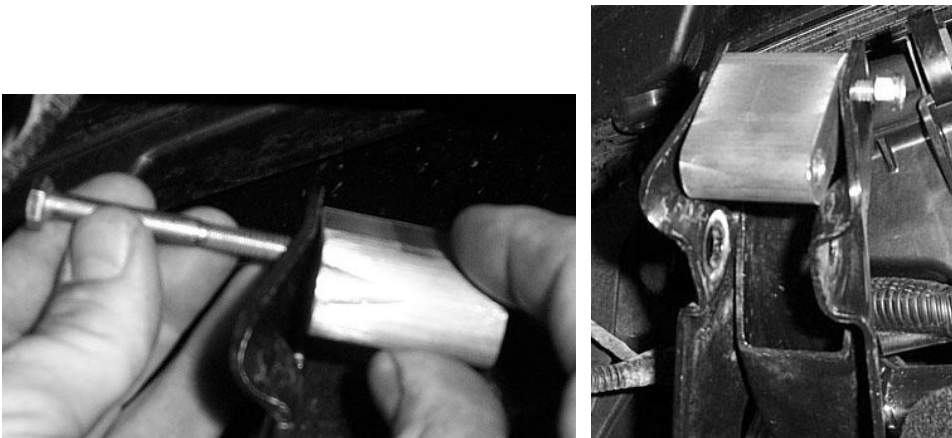

- 6) Next connect the front lift plates to the frame. Slide it into place by aligning holes on the shock mount and the holes on the lower part of the bracket with existing holes in the frame.



- 7) Pivot the spacer block up to align it with the holes in the lift bracket. Insert a 10x70mm bolt through the bracket and block.

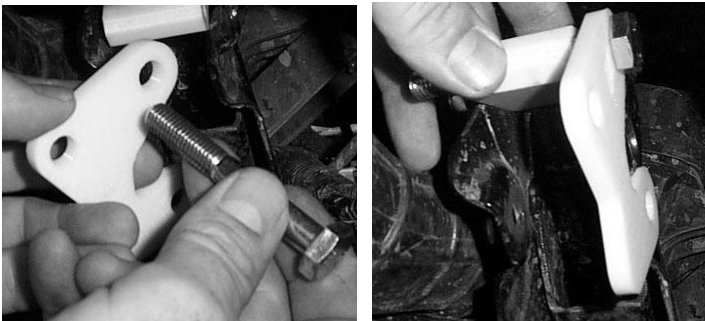

- 8) Next insert the large spacer into the stock shock eyelet location and connect it by inserting a 12x70mm hex bolt through the bracket and spacer.



- 9) Place another front lift plate on the bolts and fasten by placing 10mm & 12mm lock nuts on the bolts. Also make sure to securely fasten the 1/4" lock nut on the 1/4" bolt.

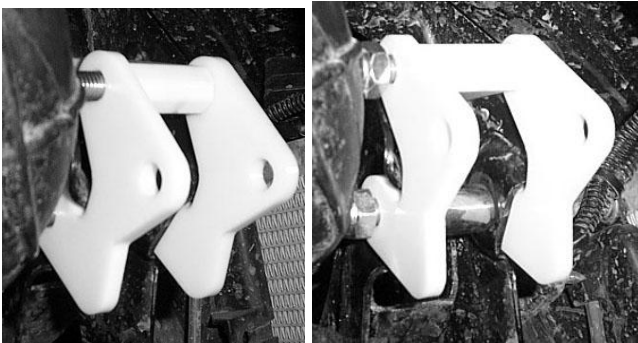

10) Insert a 12 x70mm bolt through the bracket and place the Small spacer on the bolt. Insert the shock eyelet between the spacer/bolt and the bracket. Once the shock is in place, push the bolt through and fasten with a 10mm lock nut.

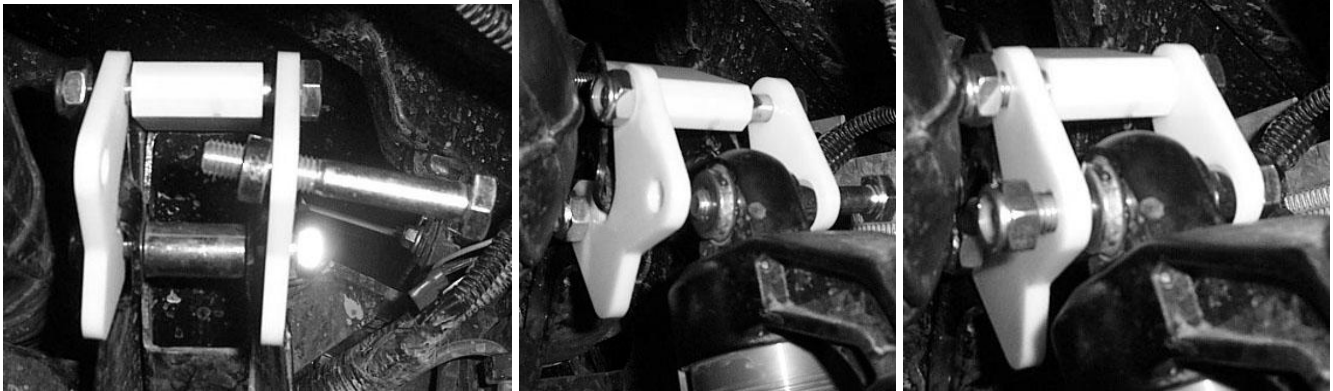

11) Repeat steps for opposite side.

12) When you have completed the installation place the wheels back on the UTV and torque lugs to factory specifications. Lower and remove jack.

## Rear Installation Sway Bar Bracket and Lift Brackets

- 1) Place jack under the center of rear and lift until the weight is off the suspension. Be careful to secure the properly so it is stable on the jack.
- 2) Remove the rear wheels.
- 3) Disconnect the top of shock from the frame.



- 4) There are four different lift bracket plates for the rear. Two for the left and two for the right. Keep in mind that when we refer to the left and right it is from the seated position. Also when we refer to inner and outer the inner is nearest the frame and outer is to the outside of the body. The outer brackets are smaller than the inner brackets.
- 5) Starting from the left side you will connect the left outer and the left inner bracket to the shock mount. The left brackets when placed on the shock mount will bend to the left or to the outside of the body. See picture for illustration.

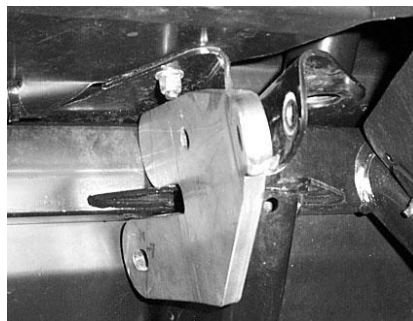
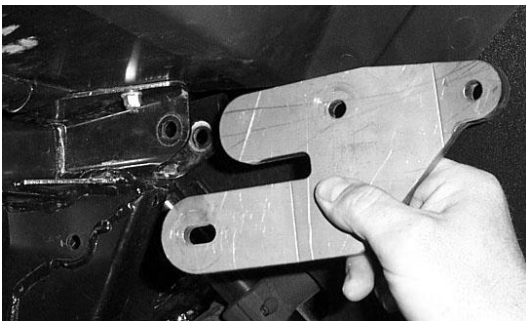

- 6) Insert a 10mm x 95mm hex bolt through the lower slotted hole in the left outer plate and between the plate and frame place the medium spacer. Push the bolt all the way through.



- 7) Next insert a 12mm x 95mm bolt through the plate and shock mount. Insert the large spacer where the shock eyelet was originally and finish pushing the bolt through the spacer. On the other side of the shock mount place the medium spacer on the bolt end.

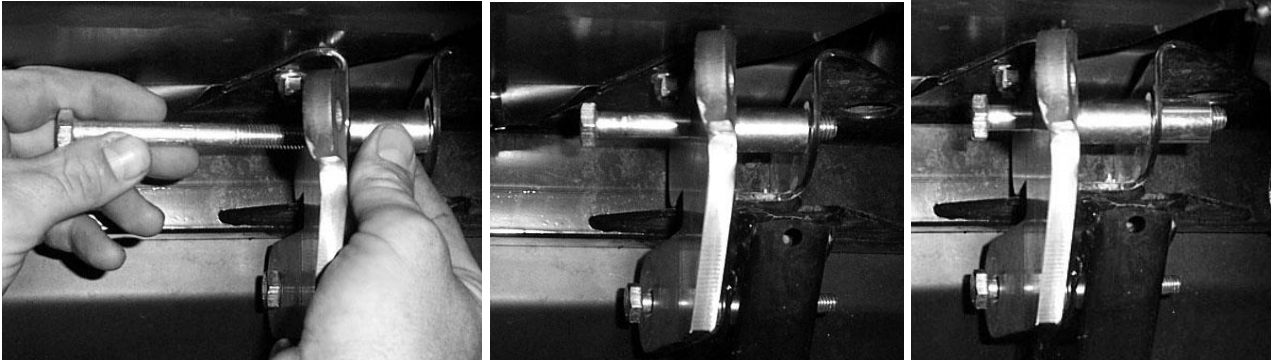

- 8) Place the left inner plate on the bolts and fasten the plates tight with the 10mm & 12mm lock nuts provided.

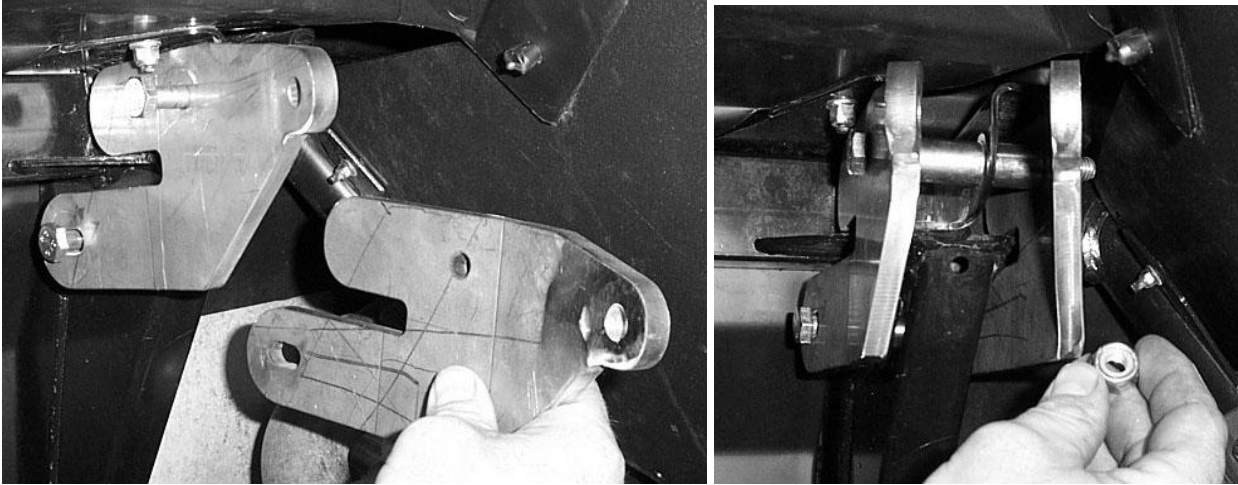

- 9) Insert a 12mm x 70mm hex bolt through the plate placing a flat 12mm washer on the bolt.

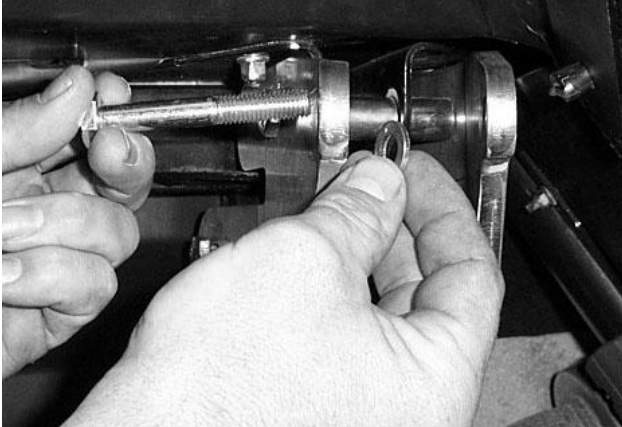

10) Next place the shock eyelet between the plates and insert another 12mm washer between the eyelet and bracket.

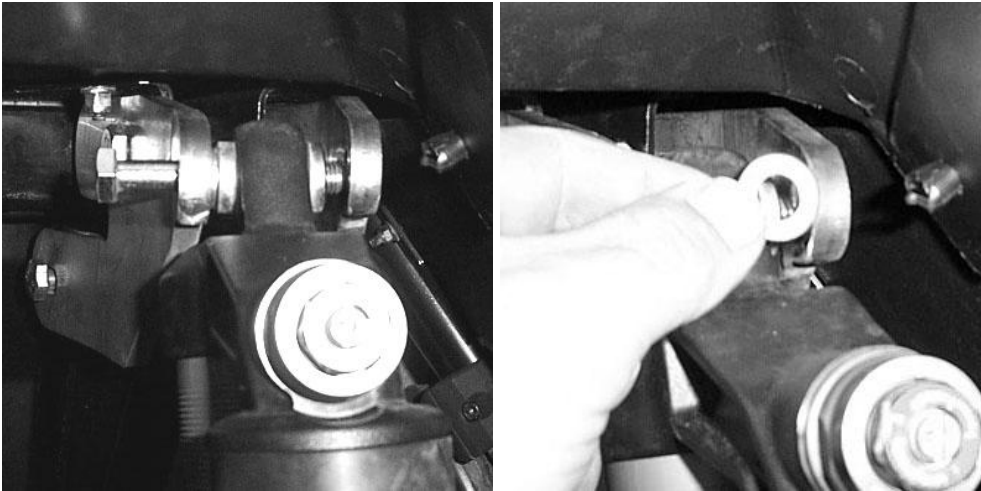

11) Push the bolt all the way through and fasten with the 12mm lock nut provided.

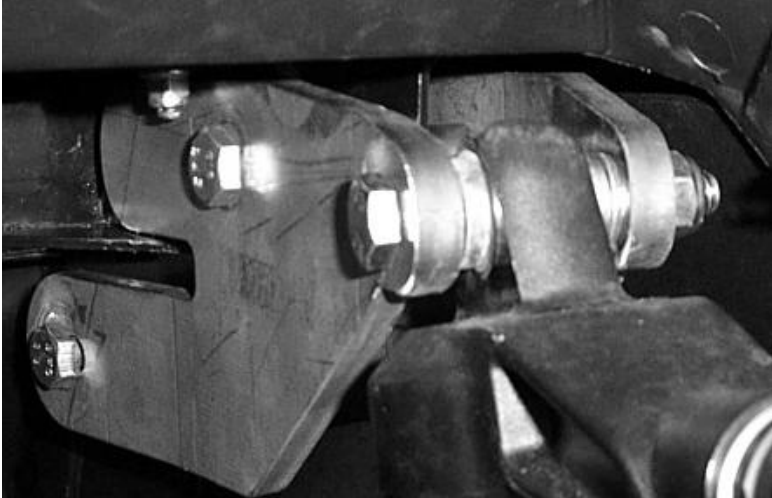

12) Repeat the steps for the right side.

13) Always check for clearance and potential rubbing before you start riding when you have completed the installation.

**Thank You**  
**For Choosing**  
***HighLifter***  
**PRODUCTS**



### **High Lifter Lifetime Warranty**

From the beginning, High Lifter has engineered and manufactured some of the toughest, most durable products on the market. That's why this product comes with a Lifetime Warranty. It's our promise that High Lifter will never let you down.

- The **Lifetime Warranty** covers products sold to the original purchaser only and is not transferable. The term of the warranty is for the lifetime of the vehicle in question.
- Normal wear and tear items and finishes, such as, but not limited to: Heim joints, tie rod ends, ball joints, bearings, seals, bushings, bushing sleeves, zinc plating, powder coating, or chipping and discoloration of any finish is not covered.
- High Lifter will ship the replacement product after the returned product has been inspected by High Lifter staff.
- The warranty shall not include claims for damages, installation time or labor charges, economic losses, inconvenience, transportation, towing, down time, direct or indirect or consequential damages or delay resulting from any defect.
- The warranty does not apply to products that have been improperly applied or improperly installed.

### **Making a warranty claim**

1. All claims must be accompanied by the part and the original sales receipt or other acceptable proof of purchase from the original owner.
2. All warranties must be accompanied with a Return Merchandise Authorization (RMA) number.
3. When shipping the damaged product:
  - a. Write the RMA number on the outside of the box.
  - b. Also include the RMA number, proof of purchase and any notes inside the box.
  - c. Please keep your tracking number and shipment information.
4. The customer is responsible for shipping the product to High Lifter--return shipping within the lower 48 states will be paid by High Lifter products. With all warranty claims, only standard shipping services apply.