



### Polaris RZR® 2014-up\* 900 / 1000

## Subwoofer Enclosure and Speaker Pods

**Note:** This kit comes with 2 amplifier mounting brackets; 14-17, 18+

### Product Features

- Sealed enclosures for improved bass performance
- Provides 10in sub mounting solution
- Molded enclosure replaces original storage box location
- Stainless steel hardware
- Provides (2) 6.5-6.75 speaker mounting enclosures
- HDPE construction
- Black texture coat finish to match Polaris textures
- Amp brackets for 14-17 and 18+

### TABLE OF CONTENTS

|                                |       |
|--------------------------------|-------|
| Disassembly.....               | 2-5   |
| MPS-RZSB Install.....          | 6-7   |
| 14-17 Amp bracket install..... | 8     |
| 18+ Amp bracket install.....   | 9     |
| MPS-RZSP Install.....          | 10-11 |
| Specifications.....            | 12    |

### TOOLS & INSTALLATION ACCESSORIES REQUIRED

- T-40 star driver
- Pry tool
- Silicone sealer
- Metric and Standard socket set
- Open-ended 14mm
- 5/16 bit
- Pry tool
- Helper

### Part Components

A) Sub Enclosure (MPS-RZSB)



B) Amp Bracket 14-17, 18+

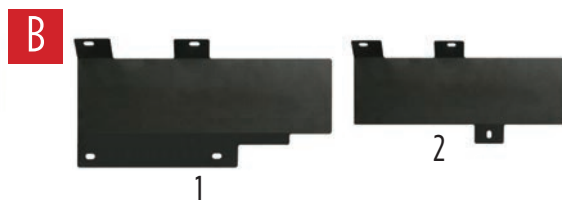

C) Speaker Pods (MPS-RZSP, L & R) D) Mounting Hardware



**Attention!** We recommend removing the main battery fuse prior to installation. When testing the after-market equipment, ensure that all factory equipment is connected before cycling the key to ignition.

## DISASSEMBLY 15-17 900/1000

### Hood Removal (w/ or w/out Ride Command®)

1. Turn both latches 1/4 turn to unlock the rear portion of the hood.
2. Lift the rear of the hood and slide forward to disengage the front tabs.  
(Figure A)

### Dash Removal

1. Un-clip locking pin then slide out passenger T handle.
2. Remove (2) T-40 Torx screws located between front fenders on the upper dash cover.  
(Figure B)
3. Disconnect the instrument cluster, AWD switch, headlight switch, and ignition switch.  
**Notate their location and wire routing**, then remove the upper dash.  
(Figure C, page 3)
4. If equipped, back out the blue LED light from the lower dash.
5. If equipped, remove (1) T-40 Torx head screw from the dash pocket brace, then the plastic dash pocket can be pulled out of the dash. (USB cable as well on Ride command models.)  
(Figure D, page 3)
6. Remove the (2) T-40 Torx screws retaining the lower dash. The lower dash is also attached by clips.  
(Figure E, page 3)
7. Remove the dash assembly from the vehicle, pull the dash straight out to remove.

### Storage Box

1. Remove the (2) 10 mm bolts.  
(Figure F, page 3)
2. Remove the storage box from the vehicle, pull down and out to release from the mounting tabs.  
**The storage box will no longer be needed.**

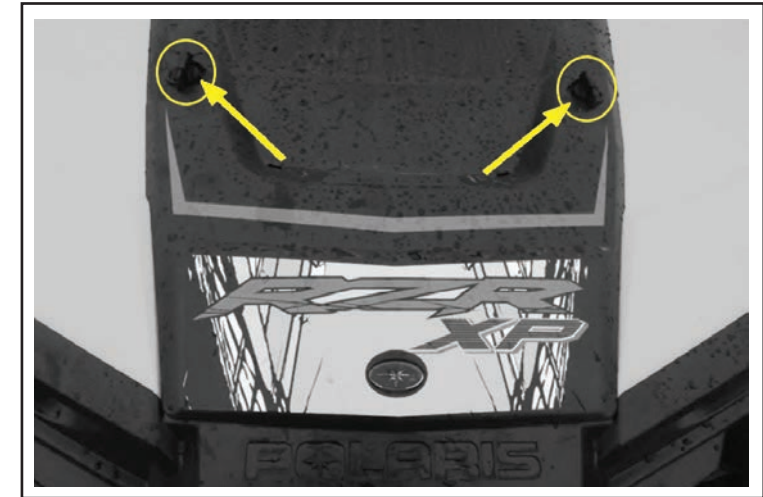

(Figure A)

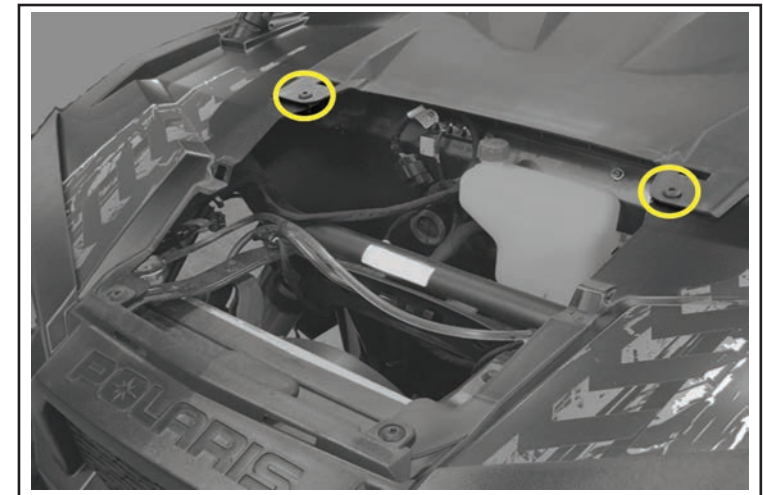

(Figure B)

*Continued on next page*

## DISASSEMBLY 15-17 900/1000

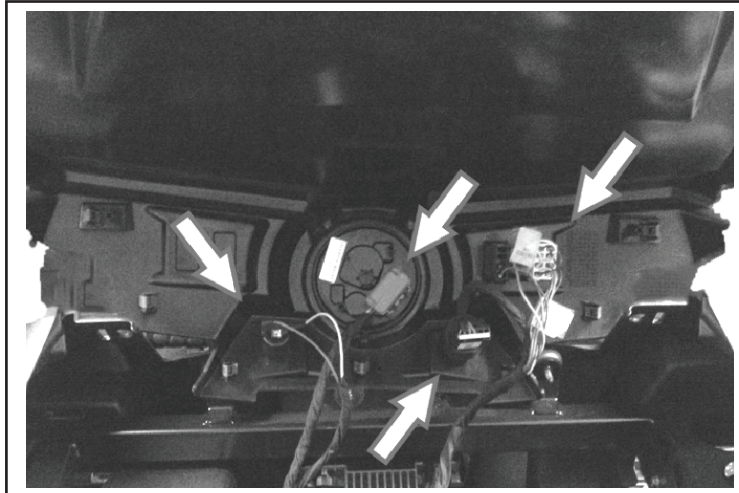

(Figure C)

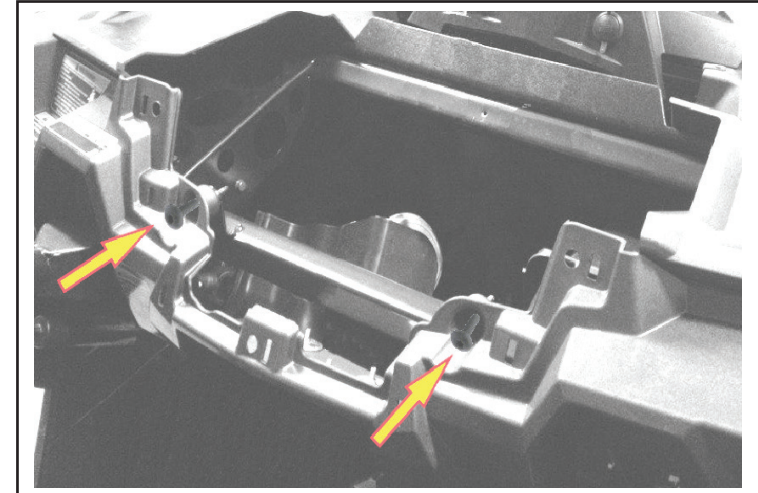

(Figure E)

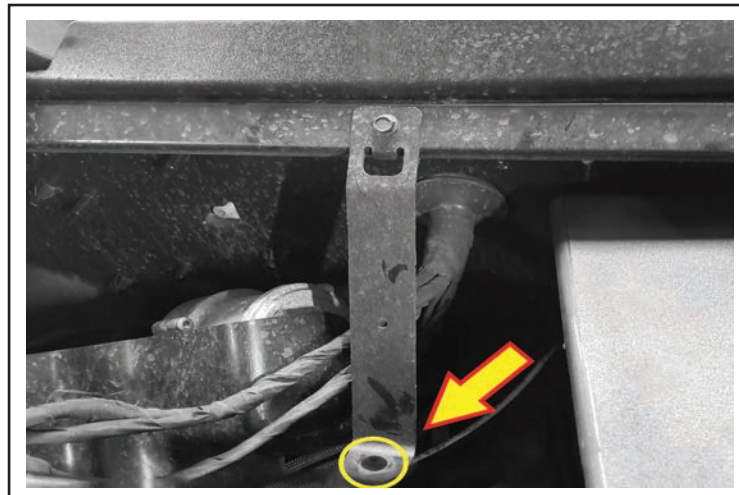

(Figure D)

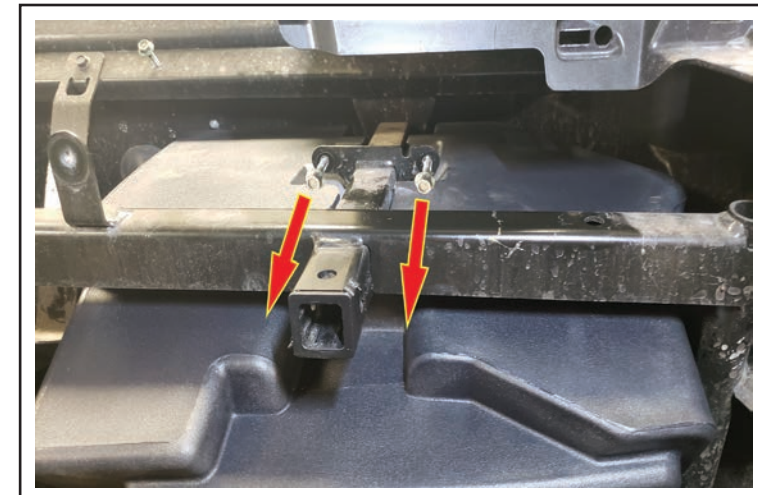

(Figure F)



# DISASSEMBLY 18+ 900/1000

## Hood Removal

1. Turn both latches 1/4 turn to disengage the rear portion of the hood.
2. Lift the rear of the hood and slide forward to disengage the front tabs.  
(Figure A)

## Dash Removal

1. Un-clip locking pin then slide out passenger T handle.
2. Remove (4) T-40 Torx screws located between front fenders on the upper dash cover.  
(Figure B.1)
3. Depending on vehicle model, remove (2) push pins retaining display bezel / storage bezel.  
(Figure B.2)
4. Remove the upper dash. (NON Ride Command unit shown).  
(Figure C, page 5)
5. For Ride Command models remove (4) T-40 Torx screws located around display.  
(Figure D, page 5)
6. Remove upper storage box by removing (2) push pins.  
(Figure E, page 5)
7. If equipped, back out the LED light (or USB in Ride command models) from the lower dash pocket.
8. Remove (1) T-40 Torx from the dash pocket brace, then the plastic dash pocket can be pulled out.  
(Figure F, page 5)
9. Disconnect Ignition/switches; note their location for easy re-assembly.
10. Remove the lower dash assembly from the vehicle, pull the dash straight back to remove.

## Storage Box

1. Remove the (2) 10 mm bolts.
2. Remove the storage box from the vehicle, pull down and out to release from the mounting tabs.  
**The storage box will no longer be needed.**

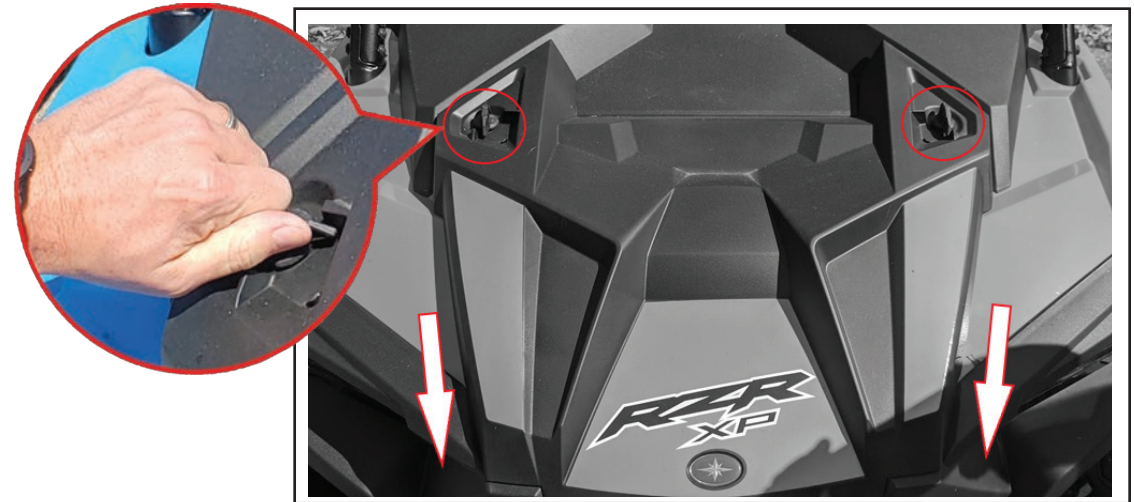

(Figure A)

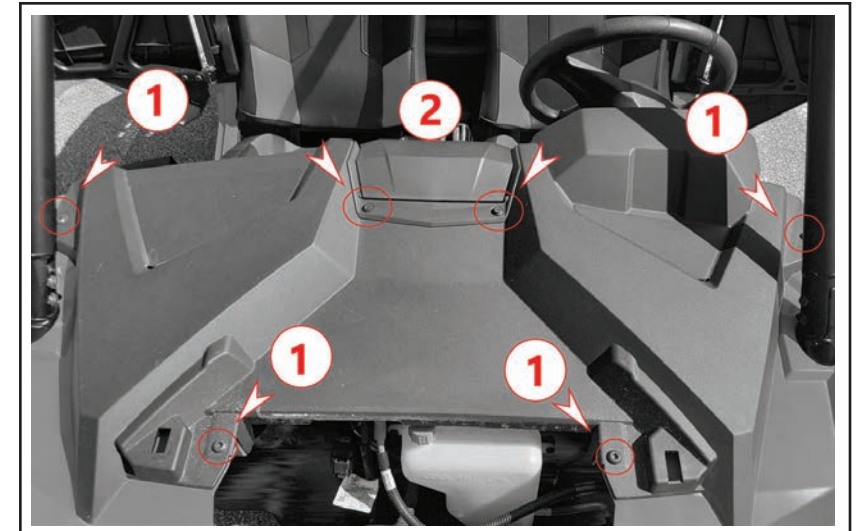

(Figure B)

*Continued on next page*

# DISASSEMBLY 18+ 900/1000



(Figure C)

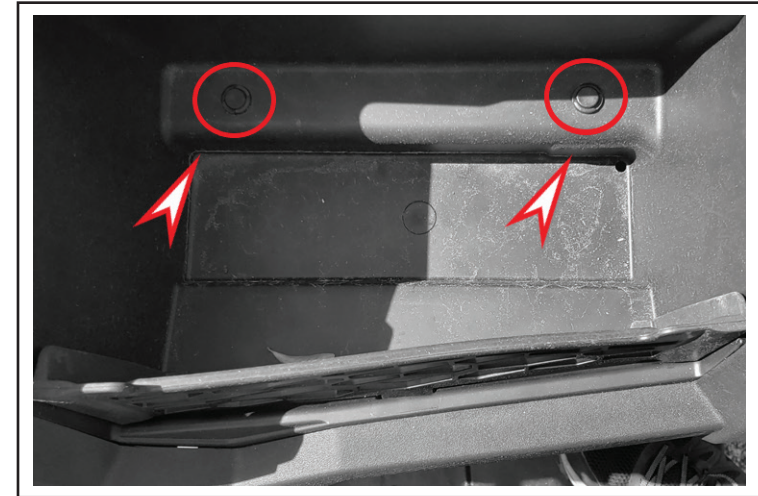

(Figure E)

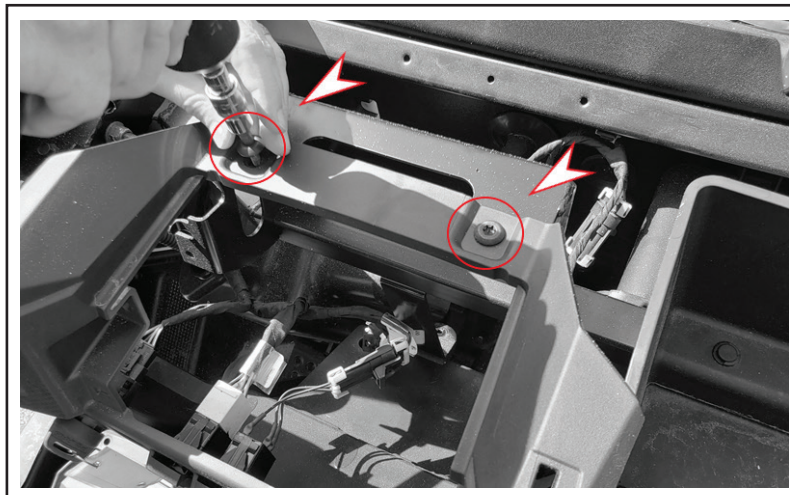

(Figure D)

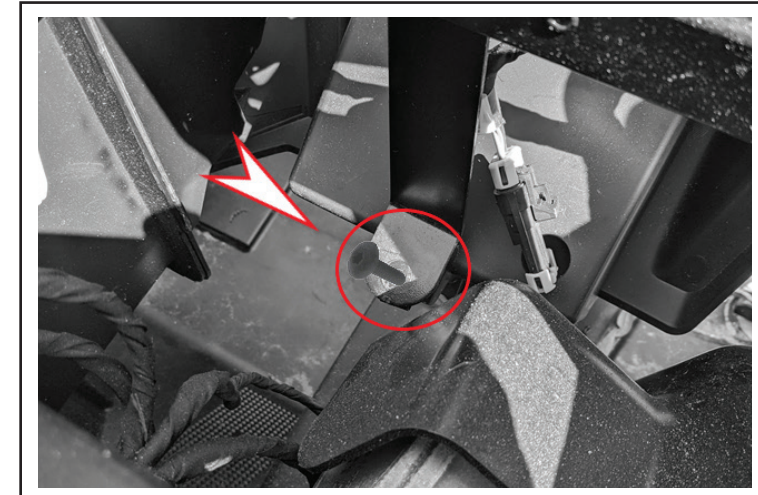

(Figure F)



# INSTALLATION MPS-RZSB

## Subwoofer Enclosure

1. Before mounting the 10 in sub-woofer, Metra Powersports recommends applying a bead of silicone sealant around the sub.  
Metra Powersports also recommends applying a silicone sealant to the speaker wire in the opening to ensure a good weather tight seal.
2. Lift the enclosure into place and align to the OE storage box mount against the square bar channel.  
(Figure A)  
**Note:** 2014-17 Uses all (3) mounting brackets.  
(Figure B.1)
3. While holding the enclosure in place, loosely attached the brackets to the top of the enclosure using the 5/16 head bolts and washers provided.  
(Figure C, page 7)  
**Note:** 2018+ Uses larger (4) hole bracket and the smaller (2) hole U shaped bracket.  
(Figure B.2, page 7)
4. For proper alignment of the sub box, slide the box toward the front of the vehicle.  
(Figure D, page 7)  
**Note:** 2018+ The U shaped front mounting bracket will align the sub box properly  
If not properly placed, the dash panel clips may not align properly.  
(Figure E, page 7)
5. Push against the sub box to keep the enclosure tight against the front wall.  
**Note:** 2018+ Use an open-ended wrench to tighten the front bolts during this step.
6. Tighten the top brackets, as they tighten they may bend slightly, this will help avoid vibrations.  
(Figure F, page 7)

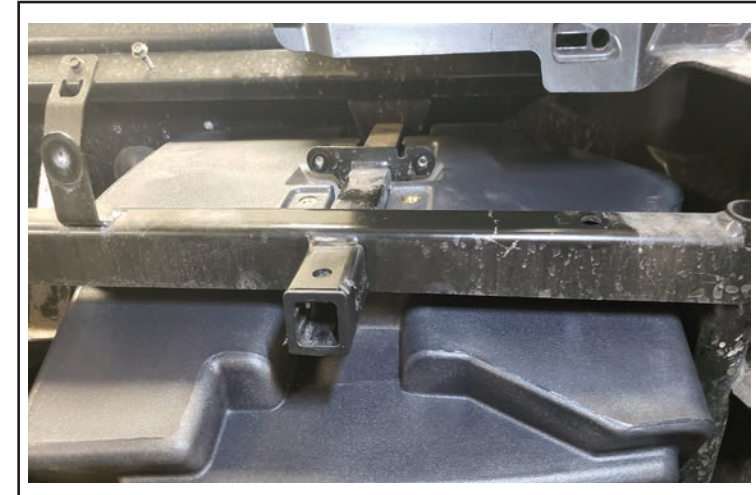

(Figure A)

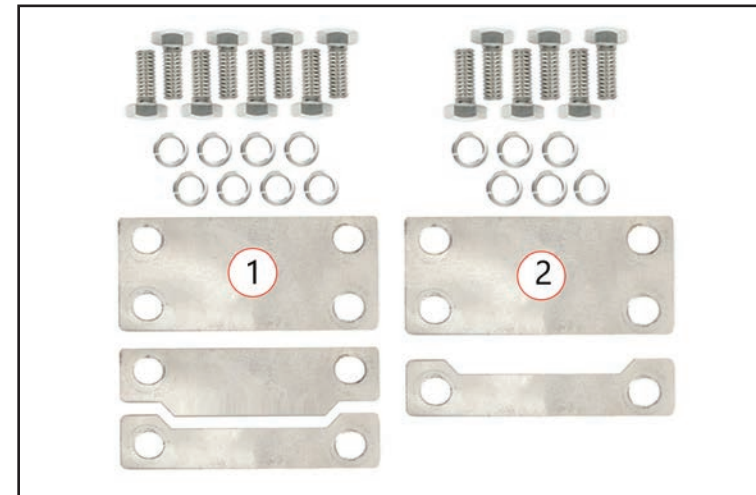

(Figure B)

Continued on next page

# INSTALLATION MPS-RZSB

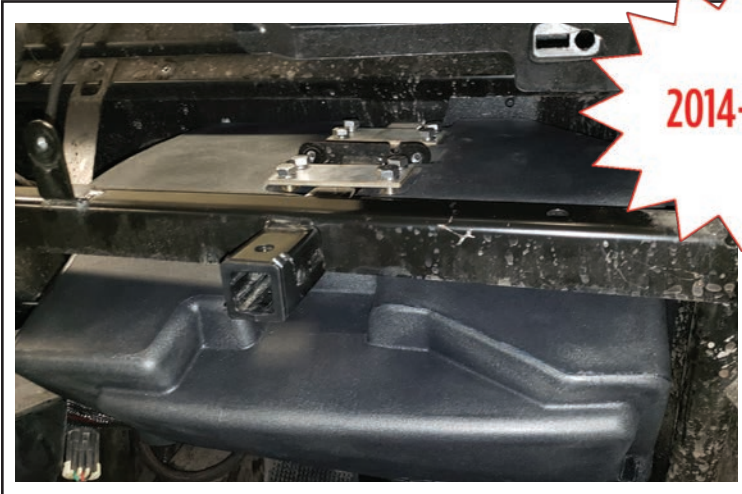

2014-2017

(Figure C)

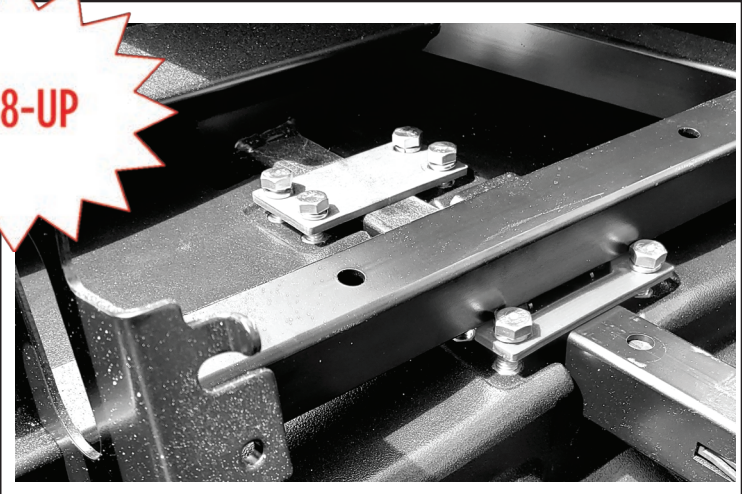

2018-UP

(Figure E)

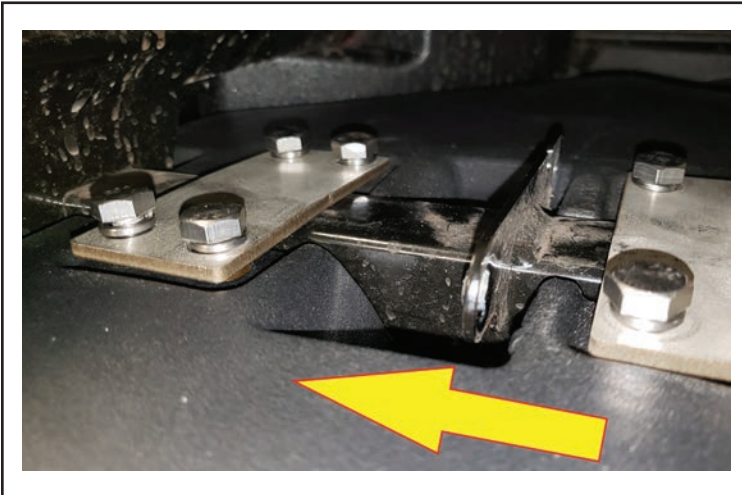

(Figure D)



(Figure F)



## INSTALLATION AMPLIFIER BRACKET 14-17

### Amplifier Bracket

2014-2017

1. The bracket mounts to (4) existing factory points in the middle of the dash above the center pocket bracket.  
(Figure A)
2. Use (4) supplied self threading T-40 Torx bolts.  
(Figure B)
3. mount the amplifier bracket to existing holes in the vehicle.  
(Figure C)

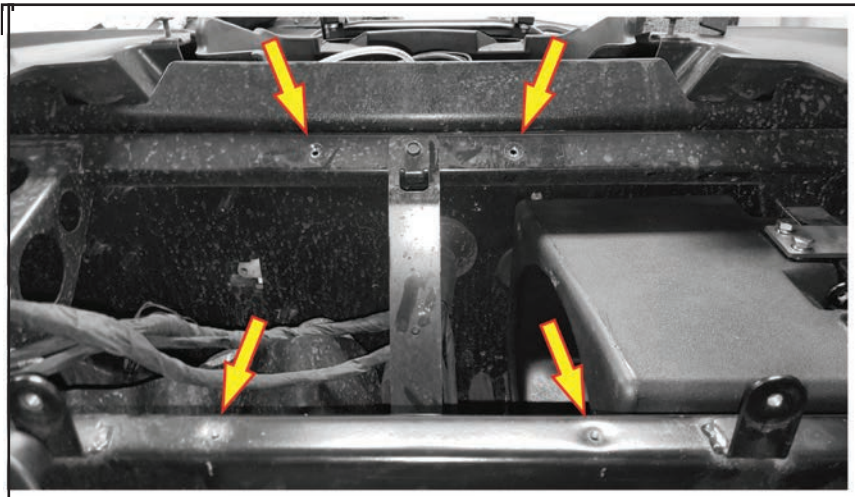

(Figure A)



(Figure B)

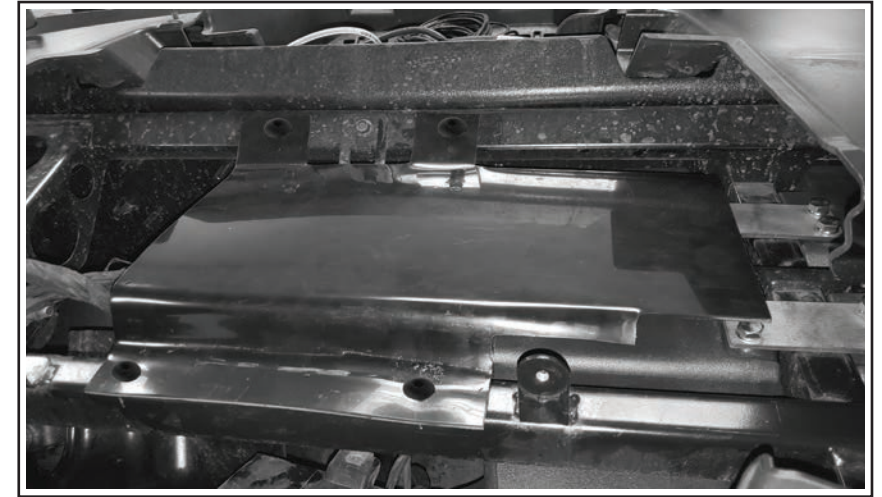

(Figure C)

Continued on next page



# INSTALLATION AMPLIFIER BRACKET 18+

## Amplifier Bracket

2018+

1. The bracket mounts to existing factory points in the middle of the dash directly behind upper pocket or Ride Command display if equipped.  
(Figure D)
2. Use (3) supplied self threading T-40 Torx bolts to mount the amplifier bracket to existing holes in the vehicle.  
(Figure E)

**Note:** The threads may not be cut in the existing holes, if this is the case run the bolts in and out to tap the threads. In the event that there are no factory hole(s), drill a 7/32 hole and use the supplied self-threading T-40 Torx bolts.  
(Figure F)

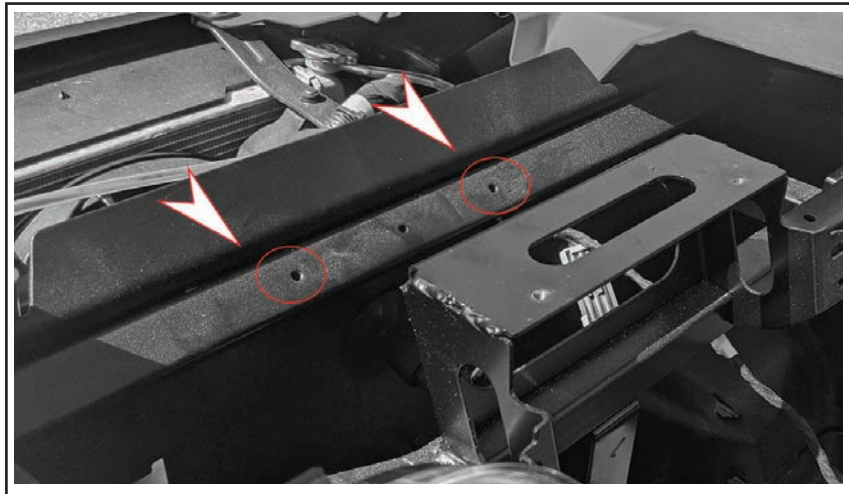

(Figure D)

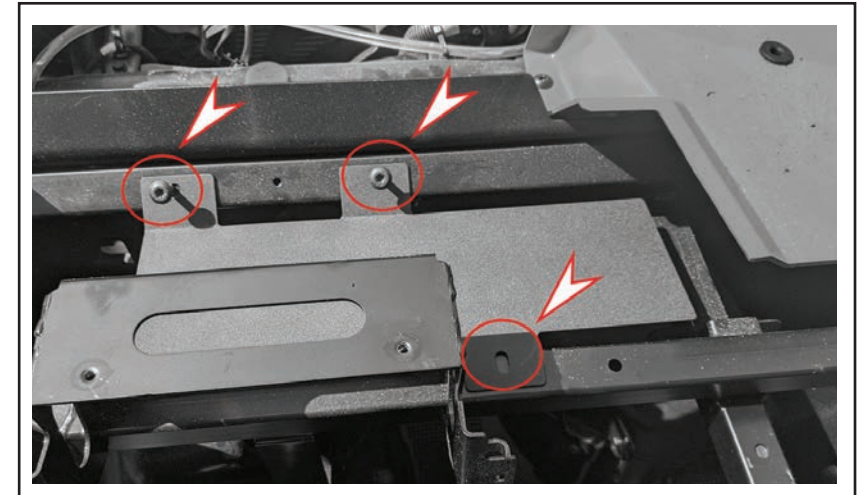

(Figure E)

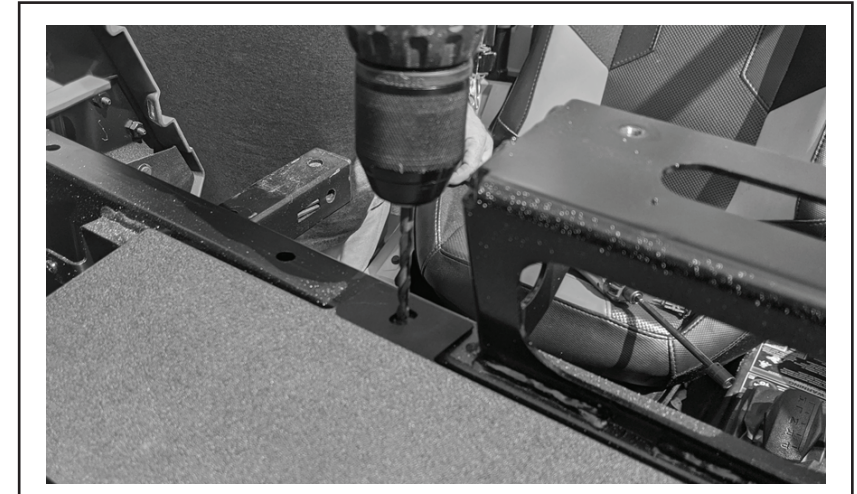

(Figure F)

Continued on next page

## INSTALLATION MPS-RZSP 14+

### Speaker Pod Enclosure

#### Preparation

1. Before mounting the MPS-RZSP pods, drill (2) 5/16 holes in each of the pods at the indented marks.  
(Figure A)
2. Hold the pods up in the correct location on the kick well area.  
(Figure B, page 11)

**Note:** The speaker pods will mount in the same location from 2014+ model RZR.

3. Use a 5/16 bit to drill out the mounting holes.
4. The supplied 1/2 in Head Hex bolts, split washers and lock nuts will be used to attach the pods to the vehicle.
5. Assistance may be needed to tighten the nuts and bolts.

**TIP:** Use silicone to seal around the bolt holes and after the bolts are tightened.

6. Run the speaker wires through the wire hole and seal with silicone.

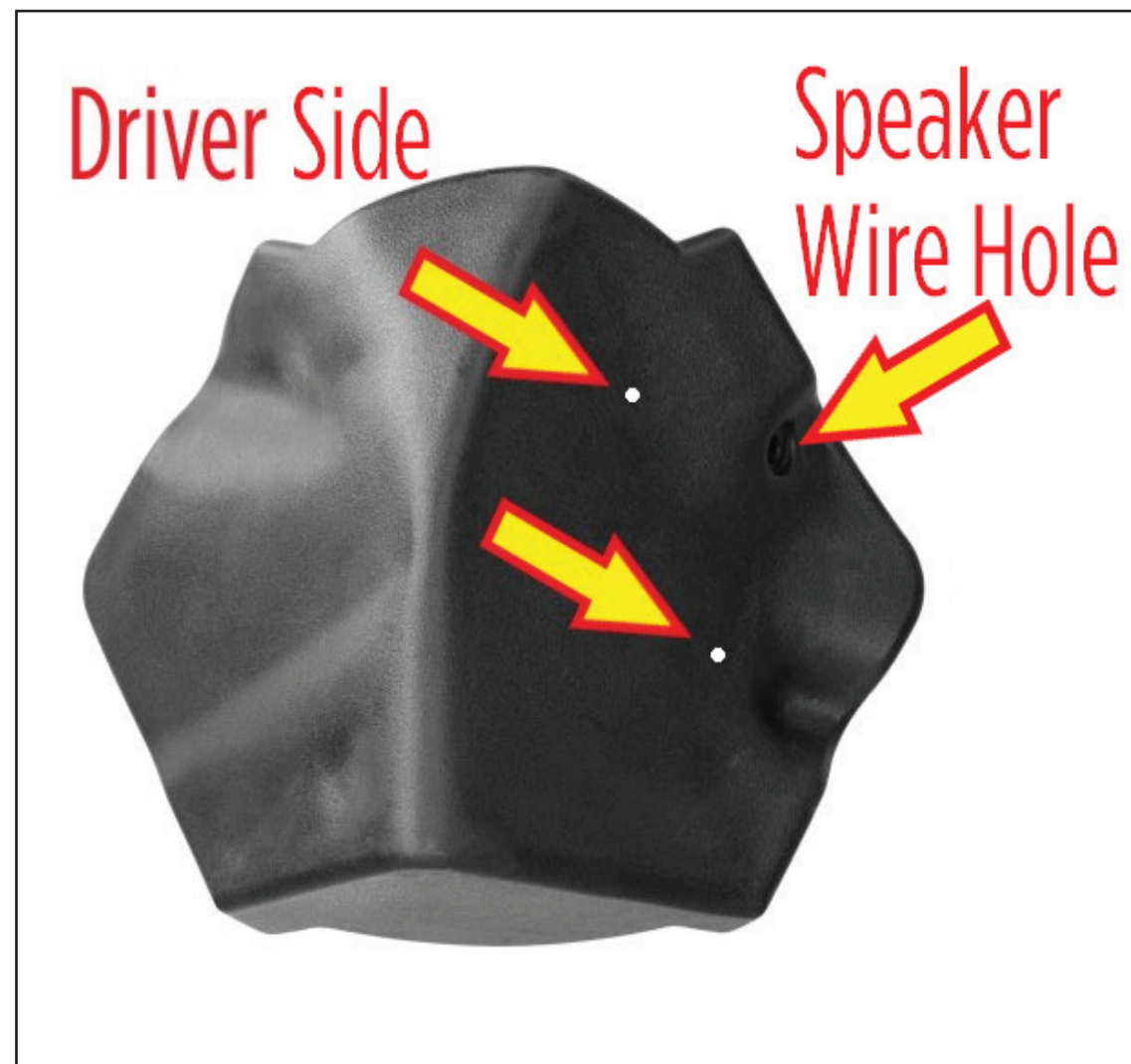

(Figure A)

Continued on next page



## INSTALLATION MPS-RZSP 14+



*(Figure B)*



## SPECIFICATIONS

## MPS-RZKIT INSTALLATION INSTRUCTIONS

### AMP Bracket

14-17 15 x 6.5 in

18+ 14.5 x 4.5 in

### Speaker Enclosure

MPS-RZSB Subwoofer cut Opening 9.2 in dia.

Approx. 0.9 cubic feet

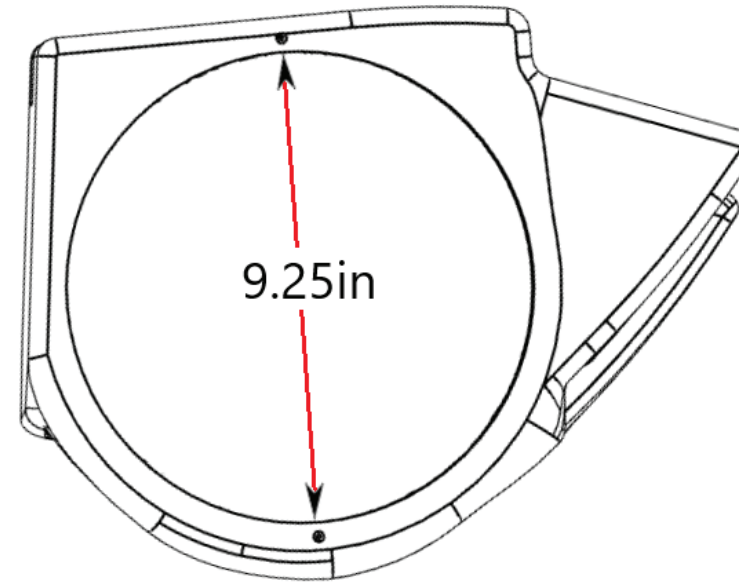

MPS-RZSP Speaker cut Opening 5.75 in dia.

Grill mount 7in dia.

Mounting depth 3.25

Approx. 0.2 cubic feet

Recommended to be used with BC-SGP

