



Installation and Operator's Manual:

Project ES Winch System:

PE2.5 ES (PN 77-50105BW) PE2.5 ES w/Rope (PN 77-53105BW)
PE3.5 ES (PN 77-50112BW) PE3.5 ES w/Rope (PN 77-53112BW)



Table of Contents:

Safety Warnings & Precautions.....	3
Winching Tips & Techniques.....	6
Getting Started:	
Unpacking Your Winch.....	8
Winch Mounting.....	8
Wiring Instructions.....	9
Operation Instructions.....	10
Maintenance.....	12
Troubleshooting.....	12
Parts List.....	13
Warranty.....	17



Safety Warnings

When using this winch, safety precautions should always be followed to reduce the risk of personal injury and damage to the winch.

1) **LEARN TO USE YOUR MILE MARKER WINCH:**

a. After winch has been installed, take some time and practice using it so you will be familiar with ALL OPERATIONS. Periodically check the winch installation to ensure that all bolts are tight.

b. To ensure proper operation, carefully inspect for any damaged parts before operating the winch.

2) **KEEP WINCHING AREA CLEAR:**

Do not allow people to remain in the area during winching operations. Do not step over a taut wire rope or allow anyone else to do so. Due to the possibility of cable failure, direct all personnel to stand clear of any possible pathway. A snapped cable could cause winch failure, injury or death. Keep proper footing and balance at all times. Do not reach over or across the winch and/or pulling cable while the winch is in operation.

3) **INSPECT WIRE ROPE AND EQUIPMENT FREQUENTLY:**

The wire rope should be inspected for damage that could reduce its breaking strength. A frayed rope with broken strands should be replaced immediately. Always replace the rope with a rope that is rated to sustain any load that the winch is capable of pulling. Any substitute must be IDENTICAL in strength, quality, lay and stranding to the Mile Marker cable originally supplied.

4) **WORKING AREA CONDITIONS:**

Keep the working area well lit. Do not use this winch in the presence of flammable gases or liquids.

5) **KEEP CHILDREN AWAY:**

Keep children away from working area. Never let children operate the winch.

6) **DRESS PROPERLY:**

Do not wear loose clothing or jewelry as they can be caught in moving parts. Protective, electrically non-conductive clothes and non-skid footwear is the only type of clothing you should be using when operating the winch. Wear restrictive hair covering to contain long hair.

7) **USE LEATHER GLOVES:**

When handling or rewinding wire rope always use hand protection to eliminate the possibility of cuts caused by burrs & slivers from broken strands.

8) **DRUM ROPE:**

Always make sure that there are at least 5 complete turns of rope left on the drum before winching.

9) **KEEP HANDS AND FINGERS CLEAR OF WIRE ROPE AND HOOK WHEN OPERATING WINCH:**

Never put your finger through the hook when reeling in the last few feet. If your finger should become trapped in the hook or rope, you could lose your finger. Never guide a wire rope under tension onto the drum with your hand.

10) **NEVER HOOK THE ROPE BACK ONTO ITSELF:**

Hooking the rope back onto itself creates an excessive strain that could break individual strands; this, in effect, weakens the entire wire rope.

11) **KEEP PULLING DURATIONS AS SHORT AS POSSIBLE:**

The winch is designed for intermittent use and cannot be used in constant duty applications. Do not pull more than one minute at or near rated load. If the motor becomes too hot to touch, stop and let it cool off for a few minutes. If the motor stalls, cut off the power immediately.

Safety Warnings-Cont'd

When using this winch, safety precautions should always be followed to reduce the risk of personal injury and damage to the winch.

12) DO NOT OVERLOAD:

For your safety and efficient performance, always use this winch at or under its rated capacity for your safety and for better performance. Do not use inappropriate attachments in an attempt to exceed its rated capacity.

13) AVOID CONTINUOUS PULLS FROM EXTREME ANGLES:

This will cause the rope to pile up at one end of the drum. When possible, please get the rope as straight as possible to the direction of the object.

14) NEVER OPERATE THE WINCH WITHOUT THE ROPE FAIRLEAD FITTED:

Operator injury or winch damage can result if a fairlead is not installed.

15) STAY ALERT:

Watch what you are doing. Use your common sense. Do not use this winch when you are tired, stressed or **WHEN UNDER THE INFLUENCE OF DRUGS, ALCOHOL OR MEDICATION.**

16) DISCONNECT SWITCH:

Unplug switch when not in use.

17) REPLACEMENT PARTS & ACCESSORIES:

When servicing, use only identical replacement parts. Usage of any other parts will void the warranty. Approved accessories are available from your local distributor.

Precautions

When using this winch, safety precautions should always be followed to reduce the risk of personal injury and damage to the winch.

- 1) Keeps hands and body away from Fairlead (cable intake slot) when operating.
- 2) Secure vehicle in position before using winch.
- 3) Do not exceed winch load weight capacity (see Winch Specifications).
- 4) Be certain winch is properly bolted to a structure (or vehicle) that can hold the winch load.
- 5) Always use proper couplings when connecting winch cable hook to load.
- 6) Do not lift items vertically. The winch was designed for horizontal use only.
- 7) Do not overload the winch (see Model Specifications). It will do the job better at the load it was intended.
- 8) Do not use inappropriate attachments to extend the length of the winch cable.
- 9) NEVER LIFT PEOPLE OR HOIST LOADS OVER PEOPLE.
- 10) Never come in between the winch and the load when operating.
- 11) Do not apply load to winch when cable is fully extended. Keep AT LEAST 5 FULL TURNS of cable on the drum.
- 12) After moving an item with the winch, secure the item. Do not rely on the winch to hold it for an extended period.
- 13) Examine winch before using. Components may be affected by exposure to everyday weathering, chemicals, salts, and rust.
- 14) Never fully extend cable while under load. Keep 5 COMPLETE TURNS of cable around the winch drum.
- 15) When loading a boat into a trailer without reel or side hull rollers, make sure the trailer is submerged in the water when the boat is loaded by the winch. Attempting to drag the boat on to the trailer while on land can cause winch failure and possible injury.
- 16) Never operate winch if cable shows any signs of weakening, is knotted or kinked.
- 17) Winch does not have a locking mechanism. Secure load after moving.
- 18) Do not cross over or under the cable while it is in process of loading.
- 19) Do not move vehicle with cable extended and attached to load to pull it. The cable could snap.
- 20) Apply blocks (such as a wheel choke) to vehicle when parked on an incline.
- 21) Re-spool cable properly.

Winching Tips & Techniques

WINCHING TIPS AND USE OF A SNATCH BLOCK

- Use OEM tow hooks, recovery eyes or a clevis mount for attachment of a tow strap or winch cable. Warning: Never use a ball and/or ball mount as an anchor point for tow strap or winch cable. Severe personal injury or death could occur.
- Always heed all winch manufacturer's recommendations, cautions, and warnings.
- Attach return cable to tow hook or recovery eye when using a snatch block. Always use a clevis to secure snatch block to strap, or severe damage could occur to persons and vehicle. (See Figure Below). Caution: Never attach return cable to winch mount. This may overload winch mount and/or front receiver.

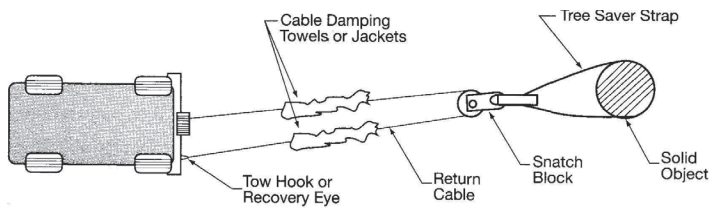

RATING

For maximum line pull rating, winch cable direction must not exceed:

1. 15° angle up or down from horizontal (See Figure Below).
2. 45° angle left or right from straight ahead (See Figure Below).

Caution: Exceeding the maximum line pull rating may overload winch, winch mount, and/or front mounted receiver.

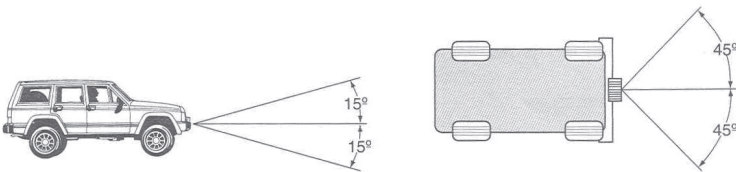

SAFETY TIPS

- NEVER DISENGAGE CLUTCH LEVER WHEN THERE IS A LOAD ON THE WINCH. Mile Marker electric winches utilize an automatic load holding brake, therefore no adjustment to clutch is needed to maintain load.
- Store the remote control cord in a safe place when not in use to prevent use by children or other unauthorized persons who could injure themselves or others or damage the controls.
- Do not operate winch under the influence of drugs, alcohol, or medications.
- Isolate winch before putting hands in or around the fairlead or wire rope drum (The Danger Zone).
- DO NOT OVERLOAD YOUR WINCH. Do not maintain power to the winch if the drum stops. Overloads can damage the vehicle, winch or winch rope and create unstable operating conditions.
- It is recommended to lay a heavy blanket or jacket over the rope about halfway along to the hook attachment. If a rope failure should occur, the weight of the cloth will act as a damper and help prevent the broken rope from whipping (See Figure Below). Remember to move the blanket or jacket as winching proceeds, but halt winching when doing so. Partially raising the hood of the vehicle will also give a measure of protection to its occupants from broken rope or cable, consistent with sufficient forward visibility for the operator.

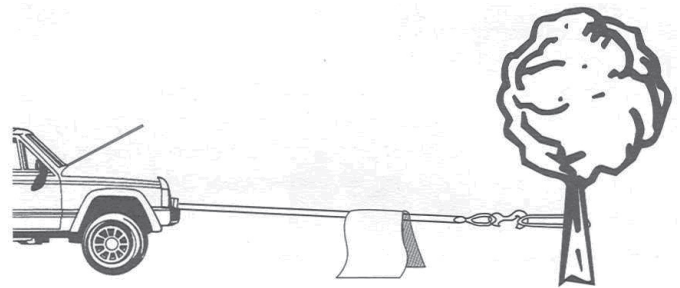

Winching Tips & Techniques

SELF-RECOVERY

1. Always attempt to get the cable as straight as possible to the direction of the vehicle. It is acceptable to start a pull at an angle if it is obvious that the vehicle will turn towards the hook anchoring point. Turning the steering wheel will assist the process. It is recommended that the driver is in the vehicle.
2. Make sure hand brake and foot brake are free and that the transmission is in neutral.
3. When the driver's attempt to regain vehicle traction is successful, he or she should be careful not to overrun the cable and risk the possibility of it being trapped under the vehicle.
4. **DO NOT** move your vehicle in reverse to assist the winch. The combination of the winch and vehicle pulling together could overload the cable and winch itself.

USE OF A PULLEY BLOCK OR SNATCH BLOCK

Vehicle self-recovery using the pulley block attached to the anchor point for direct pull. In this instance the vehicle becomes the "load" and the actual pulling power on the vehicle will be double at half winch rope speed. Never connect wire rope or hook back to winch mount!

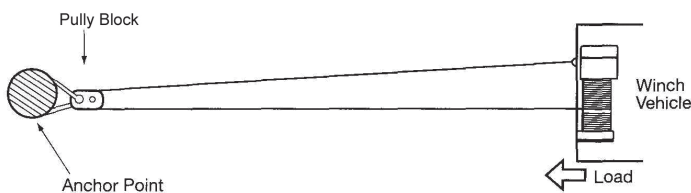

Below: Direct pull on load using the winch vehicles as the anchor with pulley block attached to the load.

The most important aid to successful winching (after the winch) is the pulley block, which can be used to increase the pulling power of the winch or for indirect pulls. Pulley blocks can be used in two modes. First mode is attached to the load and second is secured to an anchor point.

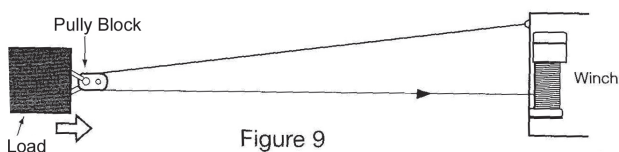

Below: Indirect pull necessitated by obstructions or soft ground. Pulley block attached to load using a suitable anchor point. Note the angled direction taken by the load and subsequent angle of rope feed-back on the winch drum (extreme example shown). There may be unavoidable circumstances requiring this mode, though in general it is not recommended unless applied in stages by moving the anchor point or vehicle to avoid the sharp angled rewind on the winch drum. The actual load pulling power and rope speed will depreciate with any increased angle between the ropes.

The anchor point, when used must be secure, using a tree, another vehicle or any firm structure to which a pulley block can be used to your advantage.

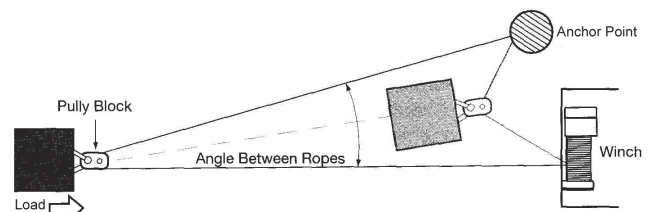

USE OF A NYLON SLING AND SHACKLE

- A shackle should always be used when attaching winch hooks to nylon slings. **NOTE:** The shackle must pass through both eyes of the sling. The safe working load of the nylon sling is based on the use of both eye ends. Never use the cable or hook to connect directly to the nylon sling.

USE OF GLOVES

- When handling or rewinding the cable always use gloves to eliminate the possibility of cuts caused by burrs and broken strands. Inspect cable and equipment frequently. The cable should be replaced immediately if any sign of burrs or broken strands are evident. A frayed cable with broken strands should be replaced immediately. Always replace the cable with a Mile Marker recommended replacement part. Any substitution must be **IDENTICAL** in strength, quality, lay and stranding. Never hook the cable back onto itself. Hooking the cable back onto itself creates an unacceptable strain, breaking individual strands which in turn weakens the entire cable. Use a sling. Avoid continuous pulls from extreme angles as this causes cable to pile up at one end of the drum.

Getting Started

Unpacking Your Winch

- Unpack your new Mile Marker winch and ensure that all the parts are included by referring to parts list and exploded view drawings provided in this manual.

NOTE: If you find any missing or broken parts, please call Mile Marker as soon as possible at the number present on the cover page of this manual.

Mounting Options

When installing a winch, your installation may vary from the manual diagrams and instructions included here due to physical vehicle differences. Always disconnect the battery from the vehicle to before starting installation.

If you choose NOT to use an ATV mounting kit you may be required to drill holes in a structural support on the ATV. Be sure the location will be strong enough to support the rated pulling force of the winch. **DO NOT DRILL INTO OR NEAR WIRING OR GAS TANK!**

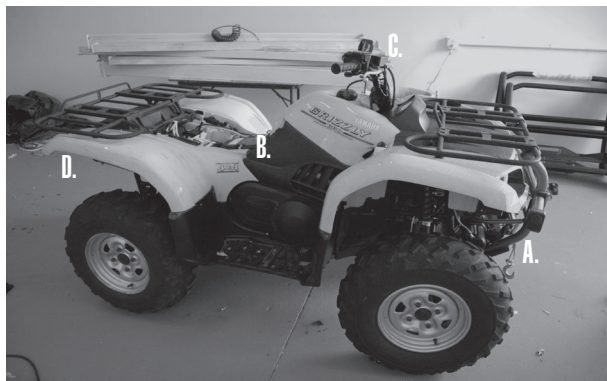

1-1: Mounting Points used in this installation: (A) Winch and Mount, (B) Under Seat Control Box Mounting, (C) Handlebar Pendant Mount, (D) Remote Pendant Receiver Location

Winch Mounting

NOTE: Mile Marker recommends the use of its mounting systems for proper winch installation and optimum winch performance. However, when not using Mile Marker Mounting System, ensure that the mounting platform is strong enough to meet the maximum rated load of the winch in use.

Your Winch should be aligned and secured to a solid part of the vehicle (front or rear) where the full rated load will be evenly distributed.

CAUTION: It is essential that the mounting surface be flat and the winch is mounted such that the three major sections (Gear housing end, drum and motor end) are in proper alignment.

1. Install the mounting kit or prepare a flat and secure location on the ATV for the winch. The winch mount kit has it's own instructions for the intended ATV.
2. Position the winch over the mount and check for operation of the clutch lever to frame clearance. Check for tire to winch clearance. If ok, continue on to the next step.
3. Secure the winch to the mounting bracket or surface chosen with the correct hardware.

NOTE: Make sure the winch mounting bolts and winch hardware has been checked for proper torque. Sometimes it may be necessary to remove the cable from the winch drum to install the mounting hardware or roller/hawse fairlead. All Mile Marker Mounting Systems come fairlead ready. If you are using any other mounting platforms, drill two holes for the roller fairlead installation. Position the holes such that the fairlead opening hole stretches from the circumference of the drum to the end of the maximum permissible layers on the drum in the direction cable is being rolled.

Wiring Instructions

NOTE: Be sure to mount control box in a location that: (a) does not interfere with any vehicle's moving / functioning parts, and (b) use electrical cables with similar or better specifications as that provided by Mile Marker if a substitution is required.

CAUTION: Battery cables should not be drawn taut; leave some slack for cable movement. Also, ensure that they are routed properly with out any interference with the vehicular components that could potentially damage the cable or cause electrical short.

Long battery cable runs may have significant voltage drops that may cause the winch motor controller to not operate properly.

DO NOT CONNECT POWER CABLES TO BATTERY UNTIL FINAL STEP OF INSTALLATION!

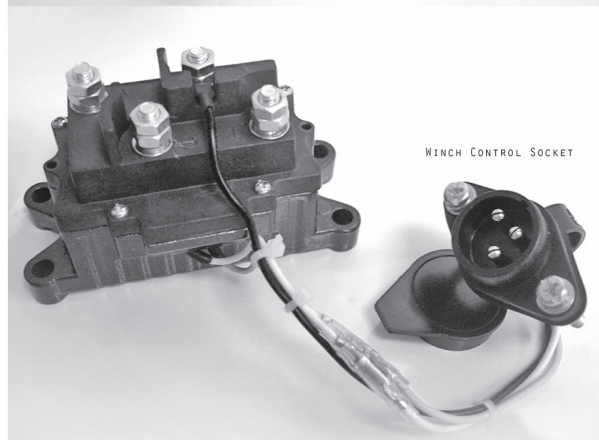
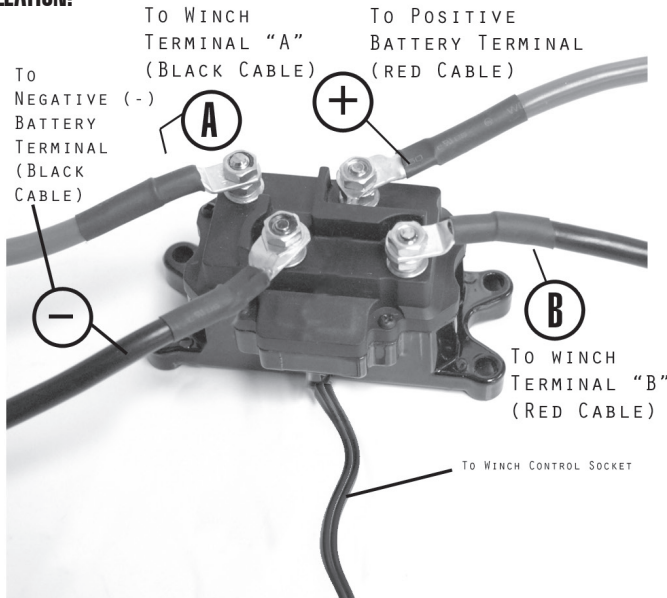

2-1: Wiring Diagram

Winch Operation

Function Testing

After checking all connections in accordance to installation instructions prior, connect power cables to vehicle's battery. Attach Black Cable to Negative (-) Battery Terminal and secure, followed by attaching the Red Cable to Positive (+) Battery Terminal.

1. Before testing the winch, turn the clutch handle to the "Freespool" position. Always wear heavy gloves when handling winch cable. Using a Mile Marker hook strap, pull about two feet of cable off the winch drum, and place the clutch handle in the "Engaged" position (fig. 3-1).

2. Toggle the Joystick "down" to retrieve line. When using the handlebar remote, you can also toggle the "IN" button for the same retrieval function (fig. 3-2). Winch cable will spool in on drum.

NOTE: If cable is spooled "Out" while pressing the "IN" function, please refer to Figure 2-1, and switch power cables to opposite studs on motor.

4. Toggle the Joystick "up" to Power Out winch cable. When using the handlebar remote, you can also toggle the "OUT" button for the same Power Out function (fig. 3-2). Winch Cable will spool out off of drum.

CAUTION: The "OUT" function is for INTERMITTENT USE ONLY, as you are powering drum against the brake, and can damage internal mechanism.

5. If any of the above functions are not working properly, recheck all connections in accordance with Installation Section of this manual, or refer to Troubleshooting Section in back of manual.

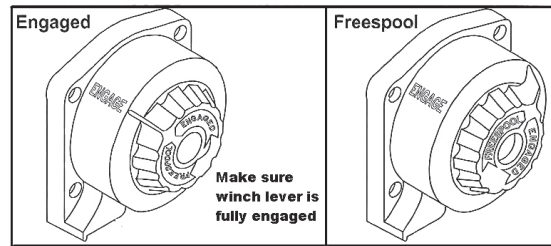

3-1: Clutch Function Diagram



3-2: Remote Control Function Diagram

Winch Operation

NOTE:For optimal winch performance, it is recommended that you use a fully charged 12V battery with at least 150 Cold Cranking Amperes. Further, it is advised to keep the engine running during the winch operation, so that the battery is being charged continuously.

CAUTION: Before you start using your new Mile Marker winch, you will have to re-wind the entire cable on the drum under a load of at least 100 lbs starting with at least 5 wraps on the initial layer. Failure to do so will result in the outer wraps pressing against the inner wraps resulting in the damage of the cable.

Always have at least 5 wraps of cable on the winch drum before winching.

Always ensure that the clutch is fully engaged or fully disengaged to avoid any injuries and damages.

All electrical winches are for intermittent use only. Never run the winch for more than 1 min at maximum rated load. Wait until the motor cools down before resuming winching operation. Usage of a snatch block is recommended to reduce the load on the winch motor.

Always stay clear of the loaded winch cable.

Clutch Operation:

The clutch is operated by rotating the clutch lever clockwise for “Free” and counter clock wise for “Locked or Engaged” (figure 3-1).

Never release the cable while under tension. Doing this can badly damage the winch and/or cause property damage and serious injury.

Motor Temperature:

ELECTRIC WINCHES ARE DESIGNED FOR INTERMITTENT USE ONLY. Do not run this winch at a high load for an extended period of time. To check the motor temperature: Stop Operation, Secure the load, Release the tension on the cable, and place your hand on the motor to check temperature. If you feel the motor is warm to the touch, let it cool off for a few minutes. If the motor is laboring, stop sooner and more often to check the motor temperature. Using a double line with a snatch block will reduce the load on the winch to about half. The lower the amp load on the winch the longer it will take to heat up the motor.

Spooling Under Load:

Always ensure that wire rope passes between winch drum & mounting surface. Always wind the rope as evenly and tight as possible. Avoid shock loading the winch when spooling in. If this is done you can cause a hazardous condition that can break the wire or damage the winch. Avoid pulling at an angle for an extended period. This will stack the wire up on side of the spool and cause serious damage to the winch. You may have to reposition the wire a few times to allow the winch to pull in a straight line.

Rigging:

Spool out as much wire as possible to the farthest object available. Keep the wire in as straight a line as you can. Spool the line back on the winch as evenly as possible when retrieving the wire rope. Natural anchors like trees, stumps and rocks are the better choices. Always use a tree saver where ever possible. Only connect the wire rope to an object that will be able to resist the pulling power of the winch being used.



3-2: Remote Control Function Diagram

Winch Maintenance

- All moving parts within the Electric Winch have been lubricated using high temperature lithium grease at the factory. No further internal lubrication is required for the life of the winch.
- Lubricate the cable periodically using light penetrating oil.
- Electrical connections may corrode over a period of time due to environmental changes. This may result in reduced performance of the winch or even possible electrical shorting. Hence, always clean the electrical connections before and after using the winch.
- After every use of the winch, inspect the cable for damages such as kinks, broken strands etc. When damaged, replace the cable immediately!

CAUTION: It is recommended that you replace the cable with superior Mile Marker cables. If replacing from other sources, carefully compare for the maximum load capacity of the cable with that mentioned in the Specifications Section of this manual.

Troubleshooting

SYMPTOM	POSSIBLE	SUGGESTED
Motor does not turn on	Remote control switch is not turned on.	Turn on Remote control switch.
	LED green, blue, red alternate flashing.	Temperature Over-Heat shutdown, let winch cool down.
	Red green LED flashes.	Low Voltage Warning. Recharge battery.
	Loose battery cable.	Tighten nuts on cable connectors.
	ATV Control Box malfunctioning	If the LEDs do not light up on the Remote Control, and the battery is fully charged, then the control box needs to be replaced.
	Defective motor	Check for voltage at armature port with switch pressed. If voltage is present, replace motor.
	Water has entered motor	Drain and dry. Run in short bursts without load until completely dry.
Motor runs too hot	Long period of operation	Let winch cool down periodically.
Motor runs slowly or without normal power	Battery runs down.	Recharge battery by running vehicle's engine.
	Insufficient current or voltage	Clean, tighten or replace the connector.
Motor runs but cable drum does not turn.	Clutch not engaged	Ensure lever is completely in "engaged" position. If that does not work, contact qualified technician to check and repair.
Motor runs in one direction only	ATV control box is defective or damaged.	Replace control box.

Parts Breakdown & Assembly: PE 2.5

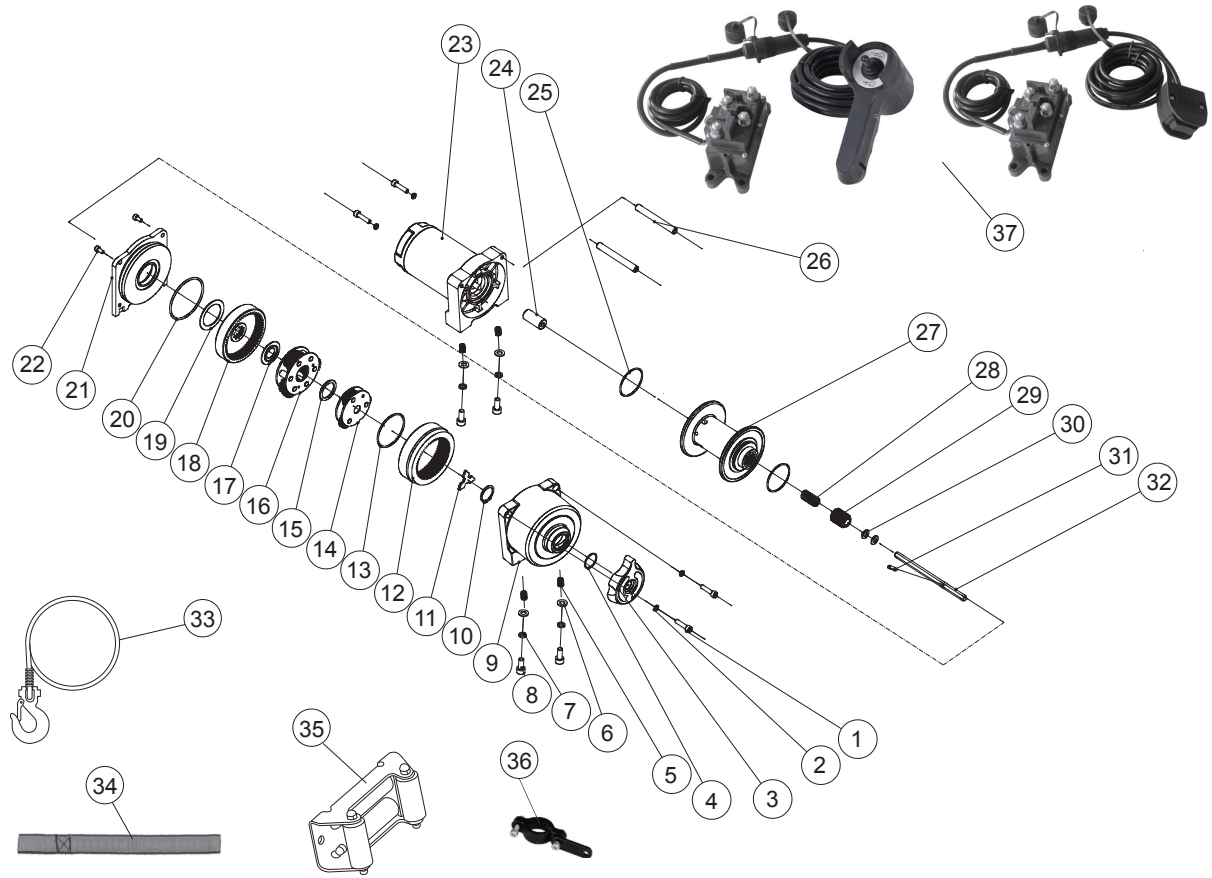

Item	Quantity	Part Number	Description
1	4	77-50105-01	SCREW
2	4	77-50105-02	SPRING WASHER
3	1	77-50105-03	CLUTCH KNOB
4	1	77-50105-04	O RING
5	1	77-50105-05	COIL
6	4	77-50105-06	SPACER
7	1	77-50105-07	SPRING WASHER
8	1	77-50105-08	SCREW
9	1	77-50105-09	GEAR BOX
10	1	77-50105-10	SPRING RETAINER
11	1	77-50105-11	CLUTCH DRIVEN DISC
12	1	77-50105-12	DUAL GEAR RING
13	1	77-50105-13	RING
14	1	77-50105-14	GEAR CARRIER-INPUT
15	1	77-50151-15	WASHER
16	1	77-50105-16	GEAR CARRIER-OUTPUT
17	1	77-50105-17	NYLON RETAINING RING
18	1	77-50105-18	GEAR DISC-OUTPUT
19	1	77-50115-19	WASHER
20	1	77-50105-20	O-RING

Item	Quantity	Part Number	Description
21	1	77-50105-21	COVER-GEARBOX
22	2	77-50105-22	SCREW
23	2	77-50105-23	MOTOR END
24	1	77-50105-24	CONNECTOR
25	1	77-50105-25	O RING
26	1	77-50105-26	TIE BAR
27	1	77-50105-27	DRUM
28	1	77-50105-28	SPRING-CLUTCH
29	1	77-50105-29	CLUTCH GEAR
30	1	77-50105-30	WASHER
31	1	77-50105-31	SCREW
32	1	30-50040	DRIVEN AXLE
33	1	77-50105-33	CABLE
34	4	7-50105-34	HAND STRAP
35	1	NA: SEE ITEM 38	ROLLER FAIRLEAD
36	1	WH2	HANDLE BAR CLAMP
37	1	77-50105-37	SOLENOID ASSY +REMOTE CONTROL (OPTIONAL)

Parts Breakdown & Assembly: PE 2.5 w/Rope

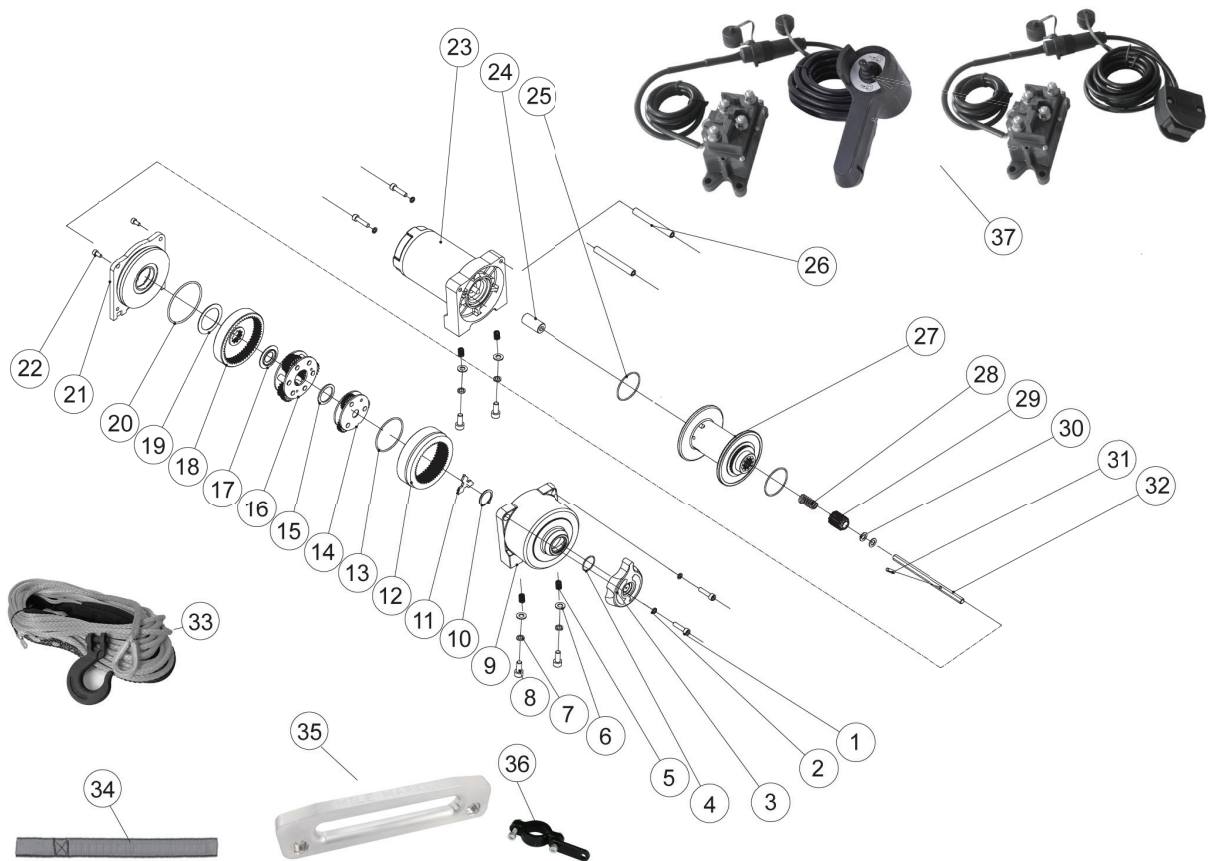

Item	Quantity	Part Number	Description
1	4	77-50105-01	SCREW
2	4	77-50105-02	SPRING WASHER
3	1	77-50105-03	CLUTCH KNOB
4	1	77-50105-04	O RING
5	1	77-50105-05	COIL
6	4	77-50105-06	SPACER
7	1	77-50105-07	SPRING WASHER
8	1	77-50105-08	SCREW
9	1	77-50105-09	GEAR BOX
10	1	77-50105-10	SPRING RETAINER
11	1	77-50105-11	CLUTCH DRIVEN DISC
12	1	77-50105-12	DUAL GEAR RING
13	1	77-50105-13	RING
14	1	77-50105-14	GEAR CARRIER-INPUT
15	1	77-50151-15	WASHER
16	1	77-50105-16	GEAR CARRIER-OUTPUT
17	1	77-50105-17	NYLON RETAINING RING
18	1	77-50105-18	GEAR DISC-OUTPUT
19	1	77-50115-19	WASHER
20	1	77-50105-20	O-RING

Item	Quantity	Part Number	Description
21	1	77-50105-21	COVER-GEARBOX
22	2	77-50105-22	SCREW
23	2	77-50105-23	MOTOR END
24	1	77-50105-24	CONNECTOR
25	1	77-50105-25	O RING
26	1	77-50105-26	TIE BAR
27	1	77-50105-27	DRUM
28	1	77-50105-28	SPRING-CLUTCH
29	1	77-50105-29	CLUTCH GEAR
30	1	77-50105-30	WASHER
31	1	77-50105-31	SCREW
32	1	30-50040	DRIVEN AXLE
33	1	77-50105-33	SYNTHETIC ROPE
34	4	7-50105-34	HAND STRAP
35	1	NA: SEE ITEM 38	HAWSE FAIRLEAD
36	1	WH2	HANDLE BAR CLAMP
37	1	77-50105-37	SOLENOID ASSY +REMOTE CONTROL (OPTIONAL)

Parts Breakdown & Assembly: PE 3.5

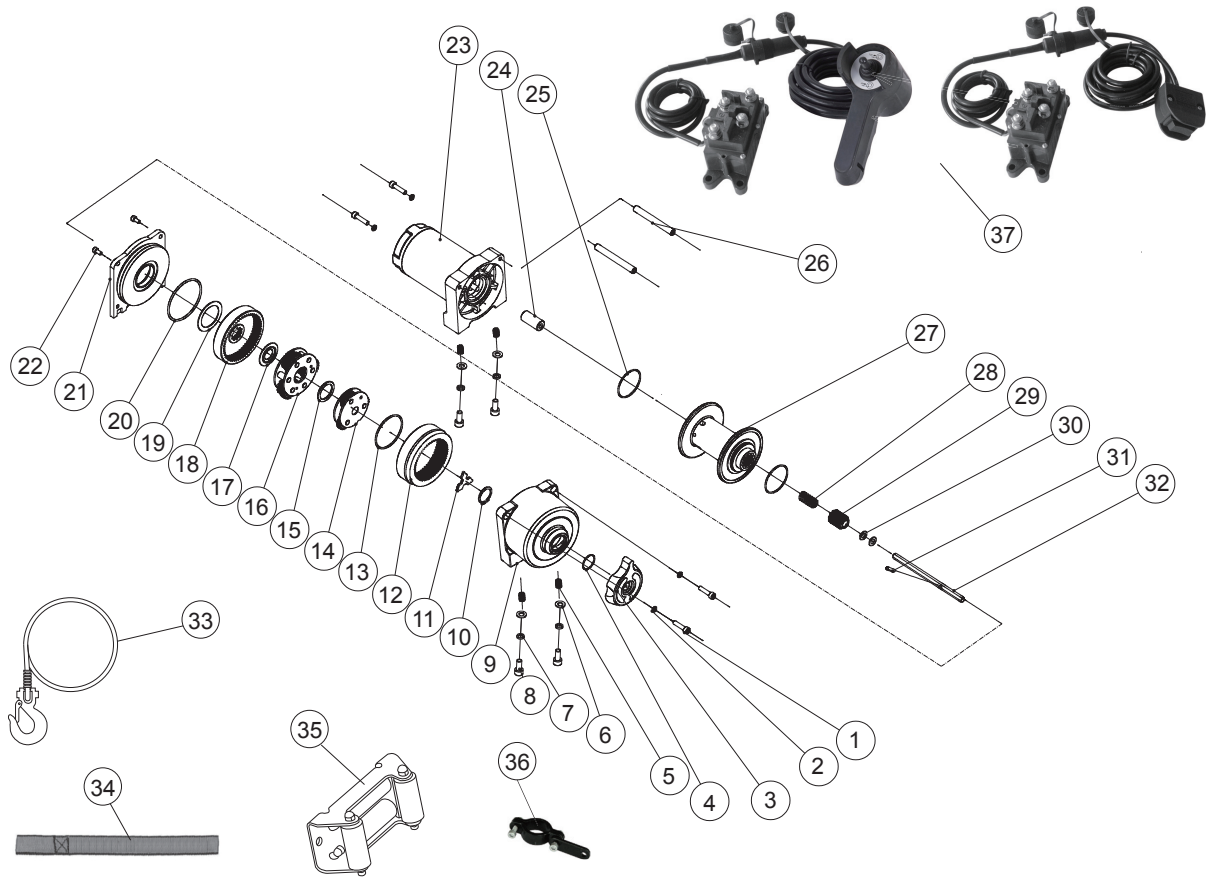

Item	Quantity	Part Number	Description
1	4	77-50105-01	SCREW
2	4	77-50105-02	SPRING WASHER
3	1	77-50105-03	CLUTCH KNOB
4	1	77-50105-04	O RING
5	1	77-50105-05	COIL
6	4	77-50105-06	SPACER
7	1	77-50105-07	SPRING WASHER
8	1	77-50105-08	SCREW
9	1	77-50105-09	GEAR BOX
10	1	77-50105-10	SPRING RETAINER
11	1	77-50105-11	CLUTCH DRIVEN DISC
12	1	77-50105-12	DUAL GEAR RING
13	1	77-50105-13	RING
14	1	77-50105-14	GEAR CARRIER-INPUT
15	1	77-50151-15	WASHER
16	1	77-50105-16	GEAR CARRIER-OUTPUT
17	1	77-50105-17	NYLON RETAINING RING
18	1	77-50105-18	GEAR DISC-OUTPUT
19	1	77-50115-19	WASHER
20	1	77-50105-20	O-RING

Item	Quantity	Part Number	Description
21	1	77-50105-21	COVER-GEARBOX
22	2	77-50105-22	SCREW
23	2	77-50105-23	MOTOR END
24	1	77-50105-24	CONNECTOR
25	1	77-50105-25	O RING
26	1	77-50105-26	TIE BAR
27	1	77-50105-27	DRUM
28	1	77-50105-28	SPRING-CLUTCH
29	1	77-50105-29	CLUTCH GEAR
30	1	77-50105-30	WASHER
31	1	77-50105-31	SCREW
32	1	30-50040	DRIVEN AXLE
33	1	77-50105-33	CABLE
34	4	7-50105-34	HAND STRAP
35	1	NA: SEE ITEM 38	ROLLER FAIRLEAD
36	1	WH2	HANDLE BAR CLAMP
37	1	77-50105-37	SOLENOID ASSY +REMOTE CONTROL (OPTIONAL)

Parts Breakdown & Assembly: PE 3.5 w/Rope

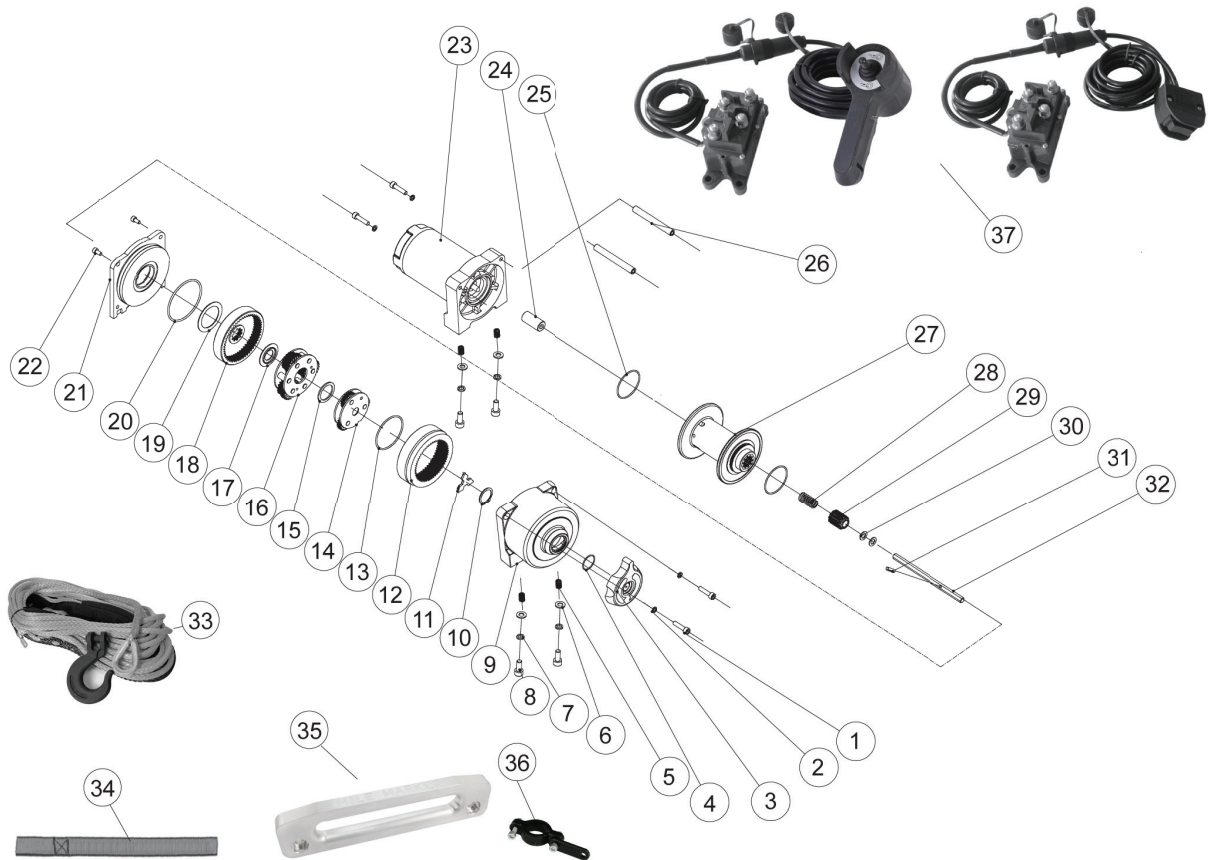

Item	Quantity	Part Number	Description
1	4	77-50105-01	SCREW
2	4	77-50105-02	SPRING WASHER
3	1	77-50105-03	CLUTCH KNOB
4	1	77-50105-04	O RING
5	1	77-50105-05	COIL
6	4	77-50105-06	SPACER
7	1	77-50105-07	SPRING WASHER
8	1	77-50105-08	SCREW
9	1	77-50105-09	GEAR BOX
10	1	77-50105-10	SPRING RETAINER
11	1	77-50105-11	CLUTCH DRIVEN DISC
12	1	77-50105-12	DUAL GEAR RING
13	1	77-50105-13	RING
14	1	77-50105-14	GEAR CARRIER-INPUT
15	1	77-50151-15	WASHER
16	1	77-50105-16	GEAR CARRIER-OUTPUT
17	1	77-50105-17	NYLON RETAINING RING
18	1	77-50105-18	GEAR DISC-OUTPUT
19	1	77-50115-19	WASHER
20	1	77-50105-20	O-RING

Item	Quantity	Part Number	Description
21	1	77-50105-21	COVER-GEARBOX
22	2	77-50105-22	SCREW
23	2	77-50105-23	MOTOR END
24	1	77-50105-24	CONNECTOR
25	1	77-50105-25	O RING
26	1	77-50105-26	TIE BAR
27	1	77-50105-27	DRUM
28	1	77-50105-28	SPRING-CLUTCH
29	1	77-50105-29	CLUTCH GEAR
30	1	77-50105-30	WASHER
31	1	77-50105-31	SCREW
32	1	30-50040	DRIVEN AXLE
33	1	77-50105-33	SYNTHETIC ROPE
34	4	7-50105-34	HAND STRAP
35	1	NA: SEE ITEM 38	HAWSE FAIRLEAD
36	1	WH2	HANDLE BAR CLAMP
37	1	77-50105-37	SOLENOID ASSY +REMOTE CONTROL (OPTIONAL)