



FULL LINE BROCHURE

PELICAN™ AIR CASES



SINCE 1976

PELICAN™ AIR

PELICAN™ AIR. UP TO 40% LIGHTER. GUARANTEED FOR LIFE.

PELICAN™ AIR: THE LIGHTEST POLYMER PROTECTOR CASES ON THE PLANET

At up to 40% lighter than other polymer cases, Pelican™ Air cases will lighten the loads of the dedicated pros around the world who have set out to change the game.

Pelican™ Air cases are the first in a series of remarkable innovations engineered by Pelican, the pioneers of protective cases. For over 40 years Pelican has designed and crafted the most influential protective cases in the world, and we're just getting started.

With the launch of the Pelican™ Air line of cases, we're redefining the future of protection with a remarkable union of lightweight and toughness.

Pelican™ Air. Up to 40% lighter. Guaranteed for life.





MISSION:

Recon Training Exercise

PROTECTION REQUIREMENT:

- 1525 Air/Satellite Phone, Antenna
- 1555 Air/ Night Vision Scope, Tripod



THE SCIENCE BEHIND STRENGTH AND LIGHTNESS

The Pelican™ Air case has been designed to cut weight without compromising durability. Our engineers have revolutionized the protector case by reducing structural waste while preserving Pelican's legendary standards of strength. In development for years, the design team challenged the status quo to "add lightness" to every detail.

Here are some important reasons why Pelican™ Air cases are both strong and light:

- Molded from the next generation of Pelican's lightweight HPX™ resin, a proprietary formula that rebounds without breaking
- Honeycomb structural elements that are actually stronger than solid polymer material
- Super-stiff "full box" sections are engineered to create hollow parts

EXTREME ENGINEERING—UP TO 40% LIGHTER

Pelican™ Air	Weight (lbs)	Pelican Equivalent	Weight (lbs)	% var.
1525	5.99 (2.7 kg)	1520	8.29 (3.8 kg)	-28%
1535	8.69 (3.9 kg)	1510	11.99 (5.4 kg)	-28%
1555	7.37 (3.3 kg)	1550	10.58 (4.8 kg)	-35%
1557	6.60 (3.0 kg)	1520	8.29 (3.8 kg)	-21%
1605	9.28 (4.2 kg)	1600	13.00 (5.9 kg)	-33%
1607	13.20 (6.0 kg)	1560	17.00 (7.7 kg)	-22%
1615	14.06 (6.4 kg)	1670	23.00 (10.4 kg)	-40%
1637	15.20 (6.9 kg)	1620	21.20 (9.6 kg)	-21%

*Case weights are actual and percentage variance is adjusted for cubic inch interior volume.

UP TO THE TEST

It wouldn't be a Pelican™ case if you couldn't drop it, kick it and run over it – and the Pelican™ Air case is no different.

- Drop-tested on concrete on all sides and corners with loads from six feet
- Submerged for 30 minutes at a depth of one meter
- Wheels are roll tested over 914 meters
- 28 lb. (12.7 kg) steel dart dropped on all sides from one meter



TRAVEL LIGHT

The world is in a hurry and Pelican™ Air cases are setting the pace with two models optimized for travel. We aggregated the airline rules for maximum overhead and check-in dimensions, and perfected two cases for pros on the move. Both cases include a rugged extendable trolley handle that keeps the case clear of your heels when walking, and smooth rolling ball bearing wheels that are strong, but quiet.

Getting through the airport with a Pelican™ Air case is a lot easier, and saves money on over-weight baggage fees, too.



1535 AIR – WHEELED CARRY-ON

Weighing just 8.69 lbs. with exterior dimensions of 21.96 x 13.97 x 8.98 inches, Pelican™ Air 1535 is optimized for carry-on/overhead bin size. (3.9 kg, 55.8 x 35.5 x 22.8 cm)

1615 AIR – WHEELED CHECK-IN

Weighing just 14.06 lbs. with exterior dimensions of 32.58 x 18.40 x 11.02 inches, Pelican™ Air 1615 is the maximum airline dimensions for checked baggage without oversize charges. (6.4 kg, 82.8 x 46.7 x 28 cm)



ASSIGNMENT:

Dual Sport Motorcycle Adventure

PROTECTION REQUIREMENT:

- 1485 Air/DSLR, 14-24 mm Lens, 200 mm Lens
- 1535 Air/15" Laptop, BackupBattery



PELICAN™ AIR CASE FEATURES

With inventive features that anticipate the needs of pros from every line of work, the new Pelican™ Air models offer innovation with an equal balance of toughness and lightness. Every pro will discover a more effortless user experience and the perfect model in the Pelican™ Air line.

SHARED FEATURES ACROSS ALL MODELS:

- Super-light Proprietary HPX™ Polymer
- Proven Tough Double-Throw Latches
- Automatic Purge Valve Balances Air Pressure
- Watertight O-Ring Gasket
- New Style “Conic Curve” Lid Shape
- Crushproof and Dustproof
- Stainless Steel Hasp Protectors
- Rubber Overmolded Handles
- New Removable Polycarbonate Card Holder With Front or Side Placement



PELICAN™ AIR





EMERGENCY:

Search and Rescue

PROTECTION REQUIREMENT:

- 1555 Air/Trauma Kit
- 1605 Air/Neck Brace, Airway Kit
- 1615 Air/ Meds Kit, Oxygen

PELICAN™ AIR

CASE CONFIGURATIONS



No Foam



Pick N Pluck™ Foam



Padded Dividers

Available in Black Cases Only



TrekPak™ Dividers

Available in Black Cases Only
Not Available in the 1607 and 1637



1485 AIR

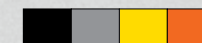

- Interior dimensions (L x W x D)
17.75" x 10.18" x 6.15" (45.1 x 25.9 x 15.6 cm)
- Exterior dimensions (L x W x D)
19.17" x 12.80" x 6.89" (48.7 x 32.5 x 17.5 cm)
- 4.57 lbs (2.1 kg)



1525 AIR

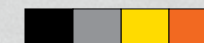

- Interior dimensions (L x W x D)
20.50" x 11.3" x 6.75" (52.1 x 28.7 x 17.1 cm)
- Exterior dimensions (L x W x D)
21.96" x 13.97" x 7.49" (55.8 x 35.5 x 19 cm)
- 5.99 lbs (2.7 kg)



1535 AIR

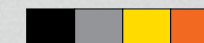

- Interior Dimensions (L x W x D)
20.39" x 11.20" x 7.20" (51.8 x 28.4 x 18.3 cm)
- Exterior dimensions (L x W x D)
21.96" x 13.97" x 8.98" (55.8 x 35.5 x 22.8 cm)
- 8.69 lbs (3.9 kg)
- Maximum airline carry-on size



1555 AIR

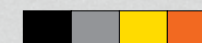

- Interior dimensions (L x W x D)
23.00" x 12.75" x 7.50" (58.4 x 32.4 x 19.1 cm)
- Exterior dimensions (L x W x D)
24.76" x 15.46" x 8.24" (62.9 x 39.3 x 20.9 cm)
- 7.37 lbs (3.3 kg)



1605 AIR

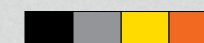

- Interior dimensions (L x W x D)
26.00" x 14.00" x 8.38" (66 x 35.6 x 21.3 cm)
- Exterior dimensions (L x W x D)
28.87" x 16.77" x 9.12" (73.3 x 42.6 x 23.2 cm)
- 9.28 lbs (4.2 kg)



1615 AIR

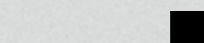

- Interior dimensions (L x W x D)
29.59" x 15.50" x 9.38" (75.2 x 39.4 x 23.8 cm)
- Exterior dimensions (L x W x D)
32.58" x 18.40" x 11.02" (82.8 x 46.7 x 28 cm)
- 14.06 lbs (6.4 kg)
- Maximum airline check-in size

NEW DEEPER SIZES



1557 AIR

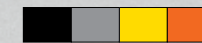

- Interior dimensions (L x W x D)
17.33" x 13.00" x 9.75" (44.0 x 33.0 x 24.8 cm)
- Exterior dimensions (L x W x D)
19.18" x 15.79" x 10.50" (48.7 x 40.1 x 26.7 cm)
- 6.60 lbs (3.0 kg)



1607 AIR

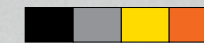

- Interior dimensions (L x W x D)
21.05" x 15.81" x 11.63" (53.5 x 40.2 x 29.5 cm)
- Exterior dimensions (L x W x D)
24.13" x 18.80" x 13.25" (61.3 x 47.8 x 33.7 cm)
- 13.20 lbs (6.0 kg)



1637 AIR

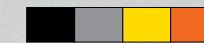

- Interior dimensions (L x W x D)
23.43" x 17.55" x 13.25" (59.5 x 44.6 x 33.7 cm)
- Exterior dimensions (L x W x D)
26.61" x 20.65" x 14.87" (67.6 x 52.5 x 37.8 cm)
- 15.20 lbs (6.9 kg)

INCLUDED ON ALL CASES

- Business card holder
- Automatic purge valve

WHEELED CASES

- Quiet rolling stainless-steel bearing wheels
- Extending trolley handle



INDUSTRY:

Power Grid Maintenance

PROTECTION REQUIREMENT:

- 1485 Air/Digital Multimeter
- 1555 Air/Logic Analyzer
- 1605 Air/Oscilloscope



EFFORTLESS PROTECTION – EASY PICK N PLUCK™ FOAM



Pelican™ Air cases have been designed to protect equipment of all kinds, no matter the size or shape. Most Pelican protector cases come with our Pick N Pluck™ shock-absorbent foam, pre-scored in tiny cubes. The item is placed on the foam, outlined with chalk, and then the cubes around the item are removed to form a secure, protective cocoon.

NEW DIVIDER SYSTEM

- Full Sewn Tub with Felt Exterior
- Velcro™ Compatible Nyllex™ Interior
- Elastic Hold Down Straps
- Hi-Visibility Yellow Interior
- Set Includes: 1 Tub, 2 Large Dividers, 6 Medium Dividers, 3 Small Dividers



PREMIUM PROTECTION: PELICAN™+TREKPAK™

The TrekPak™ system uses pre-installed wall sections, divider panels, locking pins and a fool-proof cutting tool (included). Just lay your gear in the case, measure and cut the divider sections and lock them in place with the steel U-pins. We include extra divider material so you can change your mind, plus divider panels are also available separately so you can reconfigure your dividers anytime. Available in black cases only.





PELICAN
CASE CATALOG
**WATERTIGHT
PROTECTOR CASES**
CASE CATALOG
JUNE 2019

SINCE 1976





Dear Pelican Customer,

Our first Pelican™ Protector Case™ launched in 1978. Now, over 40 years later, Pelican Products, Inc. continues to lead the industry in the design and manufacture of the toughest and highest quality cases on the market.

Since joining Pelican, I have watched our teams take an already successful brand of go-to protective equipment cases and continuously innovate and expand upon them. In 2016 we introduced the Pelican™ Air case line, engineered to maintain the same standard of durability, but reduce the weight of each case by up to 40 percent. This relentless quest to offer Pelican users more versatility than ever before has been an unprecedented success for the company and we continue to release new sizes, colors and uses for the Pelican™ Air case line.

In response to customer feedback and demand, we made an addition to the line in 2019, the Pelican™ Air 1745 Case. This case is the longest Pelican™ Air case to be introduced, as well as the deepest of all Pelican long cases, boasting more than 5,900 square inches of interior space. The Pelican™ Air 1745 Case form factor was developed to protect all manners of equipment, including survey equipment, firearms, archery gear, and musical instruments, in the harshest environments.

Also added to the groundbreaking line is the Pelican™ Air 1465EMS Case, developed with first responders in mind. When every second counts, these professionals need a tough and lighter weight case with features such as a new three-tier, customizable, pull out tray system, Press and Pull latches that can survive great pressure, and a lid equipped with a polymer O-ring for a dust and water-resistant (IP66) seal.

Pelican continues to work tirelessly to innovate and improve our products and services. We would not be the global brand that we are today without the consistent support of our loyal customers. Thank you to all those who depend on Pelican for your equipment protection needs every day.

Lyndon Faulkner
Chief Executive Officer

MARKETS SERVED //

**FIRE
MILITARY
INDUSTRIAL
LAW ENFORCEMENT
OUTDOOR
CONSUMER
DIVE**



TABLE OF CONTENTS

- PELICAN™ AIR CASE SERIES 1
- NEW** ■ PELICAN™ PUC SERIES 5
- PELICAN™ PROTECTOR CASE™ SERIES 7
 - Memory Card & Micro Cases 9
 - Small Cases 11
 - Digital Survival Cases 12
 - Medium Cases 15
 - Large Cases 17
 - Long Cases 21
- PELICAN™ STORM CASE™ SERIES 23
 - Small Cases 25
 - Medium Cases 26
 - Large Cases 28
- CASE SPECIFICATIONS 31
- CASE INTERIOR SIZE COMPARISON 33
- SERVICES & ACCESSORIES 35



PELICAN™ AIR CASE SERIES

OUR LIGHTEST CASE WITH THE PROTECTION YOU NEED

At up to 40% lighter than other polymer cases, Pelican™ Air cases lighten the loads of the dedicated pros around the world who have set out to change the game.



PELICAN™ AIR CASE COLORS AVAILABLE

*Not available in all case sizes.



BLACK



SILVER



YELLOW



ORANGE



THE SCIENCE OF LIGHTNESS

Molded from the next generation of Pelican's lightweight HPX™ resin, a proprietary formula that rebounds without breaking, the honeycomb structural elements are actually stronger than solid polymer material.

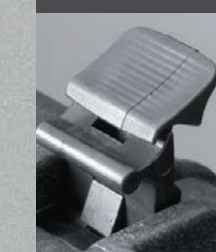

DOUBLE-THROW LATCHES

Double-Throw latches are smarter and easier to open: it's the classic 'C' clamp design with a secondary movement that works like a pry bar to start the release and offers plenty of leverage to open with a light pull.



WATERTIGHT

The secret is the tongue-and-groove fit with a polymer o-ring acting as a waterproof seal. Also, our Automatic Pressure Equalization Valve releases built-up air pressure while keeping water molecules out, resulting in a watertight case that is easy to open.



EASY RIDING

Stainless steel ball bearing wheels (on select cases) last longer and ride smoother. The nylon hub adjacent to the stainless steel resists heat resulting in less wear and tear on the polyurethane tire.



TESTED

The Pelican™ Protector Case™ design is the result of multiple generations of refinement. This evolution is proven through submergence and other lab tests.



1465

NEW

INTERNAL DIMS:
18.62" x 9.99" x 10.93"
(47.3 x 25.4 x 27.8 cm)

EXTERNAL DIMS:
20.83" x 12.62" x 12.75"
(52.9 x 32.1 x 32.4 cm)

■
Cat. No. 1465 **WF**
Cat. No. 1465**NF NF**



1465EMS

NEW

INTERNAL DIMS:
18.62" x 9.99" x 10.93"
(47.3 x 25.4 x 27.8 cm)

EXTERNAL DIMS:
20.83" x 12.62" x 12.75"
(52.9 x 32.1 x 32.4 cm)

■
Cat. No. 1465EMS
Case with custom configured
lid organizer and trays for EMS
professionals.



1485

INTERNAL DIMS:
17.75" x 10.18" x 6.15"
(45.1 x 25.9 x 15.6 cm)

EXTERNAL DIMS:
19.17" x 12.80" x 6.89"
(48.7 x 32.5 x 17.5 cm)

■ ■ ■ ■ ■
Cat. No. 1485 **WF**
Cat. No. 1485**NF NF**
Cat. No. 1485**WD WD**
Cat. No. 1485**TP TP**



1507

INTERNAL DIMS:
15.15" x 11.38" x 8.52"
(38.5 x 28.9 x 21.6 cm)

EXTERNAL DIMS:
16.87" x 14.10" x 9.27"
(42.8 x 35.8 x 23.5 cm)

■ ■ ■ ■ ■
Cat. No. 1507 **WF**
Cat. No. 1507**NF NF**
Cat. No. 1507**WD WD**
Cat. No. 1507**TP TP**



1525

INTERNAL DIMS:
20.50" x 11.31" x 6.75"
(52.1 x 28.7 x 17.1 cm)

EXTERNAL DIMS:
21.96" x 13.97" x 7.49"
(55.8 x 35.5 x 19 cm)

■ ■ ■ ■ ■
Cat. No. 1525 **WF**
Cat. No. 1525**NF NF**
Cat. No. 1525**WD WD**
Cat. No. 1525**TP TP**



1535 WHEELED CARRY-ON



INTERNAL DIMS:
20.39" x 11.20" x 7.21"
(51.8 x 28.4 x 18.3 cm)

EXTERNAL DIMS:
21.96" x 13.97" x 8.98"
(55.8 x 35.5 x 22.8 cm)

■ ■ ■ ■ ■
Cat. No. 1535 **WF**
Cat. No. 1535**NF NF**
Cat. No. 1535**WD WD**
Cat. No. 1535**TP TP**
Cat. No. 1535**TPF TPF**



ALSO AVAILABLE:
HYBRID INTERIOR
TREKPAK™ & PICK N PLUCK™

Check with airline for exact measurement requirements.

1555

INTERNAL DIMS:
23.00" x 12.75" x 7.50"
(58.4 x 32.4 x 19.1 cm)

EXTERNAL DIMS:
24.76" x 15.46" x 8.24"
(62.9 x 39.3 x 20.9 cm)

■ ■ ■ ■ ■
Cat. No. 1555 **WF**
Cat. No. 1555**NF NF**
Cat. No. 1555**WD WD**
Cat. No. 1555**TP TP**



1607



INTERNAL DIMS:
21.05" x 15.81" x 11.63"
(53.5 x 40.2 x 29.5 cm)

EXTERNAL DIMS:
24.13" x 18.80" x 13.25"
(61.3 x 47.8 x 33.7 cm)

■ ■ ■ ■ ■
Cat. No. 1607 **WF**
Cat. No. 1607**NF NF**
Cat. No. 1607**WD WD**



1745



NEW

INTERNAL DIMS:
44.01" x 16.77" x 7.94"
(111.8 x 42.6 x 20.2 cm)

EXTERNAL DIMS:
46.69" x 19.36" x 8.73"
(118.6 x 49.2 x 22.2 cm)

■
Cat. No. 1745 **WF**
Cat. No. 1745**NF NF**



1557

INTERNAL DIMS:
17.33" x 13.00" x 9.75"
(44.0 x 33.0 x 24.8 cm)

EXTERNAL DIMS:
19.18" x 15.79" x 10.50"
(48.7 x 40.1 x 26.7 cm)

■ ■ ■ ■ ■
Cat. No. 1557 **WF**
Cat. No. 1557**NF NF**
Cat. No. 1557**WD WD**
Cat. No. 1557**TP TP**



1615 WHEELED CHECK-IN



INTERNAL DIMS:
29.59" x 15.50" x 9.38"
(75.2 x 39.4 x 23.8 cm)

EXTERNAL DIMS:
32.58" x 18.40" x 11.02"
(82.8 x 46.7 x 28 cm)

■ ■ ■ ■ ■
Cat. No. 1615 **WF**
Cat. No. 1615**NF NF**
Cat. No. 1615**WD WD**
Cat. No. 1615**TP TP**



Check with airline for exact measurement requirements.

1745BOW



NEW

INTERNAL DIMS:
44.01" x 16.77" x 7.94"
(111.8 x 42.6 x 20.2 cm)

EXTERNAL DIMS:
46.69" x 19.36" x 8.73"
(118.6 x 49.2 x 22.2 cm)

■
Cat. No. 1745BOW
Case with custom configured
interior for bowhunters.
Bow and arrows not included.

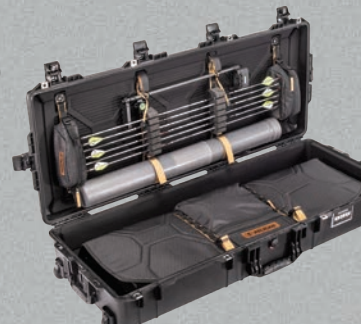

1605

INTERNAL DIMS:
26.00" x 14.00" x 8.38"
(66 x 35.6 x 21.3 cm)

EXTERNAL DIMS:
28.87" x 16.77" x 9.12"
(73.3 x 42.6 x 23.2 cm)

■ ■ ■ ■ ■
Cat. No. 1605 **WF**
Cat. No. 1605**NF NF**
Cat. No. 1605**WD WD**
Cat. No. 1605**TP TP**



1637

INTERNAL DIMS:
23.43" x 17.55" x 13.25"
(59.5 x 44.6 x 33.7 cm)

EXTERNAL DIMS:
26.61" x 20.65" x 14.87"
(67.6 x 52.5 x 37.8 cm)

■ ■ ■ ■ ■
Cat. No. 1637 **WF**
Cat. No. 1637**NF NF**
Cat. No. 1637**WD WD**



Icon indicates select models with wheels





PELICAN™ PERSONAL UTILITY CASE SERIES

PELICAN RUCK™ CASE

- OUTSIDE:**
- IP68 PROTECTION FROM DIRT, WATER, SNOW, DUST
 - RUBBER EXO-SKELETON
 - DUAL PIVOT LATCH
 - MULTIPLE EXTERNAL ATTACHMENT POINTS
- INSIDE:**
- SNAP IN, FLEXIBLE LID ORGANIZER
 - LOOP SYSTEM WITH VELCRO® BRAND STRAPS
 - CABLE ROUTING HOLE
 - RIGID DIVIDER TRAY



R20 PELICAN RUCK™ CASE

NEW

INTERNAL DIMS:
7.07" x 3.39" x 1.95"
(18 x 8.6 x 5 cm)

EXTERNAL DIMS:
8.96" x 4.83" x 2.88"
(22.8 x 12.3 x 7.3 cm)

■ ■ ■ ■
Cat. No. R20



R40 PELICAN RUCK™ CASE

NEW

INTERNAL DIMS:
7.63" x 4.70" x 1.90"
(19.4 x 11.9 x 4.8 cm)

EXTERNAL DIMS:
9.84" x 6.12" x 2.89"
(25 x 15.5 x 7.3 cm)

■ ■ ■ ■
Cat. No. R40



R60 PELICAN RUCK™ CASE

NEW

INTERNAL DIMS:
8.90" x 5.37" x 2.96"
(22.6 x 13.6 x 7.5 cm)

EXTERNAL DIMS:
11.14" x 6.86" x 3.88"
(28.3 x 17.4 x 9.9 cm)

■ ■ ■ ■
Cat. No. R60



PELICAN GO™ CASE

- OUTSIDE:**
- IP67 PROTECTION FROM DIRT, WATER, SNOW, DUST
 - RUBBERIZED PROTECTIVE BUMPER
 - SINGLE LATCH CLOSURE
 - EASY CARRY HANDLE
 - WATERTIGHT SEAL
- INSIDE:**
- ORGANIZING SYSTEM FOR CARDS (G40 ONLY)
 - CABLE ROUTING HOLE
 - RIGID DIVIDER TRAY

G10 PELICAN GO™ CASE

NEW

INTERNAL DIMS:
4.80" x 2.80" x 1.60"
(12.2 x 7.1 x 4.1 cm)

EXTERNAL DIMS:
7.05" x 4.37" x 1.81"
(17.9 x 11.1 x 4.6 cm)

■ ■ ■ ■ ■ ■ ■ ■
Cat. No. G10



G40 PELICAN GO™ CASE

NEW

INTERNAL DIMS:
7.00" x 3.50" x 1.60"
(17.8 x 8.9 x 4.1 cm)

EXTERNAL DIMS:
9.45" x 5.06" x 2.05"
(24 x 12.9 x 5.2 cm)

■ ■ ■ ■ ■ ■ ■ ■
Cat. No. G40





PELICAN™ PROTECTOR CASE™ SERIES

PROTECT WHAT MATTERS WITH MILITARY GRADE PROTECTION

No matter the job, the Pelican™ Protector Case™ is the standard in offering your equipment the protection it needs and deserves.



PELICAN™ PROTECTOR CASE™ COLORS AVAILABLE

*Not available in all case sizes.



SOLID CONSTRUCTION

The Pelican™ Protector Case™ uses an open cell core and solid wall construction, which is actually stronger and lighter than a solid core wall. Travel light with heavy protection.

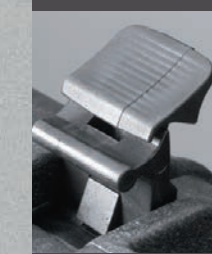

DOUBLE-THROW LATCHES

Double-Throw latches are smarter and easier to open: it's the classic 'C' clamp design with a secondary movement that works like a pry bar to start the release and offers plenty of leverage to open with a light pull.



WATERTIGHT

The secret is the tongue-and-groove fit with a polymer o-ring acting as a waterproof seal. Also, our Automatic Pressure Equalization Valve releases built-up air pressure while keeping water molecules out, resulting in a watertight case that is easy to open.



EASY RIDING

Stainless steel ball bearing wheels (on select cases) last longer and ride smoother. The nylon hub adjacent to the stainless steel resists heat resulting in less wear and tear on the polyurethane tire.



TESTED

The Pelican™ Case design is the result of multiple generations of refinement. This evolution is proven through submergence and other lab tests.

MEMORY CARD & MICRO CASES

From small sensitive components to smartphones, protect your gear from the elements in a Memory Card Case or Micro Case from Pelican.



0915 CASE

INTERNAL DIMS:
4.79" x 2.25" x 0.55"
(12.2 x 5.7 x 1.4cm)

EXTERNAL DIMS:
5.55" x 3.27" x 0.85"
(14.1 x 8.3 x 2.2cm)

Cat. No. 0915
Stores 12 SD cards or
6 mini SD cards and
6 micro SD cards.



0945 CASE

INTERNAL DIMS:
4.79" x 2.25" x 0.55"
(12.2 x 5.7 x 1.4 cm)

EXTERNAL DIMS:
5.55" x 3.27" x 0.85"
(14.1 x 8.3 x 2.2 cm)

Cat. No. 0945
Stores 6 compact
flash cards.



0955 CASE

INTERNAL DIMS:
4.79" x 2.25" x 0.55"
(12.2 x 5.7 x 1.4 cm)

EXTERNAL DIMS:
5.55" x 3.27" x 0.85"
(14.1 x 8.3 x 2.2cm)

Cat. No. 0955
Holds keys, ID,
cards and cash.



1010 MICRO CASE

INTERNAL DIMS:
4.37" x 2.87" x 1.68"
(11.1 x 7.3 x 4.3 cm)

EXTERNAL DIMS:
5.88" x 4.06" x 2.12"
(14.9 x 10.3 x 5.4 cm)

Cat. No. 1010
Available in clear with a colored rubber liner or
in solid colors with a black rubber liner. Pick N
Pluck™ foam inserts are available.



1020 MICRO CASE

INTERNAL DIMS:
5.31" x 3.56" x 1.68"
(13.5 x 9 x 4.3 cm)

EXTERNAL DIMS:
6.82" x 4.75" x 2.12"
(17.3 x 12.1 x 5.4 cm)

Cat. No. 1020
Available in clear with a colored
rubber liner or in solid colors with
a black rubber liner. Pick N Pluck™
foam inserts are available.



1040 MICRO CASE

INTERNAL DIMS:
6.50" x 3.87" x 1.75"
(16.5 x 9.8 x 4.4 cm)

EXTERNAL DIMS:
7.50" x 5.06" x 2.12"
(19.1 x 12.9 x 5.4 cm)

Cat. No. 1040
Available in clear with a colored
rubber liner or in solid colors with
a black rubber liner. Pick N Pluck™
foam inserts are available.



1015 MICRO CASE

INTERNAL DIMS:
5.14" x 2.64" x 1.37"
(13.1 x 6.7 x 3.5 cm)

EXTERNAL DIMS:
6.68" x 3.88" x 1.86"
(17 x 9.9 x 4.7 cm)

Cat. No. 1015
Available in clear with a colored
rubber liner or in solid colors with
a black rubber liner. Pick N Pluck™
foam inserts are available.



1030 MICRO CASE

INTERNAL DIMS:
6.37" x 2.62" x 2.06"
(16.2 x 6.7 x 5.2)

EXTERNAL DIMS:
7.50" x 3.87" x 2.43"
(19.1 x 9.8 x 6.2 cm)

Cat. No. 1030
Available in clear with a colored
rubber liner or in solid colors with
a black rubber liner. Pick N Pluck™
foam inserts are available.



1050 MICRO CASE

INTERNAL DIMS:
6.31" x 3.68" x 2.75"
(16 x 9.3 x 7 cm)

EXTERNAL DIMS:
7.50" x 5.06" x 3.12"
(19.1 x 12.9 x 7.9 cm)

Cat. No. 1050
Available in clear with a colored
rubber liner or in solid colors with
a black rubber liner. Pick N Pluck™
foam inserts are available.



1060 MICRO CASE

INTERNAL DIMS:
8.25" x 4.25" x 2.25"
(21 x 10.8 x 5.7 cm)

EXTERNAL DIMS:
9.37" x 5.56" x 2.62"
(23.8 x 14.1 x 6.7 cm)

Cat. No. 1060
Available in clear with a colored
rubber liner or in solid colors with
a black rubber liner. Pick N Pluck™
foam inserts are available.



SMALL CASES

Lightweight, but extremely strong; compact, yet fully capable. Perfect for valuable gear like hand tools and small to medium electronic components, hand held GPS systems, and DSLR cameras. All small cases are available empty or with pre-scored Pick N Pluck™ foam.



1120

INTERNAL DIMS:
7.29" x 4.78" x 3.33"
(18.5 x 12.1 x 8.5 cm)

EXTERNAL DIMS:
8.41" x 6.76" x 3.87"
(21.4 x 17.2 x 9.8 cm)



Cat. No. 1120 **WF**
Cat. No. 1120NF **NF**



1150

INTERNAL DIMS:
8.29" x 5.79" x 3.75"
(21.1 x 14.7 x 9.5 cm)

EXTERNAL DIMS:
9.44" x 7.80" x 4.29"
(24 x 19.8 x 10.9 cm)



Cat. No. 1150 **WF**
Cat. No. 1150NF **NF**



1170

INTERNAL DIMS:
10.54" x 6.04" x 3.16"
26.8 x 15.3 x 8 cm)

EXTERNAL DIMS:
11.64" x 8.34" x 3.78"
(29.6 x 21.2 x 9.6 cm)



Cat. No. 1170 **WF**
Cat. No. 1170NF **NF**



1200

INTERNAL DIMS:
9.25" x 7.12" x 4.12"
(23.5 x 18.1 x 10.5 cm)

EXTERNAL DIMS:
10.62" x 9.68" x 4.87"
(27 x 24.6 x 12.4 cm)



Cat. No. 1200 **WF**
Cat. No. 1200NF **NF**



1300

INTERNAL DIMS:
9.17" x 7.00" x 6.12"
(23.3 x 17.8 x 15.5 cm)

EXTERNAL DIMS:
10.62" x 9.68" x 6.87"
(27 x 24.6 x 17.4 cm)



Cat. No. 1300 **WF**
Cat. No. 1300NF **NF**



1400

INTERNAL DIMS:
11.81" x 8.87" x 5.18"
(30 x 22.5 x 13.2 cm)

EXTERNAL DIMS:
13.37" x 11.62" x 6.00"
(34 x 29.5 x 15.2 cm)



Cat. No. 1400 **WF**
Cat. No. 1400NF **NF**



DIGITAL SURVIVAL CASES

The ultimate in watertight, crushproof, and impact protected cases to transport your small electronics and other vital gear, anywhere on Earth. Digital survival cases provide the peace of mind and protection your laptops and tablets need.



1055CC

INTERNAL DIMS:
8.55" x 5.52" x 0.85"
(21.7 x 14 x 2.2 cm)

EXTERNAL DIMS:
9.42" x 7.02" x 1.24"
(23.9 x 17.8 x 3.1 cm)



Cat. No. 1055CC
† Designed to protect most 7" tablets and eReaders.



1065CC

INTERNAL DIMS:
9.96" x 7.76" x 0.81"
(25.3 x 19.7 x 2.1 cm)

EXTERNAL DIMS:
10.86" x 9.28" x 1.24"
(27.6 x 23.6 x 3.1 cm)



Cat. No. 1065CC
† Designed to protect most 10" tablets.



1070CC

INTERNAL DIMS:
12.80" x 8.95" x 0.72"
(32.5 x 22.7 x 1.8 cm)

EXTERNAL DIMS:
15.29" x 11.96" x 1.6"
(38.8 x 30.4 x 4.1 cm)



Cat. No. 1070CC
† Designed to fit 13" Ultrabook™ laptops.



1075

INTERNAL DIMS:
11.11" x 7.92" x 1.63"
(28.2 x 20.1 x 4.1 cm)

EXTERNAL DIMS:
12.38" x 9.75" x 2.13"
(31.4 x 24.8 x 5.4 cm)



*Cat. No. 1075 **WF**
† Designed to protect various electronic devices including external hard drives.



1075CC

INTERNAL DIMS:
11.11" x 7.92" x 1.63"
(28.2 x 20.1 x 4.1 cm)

EXTERNAL DIMS:
12.38" x 9.75" x 2.13"
(31.4 x 24.8 x 5.4 cm)



Cat. No. 1075CC
(with netbook liner)
† Designed to protect most popular netbooks up to 11.3" x 8.1" x 1.6"



† CHECK DEVICE DIMENSIONS TO ENSURE CORRECT CASE SIZE

P1075

INTERNAL DIMS:
11.11" x 7.92" x 1.63"
(28.2 x 20.1 x 4.1 cm)

EXTERNAL DIMS:
12.38" x 9.75" x 2.13"
(31.4 x 24.8 x 5.4 cm)



■ ***Cat. No. P1075 WF**
† Designed to fit pistols, revolvers and magazines.

1085

INTERNAL DIMS:
14.29" x 10.37" x 1.97"
(36.3 x 26.3 x 5 cm)

EXTERNAL DIMS:
15.64" x 12.41" x 2.50"
(39.7 x 31.5 x 6.4 cm)



■ ***Cat. No. 1085 WF**
† Designed to protect 14" laptops.

1085CC

INTERNAL DIMS:
14.29" x 10.37" x 1.97"
(36.3 x 26.3 x 5 cm)

EXTERNAL DIMS:
15.64" x 12.41" x 2.50"
(39.7 x 31.5 x 6.4 cm)



■ **Cat. No. 1085CC**
(with laptop liner)
† Designed to protect 14" laptops.

1495

INTERNAL DIMS:
18.87" x 13.12" x 3.81"
(47.9 x 33.3 x 9.7 cm)

EXTERNAL DIMS:
21.62" x 17.25" x 4.87"
(54.9 x 43.8 x 12.4 cm)



■ ■ **Cat. No. 1495 WF**
Cat. No. 1495NF NF

1495CC1

INTERNAL DIMS:
18.87" x 13.12" x 3.81"
(47.9 x 33.3 x 9.7 cm)

EXTERNAL DIMS:
21.62" x 17.25" x 4.87"
(54.9 x 43.8 x 12.4 cm)



■ ■ **Cat. No. 1495CC1**
Case with lid organizer, shock absorbing tray, nylon padded computer sleeve, accessories pouch, and removable shoulder strap.

1095

INTERNAL DIMS:
15.78" x 11.16" x 2.06"
(40.1 x 28.3 x 5.2 cm)

EXTERNAL DIMS:
17.18" x 13.24" x 2.60"
(43.6 x 33.6 x 6.6 cm)



■ ***Cat. No. 1095 WF**
† Designed to protect 15" laptops.

1095CC

INTERNAL DIMS:
15.78" x 11.16" x 2.06"
(40.1 x 28.3 x 5.2 cm)

EXTERNAL DIMS:
17.18" x 13.24" x 2.60"
(43.6 x 33.6 x 6.6 cm)



■ **Cat. No. 1095CC**
(with laptop liner)
† Designed to protect 15" laptops.

1470

INTERNAL DIMS:
15.70" x 10.70" x 3.87"
(39.9 x 27.2 x 9.8 cm)

EXTERNAL DIMS:
16.88" x 13.23" x 4.47"
(42.9 x 33.6 x 11.4 cm)



■ ■ **Cat. No. 1470 WF**
Cat. No. 1470NF NF

1495CC2

INTERNAL DIMS:
18.87" x 13.12" x 3.81"
(47.9 x 33.3 x 9.7 cm)

EXTERNAL DIMS:
21.62" x 17.25" x 4.87"
(54.9 x 43.8 x 12.4 cm)



■ ■ **Cat. No. 1495CC2**
Case with lid organizer, Pick N Pluck™ foam, and removable shoulder strap.

1430 TOP LOADER

INTERNAL DIMS:
13.56" x 5.76" x 11.70"
(34.4 x 14.6 x 29.7 cm)

EXTERNAL DIMS:
16.40" x 8.71" x 13.15"
(41.7 x 22.1 x 33.4 cm)



■ ■ ■ ■ ■ **Cat. No. 1430 WF**
Cat. No. 1430NF NF
Cat. No. 1434 (with padded divider and lid organizer)
Cat. No. 1437 (with padded office divider and lid organizer)

1490

INTERNAL DIMS:
17.75" x 11.37" x 4.12"
(45.1 x 28.9 x 10.5 cm)

EXTERNAL DIMS:
19.87" x 13.93" x 4.68"
(50.5 x 35.4 x 11.9 cm)



■ ■ **Cat. No. 1490 WF**
Cat. No. 1490NF NF

1490CC1

INTERNAL DIMS:
17.75" x 11.37" x 4.12"
(45.1 x 28.9 x 10.5 cm)

EXTERNAL DIMS:
19.87" x 13.93" x 4.68"
(50.4 x 35.4 x 11.9 cm)



■ ■ ■ **Cat. No. 1490CC1**
Case with lid organizer, fitted shock absorbing tray, and removable shoulder strap.

1490CC2

INTERNAL DIMS:
17.75" x 11.37" x 4.12"
(45.1 x 28.9 x 10.5 cm)

EXTERNAL DIMS:
19.87" x 13.93" x 4.68"
(50.5 x 35.4 x 11.9 cm)



■ ■ ■ **Cat. No. 1490CC2**
Case with lid organizer, Pick N Pluck™ foam, and removable shoulder strap.

1440 TOP LOADER

INTERNAL DIMS:
17.10" x 7.50" x 16.00"
(43.4 x 19.1 x 40.6 cm)

EXTERNAL DIMS:
19.70" x 12.00" x 18.00"
(50 x 30.5 x 45.7 cm)



■ ■ ■ ■ ■ **Cat. No. 1440 WF**
Cat. No. 1440NF NF
Cat. No. 1444 (with utility padded divider and lid organizer)
Cat. No. 1447 (with padded office divider and lid organizer)



MEDIUM CASES

Mobility with room for protecting larger gear or multiple instruments and accessories. Interior options are available for extra protection. Select models meet carry-on luggage specifications. Most cases are available empty, with foam, padded dividers or TrekPak™ dividers. See chart on page 31.



Icon indicates select models with wheels

1450

INTERNAL DIMS:
14.66" x 10.24" x 6.12"
(37.2 x 26 x 15.5 cm)

EXTERNAL DIMS:
16.44" x 13" x 6.82"
(41.8 x 33 x 17.3 cm)

■ ■ ■ ■ ■ *

Cat. No. 1450 WF
Cat. No. 1450NF NF
Cat. No. 1454 WD



1460

INTERNAL DIMS:
18.54" x 9.92" x 10.92"
(47.1 x 25.2 x 27.7cm)

EXTERNAL DIMS:
20.85" x 12.73" x 12.75"
(53 x 32.3 x 32.4 cm)

■ ■ ■ ■ *

Cat. No. 1460 WF
Cat. No. 1460NF NF
Cat. No. 1460AALG
Includes custom foam for 9430/9435.



1460 TOOL CASE

INTERNAL DIMS:
18.54" x 9.92" x 10.92"
(47.1 x 25.2 x 27.7cm)

EXTERNAL DIMS:
20.85" x 12.73" x 12.75"
(53 x 32.3 x 32.4 cm)

■ ■ ■ ■

Cat. No. 1460TOOL
Case with adjustable and removable tray dividers for easy customization.



1460 EMS

INTERNAL DIMS:
18.54" x 9.92" x 10.92"
(47.1 x 25.2 x 27.7 cm)

EXTERNAL DIMS:
20.85" x 12.73" x 12.75"
(53 x 32.3 x 32.4 cm)

■ ■ ■

Cat. No. 1460EMS
Case with custom configured lid organizer and trays for EMS professionals.



1500

INTERNAL DIMS:
16.75" x 11.18" x 6.12"
(42.5 x 28.4 x 15.5 cm)

EXTERNAL DIMS:
18.50" x 14.06" x 6.93"
(47 x 35.7 x 17.6 cm)

■ ■ ■ ■ ■ ■ *

Cat. No. 1500 WF
Cat. No. 1500NF NF
Cat. No. 1504 WD



1500 EMS

INTERNAL DIMS:
16.75" x 11.18" x 6.12"
(42.5 x 28.4 x 15.5 cm)

EXTERNAL DIMS:
18.50" x 14.06" x 6.93"
(47 x 35.7 x 17.6 cm)

■ ■ ■ ■

Cat. No. 1500EMS
Case with custom configured lid organizer and trays for EMS professionals.



1510 LOC

INTERNAL DIMS:
19.75" x 11.00" x 7.60"
(50.2 x 27.9 x 19.3 cm)

EXTERNAL DIMS:
22.00" x 13.81" x 9.00"
(55.9 x 35.1 x 22.9 cm)

■ ■ ■ ■ *

Cat. No. 1510LOC
Case with fully enclosed apparel insert, padded laptop sleeve, and accessory pouch.



1520

INTERNAL DIMS:
18.06" x 12.89" x 6.72"
(45.9 x 32.7 x 17.1 cm)

EXTERNAL DIMS:
19.78" x 15.77" x 7.41"
(50.2 x 40.1 x 18.8 cm)

■ ■ ■ ■ ■ ■ *

Cat. No. 1520 WF
Cat. No. 1520NF NF
Cat. No. 1524 WD
Cat. No. 1526
1520 Case with 1527 Convertible Travel Bag.



1510 WHEELED CARRY-ON

INTERNAL DIMS:
19.75" x 11.00" x 7.60"
(50.2 x 27.9 x 19.3 cm)

EXTERNAL DIMS:
22.00" x 13.81" x 9.00"
(55.9 x 35.1 x 22.9 cm)

■ ■ ■ ■ *

Cat. No. 1510 WF
Cat. No. 1510NF NF
Cat. No. 1514 WD
Cat. No. 1510TP TP
Cat. No. 1510TPF TPF
Check with airline for exact measurement requirements.



AVAILABLE:
HYBRID INTERIOR
TREKPAK™ & PICK N PLUCK™

1510 SC

INTERNAL DIMS:
19.75" x 11.00" x 7.60"
(50.2 x 27.9 x 19.3 cm)

EXTERNAL DIMS:
22.00" x 13.81" x 9.00"
(55.9 x 35.1 x 22.9 cm)

■ ■ ■ ■ *

Cat. No. 1510SC
Case with padded dividers, padded laptop sleeve, and accessory pouch.



1510M

INTERNAL DIMS:
19.75" x 11.00" x 7.60"
(50.2 x 27.9 x 19.3 cm)

EXTERNAL DIMS:
23.55" x 14.36" x 10.62"
(59.8 x 36.5 x 27 cm)

■

Cat. No. 1510M WF
Cat. No. 1510MNF NF
Mobility version features 2 oversized wheels for use on rough terrain.



1510 LFC

INTERNAL DIMS:
19.75" x 11.00" x 7.60"
(50.2 x 27.9 x 19.3 cm)

EXTERNAL DIMS:
22.00" x 13.81" x 9.00"
(55.9 x 35.1 x 22.9 cm)

■ ■ ■ ■ *

Cat. No. 1510LFC
Case with Pick N Pluck™ foam, padded laptop sleeve, and accessory pouch.



1550 EMS

INTERNAL DIMS:
18.43" x 14.00" x 7.62"
(46.8 x 35.6 x 19.4 cm)

EXTERNAL DIMS:
20.62" x 16.87" x 8.12"
(52.4 x 42.8 x 20.6 cm)

■ ■ ■ ■

Cat. No. 1550EMS
Case with custom configured lid organizer and trays for EMS professionals.



LARGE CASES

Designed for extreme protection during transport and storage. Customizable interiors allow for extra protection and inventory control. Select models feature retractable handles, extra wide grips and sturdy casters for efficient mobility.



Icon indicates select models with wheels



1560

INTERNAL DIMS:
19.92" x 14.98" x 9.00"
(50.6 x 38 x 22.9 cm)

EXTERNAL DIMS:
22.07" x 17.92" x 10.42"
(56.1 x 45.5 x 26.5 cm)



Cat. No. 1560 WF
Cat. No. 1560NF NF
Cat. No. 1564 WD
Cat. No. 1560TP TP



1560M

INTERNAL DIMS:
19.92" x 14.98" x 9.00"
(50.6 x 38 x 22.9 cm)

EXTERNAL DIMS:
23.78" x 18.33" x 12.08"
(60.4 x 46.6 x 30.7 cm)



Cat. No. 1560M WF
Cat. No. 1560MNF NF
Mobility version features 2 oversized wheels for use on rough terrain.



1560LOC

INTERNAL DIMS:
19.92" x 14.98" x 9.00"
(50.6 x 38 x 22.9 cm)

EXTERNAL DIMS:
22.07" x 17.92" x 10.42"
(56.1 x 45.5 x 26.5 cm)

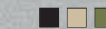

Cat. No. 1560LOC
Case with fully enclosed apparel insert, padded laptop sleeve, and accessory pouch.



1560SC

INTERNAL DIMS:
19.92" x 14.98" x 9.00"
(50.6 x 38 x 22.9 cm)

EXTERNAL DIMS:
22.07" x 17.92" x 10.42"
(56.1 x 45.5 x 26.5 cm)



Cat. No. 1560SC
Case with padded dividers, padded laptop sleeve, and accessory pouch.



1560LFC

INTERNAL DIMS:
19.92" x 14.98" x 9.00"
(50.6 x 38 x 22.9 cm)

EXTERNAL DIMS:
22.07" x 17.92" x 10.42"
(56.1 x 45.5 x 26.5 cm)



Cat. No. 1560LFC
Case with Pick N Pluck™ foam, padded laptop sleeve, and accessory pouch.



1600

INTERNAL DIMS:
21.51" x 16.54" x 7.99"
(54.6 x 42 x 20.3 cm)

EXTERNAL DIMS:
24.39" x 19.36" x 8.79"
(62 x 49.2 x 22.3 cm)



Cat. No. 1600 WF
Cat. No. 1600NF NF
Cat. No. 1604 WD
Cat. No. 1600TP TP



1600 EMS

INTERNAL DIMS:
21.51" x 16.54" x 7.99"
(54.6 x 42 x 20.3 cm)

EXTERNAL DIMS:
24.39" x 19.36" x 8.79"
(62 x 49.2 x 22.3 cm)



Cat. No. 1600EMS
Case with custom configured lid organizer and trays for EMS professionals.



1610

INTERNAL DIMS:
21.78" x 16.69" x 10.62"
(55.3 x 42.4 x 27 cm)

EXTERNAL DIMS:
24.83" x 19.69" x 11.88"
(63.1 x 50 x 30.2 cm)



Cat. No. 1610 WF
Cat. No. 1610NF NF
Cat. No. 1614 WD
Cat. No. 1610TP TP



1610M

INTERNAL DIMS:
21.78" x 16.69" x 10.62"
(55.3 x 42.4 x 27 cm)

EXTERNAL DIMS:
26.20" x 23.00" x 13.68"
(66.5 x 58.4 x 34.7 cm)



Cat. No. 1610M WF
Cat. No. 1610MNF NF
Mobility version features 2 oversized wheels for use on rough terrain.



1620

INTERNAL DIMS:
21.48" x 16.42" x 12.54"
(54.6 x 41.7 x 31.9 cm)

EXTERNAL DIMS:
24.76" x 19.57" x 13.90"
(62.9 x 49.7 x 35.3 cm)



Cat. No. **1620** WF
Cat. No. **1620NF** NF
Cat. No. **1624** WD



1620M

INTERNAL DIMS:
21.48" x 16.42" x 12.54"
(54.6 x 41.7 x 31.9 cm)

EXTERNAL DIMS:
26.20" x 23.00" x 15.61"
(66.5 x 58.4 x 39.6 cm)



Cat. No. **1620M** WF
Cat. No. **1620MNF** NF
Mobility version features 2 oversized wheels for use on rough terrain.



1630

INTERNAL DIMS:
27.70" x 20.98" x 15.50"
(70.4 x 53.3 x 39.4 cm)

EXTERNAL DIMS:
31.28" x 24.21" x 17.48"
(79.5 x 61.5 x 44.4 cm)

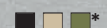

Cat. No. **1630** WF
Cat. No. **1630NF** NF
Cat. No. **1634** WD



1640

INTERNAL DIMS:
23.70" x 24.00" x 13.90"
(60.2 x 61 x 35.3 cm)

EXTERNAL DIMS:
27.20" x 27.50" x 16.30"
(69.1 x 69.9 x 41.4 cm)



Cat. No. **1640** WF
Cat. No. **1640NF** NF
Cat. No. **1644** WD



1650

INTERNAL DIMS:
28.57" x 17.52" x 10.65"
(72.6 x 44.5 x 27.1 cm)

EXTERNAL DIMS:
31.59" x 20.47" x 12.45"
(80.2 x 52 x 31.6 cm)



Cat. No. **1650** WF
Cat. No. **1650NF** NF
Cat. No. **1654** WD
Cat. No. **1650TP** TP



1660

INTERNAL DIMS:
28.20" x 19.66" x 17.63"
(71.6 x 49.9 x 44.8 cm)

EXTERNAL DIMS:
31.59" x 22.99" x 19.48"
(80.2 x 58.4 x 49.5 cm)



Cat. No. **1660** WF
Cat. No. **1660NF** NF
Cat. No. **1664** WD

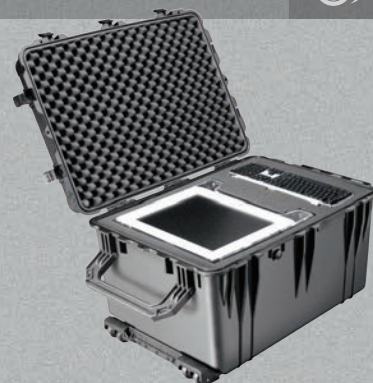

1670

INTERNAL DIMS:
28.10" x 16.49" x 9.19"
(71.4 x 41.9 x 23.3 cm)

EXTERNAL DIMS:
31.04" x 19.39" x 11.17"
(78.8 x 49.3 x 28.4 cm)



Cat. No. **1670** WF
Cat. No. **1674** WD
Mobility design features 4 extra-wide wheels and 2 extra-wide handles.



1690

INTERNAL DIMS:
30.13" x 25.13" x 15.36"
(76.5 x 63.8 x 39 cm)

EXTERNAL DIMS:
33.43" x 28.40" x 17.65"
(84.9 x 72.1 x 44.8 cm)



Cat. No. **1690** WF
Cat. No. **1690NF** NF
Cat. No. **1694** WD



1730

INTERNAL DIMS:
34.00" x 24.00" x 12.50"
(86.4 x 61 x 31.8 cm)

EXTERNAL DIMS:
37.05" x 27.20" x 14.37"
(94.1 x 69.1 x 36.5 cm)

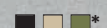

Cat. No. **1730** WF
Cat. No. **1730NF** NF



1780

INTERNAL DIMS:
41.12" x 21.54" x 14.88"
(104.4 x 54.7 x 37.8 cm)

EXTERNAL DIMS:
44.90" x 25.32" x 16.50"
(114 x 64.3 x 41.9 cm)

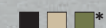

Cat. No. **1780** WF
Cat. No. **1780NF** NF



0340

INTERNAL DIMS:
18.00" x 18.00" x 18.00"
(45.7 x 45.7 x 45.7 cm)

EXTERNAL DIMS:
20.50" x 20.50" x 19.25"
(52.1 x 52.1 x 48.9 cm)



Cat. No. **0340** WF
Cat. No. **0340NF** NF
Cat. No. **0344** WD



0350

INTERNAL DIMS:
20.00" x 20.00" x 20.00"
(50.8 x 50.8 x 50.8 cm)

EXTERNAL DIMS:
22.50" x 22.43" x 21.25"
(57.2 x 57 x 54 cm)



Cat. No. **0350** WF
Cat. No. **0350NF** NF
Cat. No. **0354** WD



0370

INTERNAL DIMS:
24.00" x 24.00" x 24.00"
(61 x 61 x 61 cm)

EXTERNAL DIMS:
26.50" x 26.50" x 25.25"
(67.3 x 67.3 x 64.1 cm)



Cat. No. **0370** WF
Cat. No. **0370NF** NF
Cat. No. **0374** WD



0450

INTERNAL DIMS:
Varies by drawer configuration.

EXTERNAL DIMS:
23.95" x 14.75" x 17.95"
(60.8 x 37.5 x 45.6 cm)



Cat. No. **0450SD4**
(4 shallow + 2 deep drawers)
Cat. No. **0450SD6**
(6 shallow + 1 deep drawer)



0500

INTERNAL DIMS:
34.95" x 18.45" x 25.25"
(88.8 x 46.9 x 64.1 cm)

EXTERNAL DIMS:
39.95" x 23.45" x 28.65"
(101.5 x 59.6 x 72.8 cm)



Cat. No. **0500** WF
Cat. No. **0500NF** NF



0550

INTERNAL DIMS:
47.57" x 24.07" x 17.68"
(120.8 x 61.1 x 44.9 cm)

EXTERNAL DIMS:
51.05" x 27.54" x 22.79"
(129.7 x 70 x 57.9 cm)

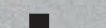

Cat. No. **0550** WF
Cat. No. **0550NF** NF



SHOWN WITH OPTIONAL CASTER WHEELS



LONG CASES

Ideal for weapons, but are also used by industrial workers for instruments and gear. Equipped with sturdy polyurethane wheels for ease of transport. All Long Cases are available empty or with solid foam (not Pick N Pluck™ foam). See chart on page 31.



Icon indicates select models with wheels



1700



INTERNAL DIMS:
35.75" x 13.50" x 5.25"
(90.8 x 34.3 x 13.3 cm)

EXTERNAL DIMS:
38.12" x 16.00" x 6.12"
(96.8 x 40.6 x 15.5 cm)

■ ■ ■ *

Cat. No. 1700 **WF**
Cat. No. 1700NF **NF**



1720



INTERNAL DIMS:
42.00" x 13.50" x 5.25"
(106.7 x 34.3 x 13.3 cm)

EXTERNAL DIMS:
44.37" x 16.00" x 6.12"
(112.7 x 40.6 x 15.5 cm)

■ ■ ■ *

Cat. No. 1720 **WF**
Cat. No. 1720NF **NF**



1740



INTERNAL DIMS:
40.98" x 12.92" x 12.13"
(104.1 x 32.8 x 30.8 cm)

EXTERNAL DIMS:
44.16" x 16.09" x 14.00"
(112.2 x 40.9 x 35.6 cm)

■ ■ ■ *

Cat. No. 1740 **WF**
Cat. No. 1740NF **NF**



1750



INTERNAL DIMS:
50.50" x 13.50" x 5.25"
(128.2 x 34.3 x 13.3 cm)

EXTERNAL DIMS:
53.00" x 16.00" x 6.12"
(134.6 x 40.6 x 15.5 cm)

■

Cat. No. 1750 **WF**
Cat. No. 1750NF **NF**



1770



INTERNAL DIMS:
54.58" x 15.58" x 8.63"
(138.6 x 39.6 x 21.9 cm)

EXTERNAL DIMS:
57.42" x 18.48" x 11.23"
(145.8 x 46.9 x 28.5 cm)

■ ■

Cat. No. 1770 **WF**
Cat. No. 1770NF **NF**



1780HL



INTERNAL DIMS:
41.12" x 21.54" x 14.88"
(104.4 x 54.7 x 37.8 cm)

EXTERNAL DIMS:
44.90" x 25.32" x 16.50"
(114 x 64.3 x 41.9 cm)

■ ■ ■ *

Cat. No. 1780HL
(rifle hard liner insert)
Cat. No. 1780RF
(rifle foam cut insert)





PELICAN™ STORM CASE™ SERIES

PROFESSIONAL-GRADE PROTECTION WITH EASY-TO-USE LATCHES

The Pelican™ Storm Case™ series combines our ultra sleek, professional-grade design with easy-to-use, self locking, Press and Pull latches for protection and convenience.



PELICAN™ STORM CASE™ COLORS AVAILABLE

*Not available in all case sizes.



BLACK



YELLOW



OD GREEN



PRESS AND PULL LATCHES

These smooth-opening, patented latches hold tight under pressure and impact with easy-opening performance. Tested to over 400 lbs., yet open with a simple release button.



MOLDED-IN LOCKABLE HASPS

Twin mating hasp holes on the rim of the case allow padlocks like Pelican's TSA approved cable padlock to keep your gear in and thieves out.



VORTEX® PRESSURE RELEASE VALVE

The automatic pressure release valve prevents vacuum lock, making it easy to open your case, even after extreme altitude changes. The microscopic filter blocks water molecules and dust particles so your gear stays clean.



RUGGED IN-LINE WHEELS

Shielded from dust, dirt and other contaminants – ball bearing wheels provide low-friction, low-drag rolling for easy movement of heavy loads.

*Select models only.



DOUBLE-LAYER, SOFT-GRIP HANDLES

When the weather goes south you'll find a secure grip that won't slip. An in-tool vulcanizing process over-molds the grips to the polymer handle for a lifetime of dependable performance.

SMALL CASES

Perfect for small gear and instruments, with all the features found in our larger cases: strong HPX™ resin construction, Vortex™ valve, and Press and Pull latches.



iM2050

INTERNAL DIMS:
9.50" x 7.50" x 4.25"
(24.1 x 19.1 x 10.8 cm)

EXTERNAL DIMS:
11.80" x 9.80" x 4.70"
(30 x 24.9 x 11.9 cm)



Cat. No. **iM2050** **WF**
Cat. No. **iM2050-X0000** **NF**
Cat. No. **iM2050-X0002** **WD**



iM2075

INTERNAL DIMS:
9.50" x 7.50" x 7.25"
(24.1 x 19.1 x 18.4 cm)

EXTERNAL DIMS:
11.80" x 9.80" x 7.70"
(30 x 24.9 x 19.6 cm)



Cat. No. **iM2075** **WF**
Cat. No. **iM2075-X0000** **NF**
Cat. No. **iM2075-X0002** **WD**



iM2100

INTERNAL DIMS:
13.00" x 9.20" x 6.00"
(33 x 23.4 x 15.2 cm)

EXTERNAL DIMS:
14.20" x 11.40" x 6.50"
(36.1 x 29 x 16.5 cm)



Cat. No. **iM2100** **WF**
Cat. No. **iM2100-X0000** **NF**
Cat. No. **iM2100-X0002** **WD**



MEDIUM CASES

From firefighters, EMTs, outdoor enthusiasts, and law enforcement to industrial engineers and photographers, there's a Pelican™ Storm Case™ for every professional. Built strong in four standard configurations: *TrekPak™ dividers, Pick N Pluck™ foam, *padded dividers, or empty. *Select models only.

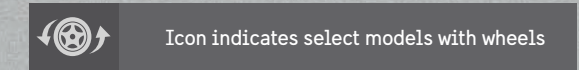

iM2200

INTERNAL DIMS:
15.00" x 10.50" x 6.00"
(38.1 x 26.7 x 15.2 cm)

EXTERNAL DIMS:
16.20" x 12.70" x 6.60"
(41.1 x 32.3 x 16.8cm)



Cat. No. **iM2200** **WF**
Cat. No. **iM2200-X0000** **NF**
Cat. No. **iM2200-X0002** **WD**



iM2300

INTERNAL DIMS:
17.00" x 11.70" x 6.20"
(43.2 x 29.7 x 15.7cm)

EXTERNAL DIMS:
18.20" x 13.9" x 6.70"
(46.2 x 35.3 x 17cm)



Cat. No. **iM2300** **WF**
Cat. No. **iM2300-X0000** **NF**
Cat. No. **iM2300-X0002** **WD**



iM2275

INTERNAL DIMS:
14.12" x 13.19" x 9.90"
(35.9 x 33.5 x 25.1 cm)

EXTERNAL DIMS:
15.25" x 15.50" x 10.22"
(38.7 x 39.4 x 26 cm)



Cat. No. **iM2275** **WF**
Cat. No. **iM2275-X0000** **NF**
Cat. No. **iM2275-X0002** **WD**
Cat. No. **iM2275-X0006** **TP**



iM2306

INTERNAL DIMS:
17.00" x 6.30" x 6.20"
(43.2 x 16 x 15.7cm)

EXTERNAL DIMS:
18.20" x 8.40" x 6.70"
(46.2 x 21.3 x 17cm)



Cat. No. **iM2306** **WF**
Cat. No. **iM2306-X0000** **NF**
Cat. No. **iM2306-X0002** **WD**



iM2370 LAPTOP CASE

INTERNAL DIMS:
18.20" x 12.10" x 5.20"
(46.2 x 30.7 x 13.2 cm)

EXTERNAL DIMS:
20.00" x 14.70" x 5.80"
(50.8 x 37.3 x 14.7 cm)



Cat. No. **iM2370** **WF**
Cat. No. **iM2370-X0000** **NF**
Cat. No. **iM2370-X0002** **WD**
Cat. No. **iM2370-X0003** (Computer Case Deluxe)



iM2400

INTERNAL DIMS:
18.00" x 13.00" x 6.70"
(45.7 x 33 x 17 cm)

EXTERNAL DIMS:
19.20" x 15.20" x 7.30"
(48.8 x 38.6 x 18.5 cm)



Cat. No. **iM2400** WF
Cat. No. **iM2400-X0000** NF
Cat. No. **iM2400-X0002** WD



iM2435



INTERNAL DIMS:
17.50" x 6.50" x 15.50"
(44.5 x 16.5 x 39.4 cm)

EXTERNAL DIMS:
18.63" x 9.25" x 16.50"
(47.3 x 23.5 x 41.9 cm)



Cat. No. **iM2435** WF
Cat. No. **iM2435-X0000** NF
Cat. No. **iM2435-X0002** WD
(includes lid organizer)



iM2450

INTERNAL DIMS:
18.00" x 13.00" x 8.40"
(45.7 x 33 x 21.3 cm)

EXTERNAL DIMS:
19.20" x 15.20" x 9.00"
(48.8 x 38.6 x 22.9 cm)



Cat. No. **iM2450** WF
Cat. No. **iM2450-X0000** NF
Cat. No. **iM2450-X0002** WD



iM2500



INTERNAL DIMS:
20.50" x 11.50" x 7.20"
(52.1 x 29.2 x 18.3 cm)

EXTERNAL DIMS:
21.70" x 14.10" x 8.90"
(55.1 x 35.8 x 22.6 cm)



Cat. No. **iM2500** WF
Cat. No. **iM2500-X0000** NF
Cat. No. **iM2500-X0002** WD
Cat. No. **iM2500-00006** TP



iM2600

INTERNAL DIMS:
20.00" x 14.00" x 7.70"
(50.8 x 35.6 x 19.6 cm)

EXTERNAL DIMS:
21.20" x 16.00" x 8.30"
(53.8 x 40.6 x 21.1 cm)



Cat. No. **iM2600** WF
Cat. No. **iM2600-X0000** NF
Cat. No. **iM2600-X0002** WD



iM2620



INTERNAL DIMS:
20.00" x 14.00" x 10.00"
(50.8 x 35.6 x 25.4 cm)

EXTERNAL DIMS:
21.20" x 16.00" x 10.60"
(53.8 x 40.6 x 26.9 cm)



Cat. No. **iM2620** WF
Cat. No. **iM2620-X0000** NF
Cat. No. **iM2620-X0002** WD
Cat. No. **iM2620-00006** TP



LARGE CASES

In the lab or out in the field, a large Pelican™ Storm Case™ with HPX™ resin construction stores and protects valuable and sensitive equipment from the elements. Pick N Pluck™ foam adds extra protection from shock during transport.



Icon indicates select models with wheels

iM2700

INTERNAL DIMS:
22.00" x 17.00" x 8.00"
(55.9 x 43.2 x 20.3 cm)

EXTERNAL DIMS:
24.60" x 19.70" x 8.60"
(62.5 x 50 x 21.8 cm)



Cat. No. **iM2700** WF
Cat. No. **iM2700-X0000** NF
Cat. No. **iM2700-X0002** WD



iM2720



INTERNAL DIMS:
22.00" x 17.00" x 10.00"
(55.9 x 43.2 x 25.4 cm)

EXTERNAL DIMS:
24.60" x 19.70" x 11.70"
(62.5 x 50 x 29.7 cm)



Cat. No. **iM2720** WF
Cat. No. **iM2720-X0000** NF
Cat. No. **iM2720-X0002** WD
Cat. No. **iM2720-00006** TP



iM2750



INTERNAL DIMS:
22.00" x 17.00" x 12.70"
(55.9 x 43.2 x 32.2 cm)

EXTERNAL DIMS:
24.60" x 19.70" x 14.40"
(62.5 x 50 x 36.6 cm)



Cat. No. **iM2750** WF
Cat. No. **iM2750-X0000** NF
Cat. No. **iM2750-X0002** WD



iM2875



INTERNAL DIMS:
22.50" x 21.10" x 11.40"
(57.2 x 53.6 x 29 cm)

EXTERNAL DIMS:
24.90" x 23.70" x 13.10"
(63.2 x 60.2 x 33.3 cm)



Cat. No. **iM2870** WF
Cat. No. **iM2870-X0000** NF
Cat. No. **iM2870-X0002** WD



iM2950



INTERNAL DIMS:
29.00" x 18.00" x 10.50"
(73.7 x 45.7 x 26.7 cm)

EXTERNAL DIMS:
31.30" x 20.40" x 12.20"
(79.5 x 51.8 x 31 cm)



Cat. No. **iM2950** WF
Cat. No. **iM2950-X0000** NF
Cat. No. **iM2950-X0002** WD
Cat. No. **iM2950-00006** TP



iM2975



INTERNAL DIMS:
29.00" x 18.00" x 13.80"
(73.7 x 45.7 x 35.1 cm)

EXTERNAL DIMS:
31.30" x 20.40" x 15.50"
(79.5 x 51.8 x 39.4 cm)



Cat. No. **iM2975** **WF**
Cat. No. **iM2975-X0000** **NF**
Cat. No. **iM2975-X0002** **WD**

iM3075



INTERNAL DIMS:
29.80" x 20.80" x 17.80"
(75.7 x 52.8 x 45.2 cm)

EXTERNAL DIMS:
33.30" x 24.40" x 19.30"
(84.6 x 62 x 49 cm)



Cat. No. **iM3075** **WF**
Cat. No. **iM3075-X0000** **NF**
Cat. No. **iM3075-X0002** **WD**

iM3100



INTERNAL DIMS:
36.50" x 14.00" x 6.00"
(92.7 x 35.6 x 15.2 cm)

EXTERNAL DIMS:
39.80" x 16.50" x 6.70"
(101.1 x 41.9 x 17 cm)



Cat. No. **iM3100** **WF**
Cat. No. **iM3100-X0000** **NF**

iM3200



INTERNAL DIMS:
44.00" x 14.00" x 6.00"
(111.8 x 35.6 x 15.2 cm)

EXTERNAL DIMS:
47.20" x 16.50" x 6.70"
(119.9 x 41.9 x 17 cm)



Cat. No. **iM3200** **WF**
Cat. No. **iM3200-X0000** **NF**

iM3220



INTERNAL DIMS:
44.00" x 14.00" x 8.50"
(111.8 x 35.6 x 21.6 cm)

EXTERNAL DIMS:
47.20" x 16.50" x 9.20"
(119.9 x 41.9 x 23.4 cm)



Cat. No. **iM3220** **WF**
Cat. No. **iM3220-X0000** **NF**

iM3300



INTERNAL DIMS:
50.50" x 14.00" x 6.00"
(128.3 x 35.6 x 15.2 cm)

EXTERNAL DIMS:
53.80" x 16.50" x 6.70"
(136.7 x 41.9 x 17 cm)



Cat. No. **iM3300** **WF**
Cat. No. **iM3300-X0000** **NF**

iM3300RFL



INTERNAL DIMS:
50.50" x 14.00" x 6.00"
(128.3 x 35.6 x 15.2 cm)

EXTERNAL DIMS:
53.80" x 16.50" x 6.70"
(136.7 x 41.9 x 17 cm)



Cat. No. **iM3300RFL** **WF**

iM3300SGN



INTERNAL DIMS:
50.50" x 14.00" x 6.00"
(128.3 x 35.6 x 15.2 cm)

EXTERNAL DIMS:
53.80" x 16.50" x 6.70"
(136.7 x 41.9 x 17 cm)



Cat. No. **iM3300SGN** **WF**

iM3410



INTERNAL DIMS:
54.50" x 10.00" x 6.00"
(138.4 x 25.4 x 15.2 cm)

EXTERNAL DIMS:
57.74" x 12.71" x 6.67"
(146.7 x 32.3 x 16.9 cm)





Cat. No. **iM3410** **WF**
Cat. No. **iM3410-X0000** **NF**



CASE INTERIOR SIZE COMPARISON

Interior size comparison chart features the smallest case size [top] to largest case size [bottom], based on interior volume size.

 PELICAN™ PROTECTOR CASE™
  PELICAN™ AIR CASE
  PELICAN™ STORM CASE™

CAT. NO.	INTERIOR DIMENSIONS		WEIGHT	
	inches	centimeters	lbs	kg
1120 PROTECTOR	7.29" x 4.78" x 3.33"	(18.5 x 12.1 x 8.5)	1.34	0.608
1150 PROTECTOR	8.29" x 5.79" x 3.75"	(21.1 x 14.7 x 9.5)	1.61	0.730
1170 PROTECTOR	10.54" x 6.04" x 3.16"	(26.8 x 15.3 x 8)	1.96	0.889
1200 PROTECTOR	9.25" x 7.12" x 4.12"	(23.5 x 18.1 x 10.5)	2.65	1.202
IM2050 STORM	9.5" x 7.5" x 4.25"	(24.1 x 19.1 x 10.8)	2.7	1.225
1300 PROTECTOR	9.17" x 7" x 6.12"	(23.3 x 17.8 x 15.5)	3.09	1.402
IM2075 STORM	9.5" x 7.5" x 7.25"	(24.1 x 19.1 x 18.4)	3.3	1.497
1400 PROTECTOR	11.81" x 8.87" x 5.18"	(30 x 22.5 x 13.2)	3.97	1.801
1470 PROTECTOR	15.7" x 10.7" x 3.87"	(39.9 x 27.2 x 9.8)	4.28	1.941
IM2306 STORM	17" x 6.3" x 6.2"	(43.2 x 16 x 15.7)	4.3	1.950
IM2100 STORM	13" x 9.2" x 6"	(33 x 23.4 x 15.2)	4.2	1.905
1490 PROTECTOR	17.75" x 11.37" x 4.12"	(45.1 x 28.9 x 10.5)	5.47	2.481
1450 PROTECTOR	14.66" x 10.24" x 6.12"	(37.2 x 26 x 15.5)	5.51	2.499
1495 PROTECTOR	18.87" x 13.12" x 3.81"	(47.9 x 33.3 x 9.7)	7.23	3.279
IM2200 STORM	15" x 10.5" x 6"	(38.1 x 26.7 x 15.2)	4.9	2.223
1485 AIR	17.75" x 10.18" x 6.15"	(45.1 x 25.9 x 15.6)	4.57	2.073
IM2370 STORM	18.2" x 12.1" x 5.2"	(46.2 x 30.7 x 13.2)	5.7	2.585
1500 PROTECTOR	16.75" x 11.18" x 6.12"	(42.5 x 28.4 x 15.5)	7.13	3.234
IM2300 STORM	17" x 11.7" x 6.2"	(43.2 x 29.7 x 15.7)	5.9	2.676
1507 AIR	15.15" x 11.38" x 8.52"	(38.5 x 28.9 x 21.6)	5.24	2.377
1520 PROTECTOR	18.06" x 12.89" x 6.72"	(45.9 x 32.7 x 17.1)	8.29	3.760
1525 AIR	20.5" x 11.31" x 6.75"	(52.1 x 28.7 x 17.1)	5.99	2.717
IM2400 STORM	18" x 13" x 6.7"	(45.7 x 33 x 17)	6.5	2.948
1535 AIR	20.39" x 11.2" x 7.21"	(51.8 x 28.4 x 18.3)	8.69	3.942
1510 PROTECTOR	19.75" x 11" x 7.6"	(50.2 x 27.9 x 19.3)	11.99	5.439
IM2500 STORM	20.5" x 11.5" x 7.2"	(52.1 x 29.2 x 18.3)	11.1	5.035
IM2435 STORM	17.5" x 6.5" x 15.5"	(44.5 x 16.5 x 39.4)	10	4.536
IM2275 STORM	14.12" x 13.19" x 9.9"	(35.9 x 33.5 x 25.1)	8	3.629
IM2450 STORM	18" x 13" x 8.4"	(45.7 x 33 x 21.3)	7.4	3.357
1460 PROTECTOR	18.54" x 9.92" x 10.92"	(47.1 x 25.2 x 27.7)	8.75	3.969
1466 AIR	18.62" x 9.99" x 10.93"	(47.3 x 25.4 x 27.8)	7.12	3.230
1550 PROTECTOR	18.63" x 14.18" x 7.72"	(47.3 x 36 x 19.6)	10.58	4.799
IM2600 STORM	20" x 14" x 7.7"	(50.8 x 35.6 x 19.6)	8.5	3.856
1557 AIR	17.33" x 13" x 9.75"	(44 x 33 x 24.8)	6.6	2.994
1556 AIR	23" x 12.75" x 7.5"	(58.4 x 32.4 x 19.1)	7.37	3.343
1700 PROTECTOR	35.75" x 13.5" x 5.25"	(90.8 x 34.3 x 13.3)	16.09	7.298

CAT. NO.	INTERIOR DIMENSIONS		WEIGHT	
	inches	centimeters	lbs	kg
1560 PROTECTOR	19.92" x 14.98" x 9"	(50.6 x 38 x 22.9)	17	7.711
0340 PROTECTOR	18" x 18" x 18"	(45.7 x 45.7 x 45.7)	24	10.886
IM2620 STORM	20" x 14" x 10"	(50.8 x 35.6 x 25.4)	12.5	5.670
1600 PROTECTOR	21.51" x 16.54" x 7.99"	(54.6 x 42 x 20.3)	13	5.897
0450 PROTECTOR	20.56" x 10.97" x 12.65"	(52.2 x 27.9 x 32.1)	41.50	18.8
1720 PROTECTOR	42" x 13.5" x 5.25"	(106.7 x 34.3 x 13.3)	16.76	7.602
IM2700 STORM	22" x 17" x 8"	(55.9 x 43.2 x 20.3)	11.1	5.035
1605 AIR	26" x 14" x 8.38"	(66 x 35.6 x 21.3)	9.28	4.209
IM3100 STORM	36.5" x 14" x 6"	(92.7 x 35.6 x 15.2)	15.2	6.895
IM3410 STORM	54.5" x 10" x 6"	(138.4 x 25.4 x 15.2)	18	8.165
1750 PROTECTOR	50.5" x 13.5" x 5.25"	(128.3 x 34.3 x 13.3)	23.59	10.700
IM3200 STORM	44" x 14" x 6"	(111.8 x 35.6 x 15.2)	17.7	8.029
IM2720 STORM	22" x 17" x 10"	(55.9 x 43.2 x 25.4)	16.8	7.620
1610 PROTECTOR	21.78" x 16.69" x 10.62"	(55.3 x 42.4 x 27)	19.5	8.845
1607 AIR	21.05" x 15.81" x 11.63"	(53.5 x 40.2 x 29.5)	13.2	5.987
IM3300 STORM	50.5" x 14" x 6"	(128.3 x 35.6 x 15.2)	19.1	8.664
1670 PROTECTOR	28.1" x 16.49" x 9.19"	(71.4 x 41.9 x 23.3)	23	10.433
1615 AIR	29.59" x 15.5" x 9.38"	(75.2 x 39.4 x 23.8)	14.06	6.378
1620 PROTECTOR	21.48" x 16.42" x 12.54"	(54.6 x 41.7 x 31.9)	21.20	9.6
IM2750 STORM	22" x 17" x 12.7"	(55.9 x 43.2 x 32.3)	18.5	8.391
IM3220 STORM	44" x 14" x 8.5"	(111.8 x 35.6 x 21.6)	20.4	9.253
1650 PROTECTOR	28.57" x 17.52" x 10.65"	(72.6 x 44.5 x 27.1)	24.03	10.900
IM2875 STORM	22.5" x 21.1" x 11.4"	(57.2 x 53.6 x 29)	20.1	9.117
1637 AIR	23.43" x 17.55" x 13.25"	(59.5 x 44.6 x 33.7)	15.2	6.895
IM2950 STORM	29" x 18" x 10.5"	(73.7 x 45.7 x 26.7)	20.8	9.435
0340 PROTECTOR	18.00" x 18.00" x 18.00"	(45.7 x 45.7 x 45.7)	24	10.9
1745 AIR	44" x 16.77" x 8"	(111.8 x 42.6 x 20.3)	17.26	7.829
1740 PROTECTOR	40.98" x 12.92" x 12.13"	(104.1 x 32.8 x 30.8)	22	9.979
IM2975 STORM	29" x 18" x 13.8"	(73.7 x 45.7 x 35.1)	22.8	10.342
1770 PROTECTOR	54.58" x 15.58" x 8.63"	(138.6 x 39.6 x 21.9)	29	13.154
1640 PROTECTOR	23.7" x 24" x 13.9"	(60.2 x 61 x 35.3)	34	15.422
0350 PROTECTOR	20" x 20" x 20"	(50.8 x 50.8 x 50.8)	25.99	11.789
1630 PROTECTOR	27.7" x 20.98" x 15.5"	(70.4 x 53.3 x 39.4)	31	14.061
1660 PROTECTOR	28.2" x 19.66" x 17.63"	(71.6 x 49.9 x 44.8)	34.16	15.495
1730 PROTECTOR	34" x 24" x 12.5"	(86.4 x 61 x 31.8)	30	13.608
IM3075 STORM	29.8" x 20.8" x 17.8"	(75.7 x 52.8 x 45.2)	31.5	14.288
1690 PROTECTOR	30.13" x 25.13" x 15.36"	(76.5 x 63.8 x 39)	34	15.422
1780 PROTECTOR	41.12" x 21.54" x 14.88"	(104.4 x 54.7 x 37.8)	38.4	17.418
0370 PROTECTOR	24" x 24" x 24"	(61 x 61 x 61)	31.97	14.501
0500 PROTECTOR	34.95" x 18.45" x 25.25"	(88.8 x 46.9 x 64.1)	50	22.680
0550 PROTECTOR	47.57" x 24.07" x 17.68"	(120.8 x 61.1 x 44.9)	79.2	35.925



SERVICES & ACCESSORIES



SHOULDER STRAP

Heavy-duty shoulder strap offers comfort and support.

THINK INSIDE AND OUTSIDE THE BOX

The exterior protection of your hard case is only half the story and, with interior customization and accessory options, you get 360° of protection and organization solutions.

Inside the Box interior case solutions offer you multiple organization options. Choose from our TrekPak™ divider system, padded dividers, or Pick N Pluck™ foam for the organization your equipment deserves.

Custom case solutions make protecting complex equipment easy. With options like custom engineered deck mount suspension systems and specialized foam options, your equipment stays organized and protected from extreme G-forces.

Pelican also offers a wide range of accessories including custom nameplates, caster wheels, shoulder straps, and TSA locks, making it easier to travel with and transport your gear without concern.

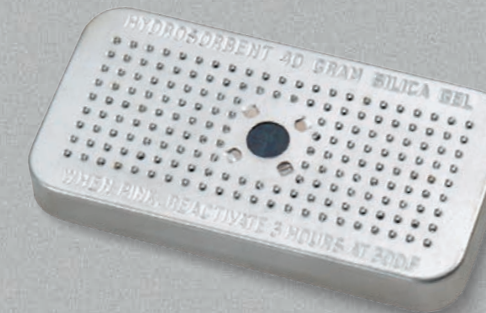

PELI DESICCANT (SILICA GEL)

Absorbs moisture and prevents condensation from forming inside a case in high-humidity climates.



TSA LOCKS

TSA-accepted locks keep thieves out, while allowing TSA necessary access.



CARD HOLDER

Removeable card holders are ideal for shipping documents and identification cards.



LID ORGANIZER

Zippered mesh pockets keep your smaller equipment organized.



NAMEPLATES

Custom order nameplates to make it easier to identify your case.



PALLET RISERS

Pallet risers raise the level of a case to allow forklift forks to slide under.



CASTER WHEEL KITS

Detachable caster wheels can be attached for easier transport and detached for storage.



LID STAYS

Lid stays lock your lid in place to allow access to your equipment without the worry of accidental lid closure.

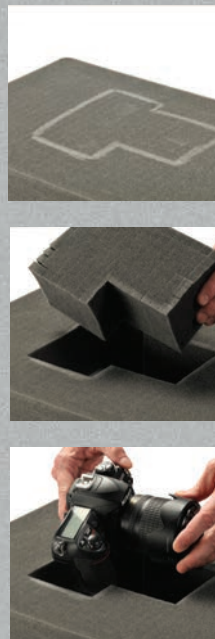

PICK N PLUCK™ FOAM

An easy, do-it-yourself system for the interior of the case. Layers of foam are pre-scored in 1/2" or 1" cubes. Simply lay your equipment on the foam, tape or chalk to mark the foam, and pluck away. Always allow at least one inch of foam between your equipment and the wall of the case.

We offer replacement foam Just enter the case catalog number in the search field to view available foam sets.

Solid foam (which can be cut with an electric knife or coping saw) is preferred for oversize items such as long guns. The following cases ship with solid foam instead of Pick N Pluck™ Foam: 1700, 1720, 1740, 1750, 1770, iM3100, iM3200, iM3220, iM3300, iM3410



TREKPAK™ DIVIDER & PICK N PLUCK™ FOAM HYBRID INTERIOR

With two NEW Pelican™ Hybrid interiors, organization has been taken to the next level. TrekPak™ dividers and Pick N Pluck™ foam have been combined in two of our most popular cases, the Pelican™ 1510 Protector Case™ and the Pelican™ 1535 Air case. This combination allows for unlimited options to keep your equipment intact, organized and ready to go.

Pick N Pluck™ foam is perfect for fixed solutions and TrekPak™ dividers give you the freedom to adjust the case to your ever-changing accessory needs.

Hybrid configuration available for 1510 (Cat No.1510TPF) and 1535 Air (Cat No.1535TPF)



TREKPAK™ DIVIDER SYSTEM

Now available in our most popular case sizes, our TrekPak™ Divider System is a versatile kit that allows you to organize your case like a pro. Durable, closed-cell foam is laminated to corrugated panels that provide a precise grid of protection without wasting any space.

The TrekPak™ Divider System comes complete with perimeter wall sections installed, divider panels, locking pins and a fool-proof cutting tool. Extra divider material is included and available separately so you can reconfigure your case anytime.



Available in our most popular Pelican™ Protector Case™, Pelican™ Storm Case™, and Pelican™ Air Case sizes. TrekPak™ Divider System also sold separately.



PADDED DIVIDERS

A classic organizational solution. Versatile and durable, padded dividers easily adjust to fit your equipment into any configuration on the fly. Plus, you can quickly identify your gear with the padded divider's high contrast color.

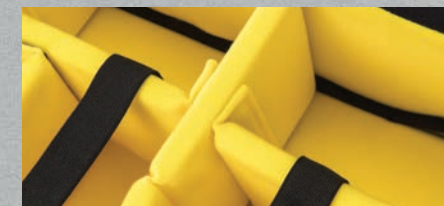

Padded Divider Walls are covered with mountable fabric, providing endless reconfigurations



- O-ring
- Panel Frame/Bezel Kit
- Attachment Hardware

PANEL FRAME AND BEZEL KITS

Many Pelican™ cases can be adapted for use with electronic interface panels by using a Panel Frame (Pelican™ Protector Case™) or Bezel Kit (Pelican™ Storm Case™) accessory. Mount most interface panels (customer supplied) flush with the rim of the Pelican™ Protector Case™ or desired area in a Pelican™ Storm Case™, and your technology is ready to go.

A polymer o-ring seals the panel so the base of the case remains watertight, even with the lid open. The mounting bracket, fasteners and o-ring are included in the Panel Frame Kit.

PELICAN™ PROTECTOR CASE™ WITH PANEL FRAME AVAILABILITY				
CAT. NO.	INTERIOR DIMENSIONS		EXTERIOR DIMENSIONS	
	inches/cm	LxWxH	inches/cm	LxWxH
1120	7.29" x 4.78" x 3.33" (18.5 x 12.1 x 8.5 cm)		8.41" x 6.76" x 3.87" (21.4 x 17.2 x 9.8 cm)	
1150	8.29" x 5.79" x 3.75" (21.1 x 14.7 x 9.5 cm)		9.44" x 7.80" x 4.29" (24 x 19.8 x 10.9 cm)	
1200	9.25" x 7.12" x 4.12" (23.5 x 18.1 x 10.5 cm)		10.62" x 9.68" x 4.87" (27 x 24.6 x 12.4 cm)	
1300	9.17" x 7.00" x 6.12" (23.3 x 17.8 x 15.5 cm)		10.62" x 9.68" x 6.87" (27 x 24.6 x 17.4 cm)	
1400	11.81" x 8.87" x 5.18" (30 x 22.5 x 13.2 cm)		13.37" x 11.62" x 6.00" (34 x 29.5 x 15.2 cm)w	
1430	13.56" x 5.76" x 11.70" (34.4 x 14.6 x 29.7 cm)		16.40" x 8.71" x 13.15" (41.7 x 22.1 x 33.4 cm)	
1450	14.66" x 10.24" x 6.12" (37.2 x 26 x 15.5 cm)		16.44" x 13" x 6.82" (41.8 x 33 x 17.3 cm)	
1470	15.70" x 10.70" x 3.87" (39.9 x 27.2 x 9.8 cm)		16.88" x 13.23" x 4.47" (42.9 x 33.6 x 11.4 cm)	
1490	17.75" x 11.37" x 4.12" (45.1 x 28.9 x 10.5 cm)		19.87" x 13.93" x 4.68" (50.5 x 35.4 x 11.9 cm)	
1500	16.75" x 11.18" x 6.12" (42.5 x 28.4 x 15.5 cm)		18.50" x 14.06" x 6.93" (47 x 35.7 x 17.6 cm)	
1520	18.06" x 12.89" x 6.72" (45.9 x 32.7 x 17.1 cm)		19.78" x 15.77" x 7.41" (50.2 x 40.1 x 18.8 cm)	
1550	18.63" x 14.18" x 7.72" (47.3 x 36 x 19.6 cm)		20.66" x 17.20" x 8.40" (52.5 x 43.7 x 21.3 cm)	

⚠ WARNING: This product can expose you to chemicals including Lead and lead compounds, which are known to the State of California to cause cancer and birth defects or other reproductive harm. For more information go to www.P65Warnings.ca.gov.

PELICAN™ STORM CASE™ WITH BEZEL KIT AVAILABILITY				
CAT. NO.	INTERIOR DIMENSIONS		EXTERIOR DIMENSIONS	
	inches/cm	LxWxH	inches/cm	LxWxH
iM2050	9.5" x 7.5" x 4.25" (24.1 x 19.1 x 10.8 cm)		11.8" x 9.8" x 4.7" (30 x 24.9 x 11.9 cm)	
iM2075	9.5" x 7.5" x 7.25" (24.1 x 19.1 x 18.4 cm)		11.8" x 9.8" x 7.7" (30 x 24.9 x 19.6 cm)	
iM2100	13" x 9.2" x 6" (33 x 23.4 x 15.2 cm)		14.2" x 11.4" x 6.5" (36.1 x 29 x 16.5 cm)	
iM2200	15" x 10.5" x 6" (38.1 x 26.7 x 15.2 cm)		16.2" x 12.7" x 6.6" (41.1 x 32.3 x 16.8 cm)	
iM2300	17" x 11.7" x 6.2" (43.2 x 29.7 x 15.7 cm)		18.2" x 13.9" x 6.7" (46.2 x 35.3 x 17 cm)	
iM2306	17" x 6.3" x 6.2" (43.2 x 16 x 15.7 cm)		18.2" x 8.4" x 6.7" (46.2 x 21.3 x 17 cm)	
iM2370	18.2" x 12.1" x 5.2" (46.2 x 30.7 x 13.2 cm)		20" x 14.7" x 5.8" (50.8 x 37.3 x 14.7 cm)	
iM2400	18" x 13" x 6.7" (45.7 x 33 x 17 cm)		19.2" x 15.2" x 7.3" (48.8 x 38.6 x 18.5 cm)	
iM2450	18" x 13" x 8.4" (45.7 x 33 x 21.3 cm)		19.2" x 15.2" x 9" (48.8 x 38.6 x 22.9 cm)	
iM2500	20.5" x 11.5" x 7.2" (52.1 x 29.2 x 18.3 cm)		21.7" x 14.1" x 8.9" (55.1 x 35.8 x 22.6 cm)	
iM2600	20" x 14" x 7.7" (50.8 x 35.6 x 19.6 cm)		21.2" x 16" x 8.3" (53.8 x 40.6 x 21.1 cm)	
iM2620	20" x 14" x 10" (50.8 x 35.6 x 25.4 cm)		21.2" x 16" x 10.6" (53.8 x 40.6 x 26.9 cm)	
iM2700	22" x 17" x 8" (55.9 x 43.2 x 20.3 cm)		24.6" x 19.7" x 8.6" (62.5 x 50 x 21.8 cm)	
iM2720	22" x 17" x 10" (55.9 x 43.2 x 25.4 cm)		24.6" x 19.7" x 11.7" (62.5 x 50 x 29.7 cm)	
iM2750	22" x 17" x 12.7" (55.9 x 43.2 x 32.2 cm)		24.6" x 19.7" x 14.4" (62.5 x 50 x 36.6 cm)	
iM2875	22.5" x 21.1" x 11.4" (57.2 x 53.6 x 29 cm)		24.9" x 23.7" x 13.1" (63.2 x 60.2 x 33.3 cm)	
iM2950	29" x 18" x 10.5" (73.7 x 45.7 x 26.7 cm)		31.3" x 20.4" x 12.2" (79.5 x 51.8 x 31 cm)	
iM2975	29" x 18" x 13.8" (73.7 x 45.7 x 35.1 cm)		31.3" x 20.4" x 15.5" (79.5 x 51.8 x 39.4 cm)	



LID ORGANIZERS

Made of simulated leather or ballistic nylon with nylon zippers. A wide variety of pocket sizes protect and keep your gear organized. They install easily with Velcro® strips (included).



PELI™ QUICK MOUNTS

An alternative to panel frames, Peli™ Quick Mounts attach to the inside case wall using special adhesives. The interface panel can then be mounted on top of the Peli™ Quick Mounts and secured with screws (for Pelican™ Protector Case™ models only).



CUSTOM LOGO SERVICES

Personalize the outside of the case with your company logo or have your name engraved on the nameplate (Pelican™ Protector Case™). Logos can be applied in multiple colors as a Mylar® decal (250 piece minimum) or as a vibrant fade-resistant, scratch-resistant hot-stamped ink.

ELECTRONIC INSTALLATIONS

Many Pelican™ Protector Case™ and Pelican™ Storm Case™ models allow customization for electronics. Injection molding provides a reliable, durable, ready-to-ship enclosure with consistent dimensions. The copolymer material can be machined, drilled and sanded smooth.

These properties make the Pelican™ Protector Case™ and Pelican™ Storm Case™ suitable

for use with bulkhead connectors. Attaching equipment to the interior is equally simple using common hardware such as bolts and rivets. The hardware can be made watertight by use of o-rings, rubber gaskets or silicone.

Mounting the entire case to a wall or post is a simple way to create a waterproof control box for field use.

For prices and further information, please call Pelican Customer Service at 310.326.4700 or toll free at 800.473.5422.

CUSTOM CASE SOLUTIONS

While every Pelican™ case is built tough on the outside, we provide custom services to protect delicate items on the inside. Custom foam and extreme solutions such as deck mount suspension systems and

certified laboratory testing will keep your equipment organized, intact and protected through the most volatile conditions.

LOW COMPLEXITY Custom Foam Solutions



MEDIUM COMPLEXITY Interior/Exterior Solutions



EXTREME COMPLEXITY Interior/Exterior Solutions with Testing Requirements

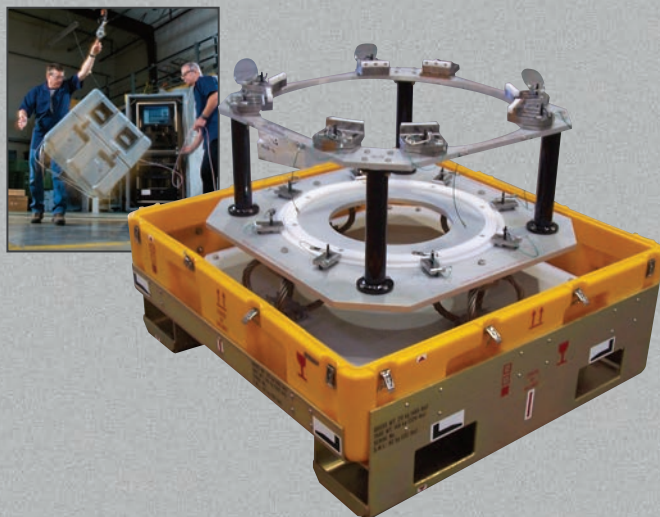

EXAMPLES

- Custom Labels
- Humidity Indicators
- Customizable cushions, such as Polyethylene and Polyurethane, in multiple densities, as well as other specialty foams

EXAMPLES

- Shock Mount Metal Decks
- Custom Metal Work
- Cut and Weld
- Custom Bezel Solutions
- Forklift Risers

EXAMPLES

- Shock Testing
- Vibration Testing
- Drop Testing
- Salt/Fog Testing
- Pressure Testing

CUSTOM FOAM MADE SPECIFICALLY FOR YOUR EQUIPMENT

Pelican Products provides expert packaging solutions for both of our case lines, and we work with partners who have been in the packaging industry for over 50 years. Save time and cost by purchasing a fast and complete turnkey solution from Pelican.

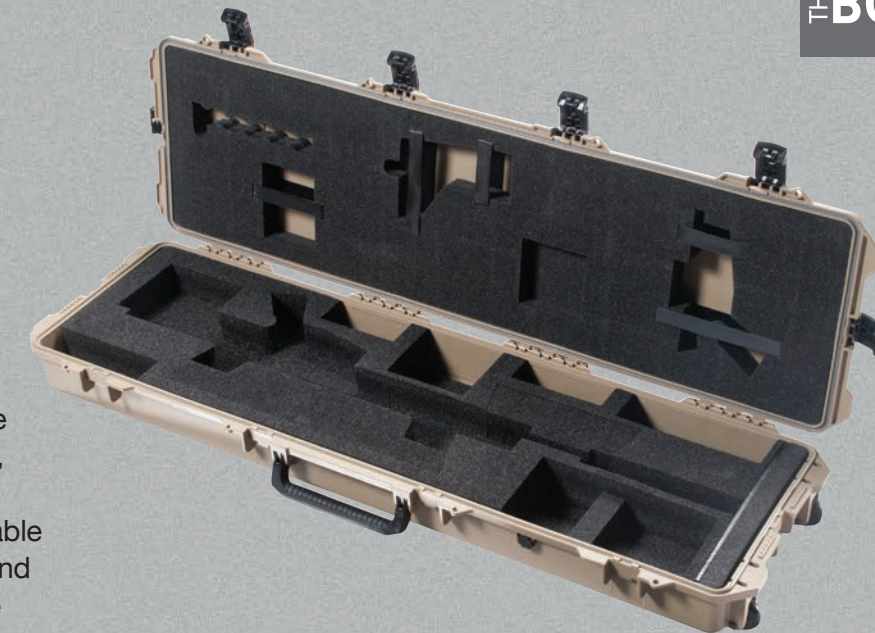

Our Pelican Case Centers have the most advanced foam cutting tools, and our engineers have the latest software applications so they are able to create a design that is precise and determines the most cost effective method of manufacture.



Water Jet Technology



Die Cut Technology



CNC Router Technology

PELICAN ENGINEERS TAKE EVERYTHING INTO CONSIDERATION WHEN DESIGNING YOUR CUSTOM CUSHION:

- Unit Dimensions
- Accessories and Other Items
- Fragility
- Military Specifications
- UV Resistance
- Commercial Spec
- Anti Static Grounding
- Weight and Weight Distribution
- Size Restrictions
- Shipping Method and Frequency (ground, air or "around the town")
- Option Requirements
- ...and more

All of this information allows us to choose the right Pelican™ case and foam type for your application.

NOT ALL FOAM IS EQUAL

With over 50 years of professional packaging experience, Pelican engineers utilize sophisticated engineering technology to provide a foam solution that not only serves to protect, but also creates a professional presentation that you will be proud to display.

From simple to very complex cushion designs, we know how to provide protection that will get your gear or mission critical items safely to their destination.



CUSHIONING MATERIAL

POLYURETHANE:

Commonly used, polyurethane is a softer, open cell foam. Best for lighter weight sensitive equipment such as cameras, smartphones and laptops. Available in a variety of densities.

ANTI-STATIC POLYURETHANE:

This special foam inhibits the build up of static electricity and helps dissipate any stray static charge. It is an open cell foam that is used for lightweight items such as sensitive electronic equipment, e.g. circuit boards, computer chips, etc.

POLYETHYLENE:

Polyethylene foam is a strong, non-abrasive, water-resistant and resilient closed cell foam. Due to its excellent vibration dampening and insulation properties, it is often used for packaging fragile goods such as communications equipment, power supplies, etc. Available in a variety of densities.

ANTI-STATIC POLYETHYLENE:

Commonly used for shipping electronic parts, circuit boards and computer chips, anti-static polyethylene foam is a strong, non-abrasive, water-resistant and resilient closed cell foam. The properties of the foam slowly dissipate electrostatic charges given off by other components. Used for shock absorption, it is often used for packaging fragile goods due to its excellent vibration dampening and insulation properties.

CROSS-LINK:

Is a non-porous, non-particulate closed cell foam that is often used in a clean room environment (reduces foreign object debris – FOD). It is aesthetically pleasing and resistant to grease, dirt and water. Available in a variety of densities.

ADDITIONAL FOAM TYPES ARE AVAILABLE: FLAME-RETARDANT, CONDUCTIVE, EXPANDED FOAMS...



CUSTOM FOAM APPLICATION EXAMPLES:

- Consumer Products
- Firearms
- Computers
- Calibrated Optics
- Tools
- Video Equipment
- Bottles
- Paintings
- Musical Instruments
- Collectibles
- Any Item That You Value and Need To Protect

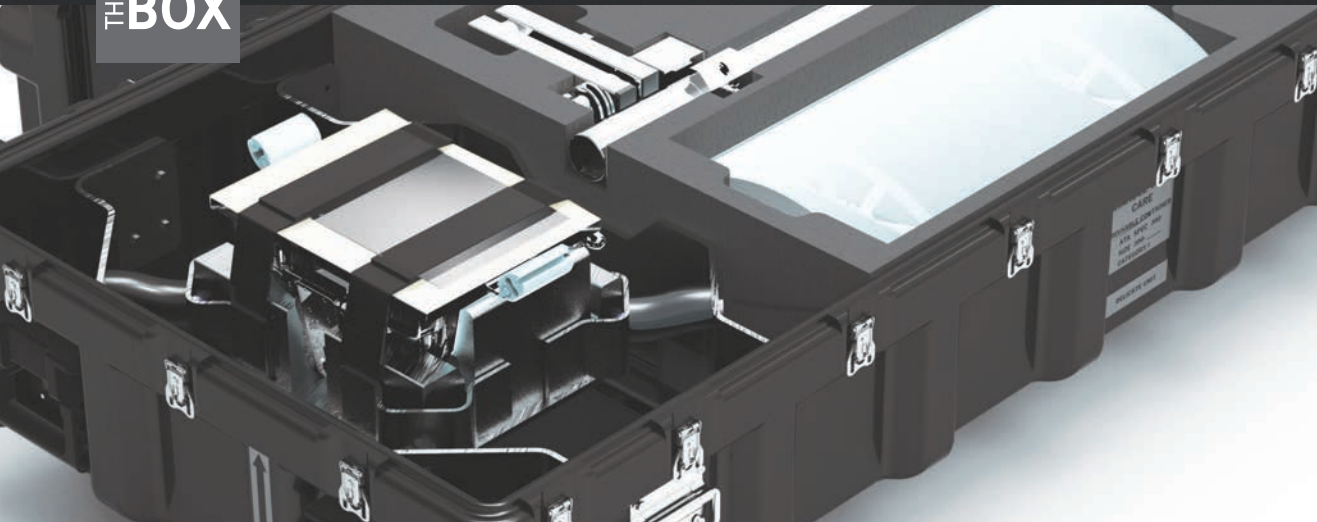

BEYOND FOAM

When foam is not appropriate, Pelican specializes in custom metal work to help keep your equipment secure and stable, to arrive without a scratch.

LAB TESTING

Military and OEM customers may need to certify the case will perform to specific requirements. Under precise control conditions we subject our cases to a battery of rigorous lab tests including drop, vibration, leak, heat and dust tests.

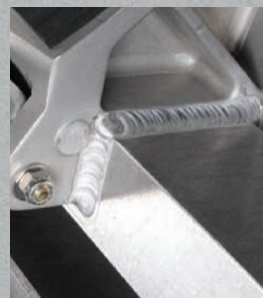

DECK MOUNT SUSPENSION SYSTEM

While foam is generally the first choice for protection, heavy or extremely fragile equipment sometimes requires fabrication of custom deck mount suspension systems to secure equipment. Cradle mounts are also the choice when the equipment can only be supported in precise locations. Pelican's machine shop is world-class, with plasma cutters, certified welders and finishing services demanded by the aerospace, defense and medical industries.

VIBRATION CONTROL

Small but constant vibration during transport is very destructive to the equipment inside a case. Pelican uses elastomer shock mounts, cable shock isolators, hard mounts, and foam that isolate the payload from case walls. Specialized foams can also mitigate vibration; our engineers understand the properties of foam to specify the type that is right for your requirements.



VIBRATION TEST

- L.A.B. servo hydraulic vibration system; 0 – 300 Hz.
- Sinusoidal with pre-programmed profiles for:
 - ISTA Integrity test procedures 11800, 14200, 1A, 1B, 1E, 1C, 1D, 2A AND 2B.
 - FED-STD-101C; 5019-1
 - 3 – 50 Hz sweep with 1G constant input
 - 1 inch dwell for loose cargo bounce
 - Mil-Std-648C; 5.3.2

- Random Vibration with pre-programmed profiles for:

- ASTM D 4169 Air levels 1, 2, and 3
- ASTM D 4169 Truck levels 1, 2, and 3
- ASTM D 4169 Rail levels 1, 2, and 3
- ISTA Integrity Test Procedures 1E, 1H, 1C, 1D, 1F, 3C, 3D, and 3E.

DROP TESTING

- Six foot cube reaction mass of reinforced concrete. A hoist capable of lifting 1 ton, and a quick release mechanism with a load capacity of ½ ton.

IMPACT TEST

- Falling dart – 84 inch drop height with darts weighing between 5 and 15 lbs.
- Penetration test for category 1 containers - ATA 300 paragraph B-2-5

THERMAL TEST

- Walk in environmental chamber 6-foot wide by 8 foot high and 8 feet deep with a thermal range of -100°F to 200°F.

IMMERSION TEST

- Internal dimension of the chamber is 54" x 30" x 36"H. Able to simulate immersions up to 2 meters.
- Small immersion tank capable of immersions up to 1 meter on small IM cases.
- 80 inch deep large immersion tank

RAIN TEST

- Small rain chamber capable of up to 4 inches per hour.

PNEUMATIC PRESSURE TESTING

- 100" and 80" water manometers
- 100" mercury manometer.
- Digital manometer – 10 psi max.

MITUTOYO™ HARDNESS TESTER

- Metal evaluation of product used in cases.

COMPRESSION AND TENSILE TESTING

- Instron compression tester, model 3367.
- Load range of 6600 lbs on small items.

LEAK TEST

- Immersion: 54" x 30" x 36" high chamber. Able to simulate immersions up to 2 meters.
- Rain: Small rain chamber capable of up to 4 in. per hour.
- Pneumatic Pressure: 100" and 80" water manometers. 100" mercury manometer.
- Digital manometer – 10 psi max.



GET 20% TOUGHER AND HUNDREDS OF ADDITIONAL SIZE OPTIONS: ROTATIONALLY MOLDED CASES

Our rotatorially molded cases begin as resin powder, measured and loaded into a mold attached to a biaxial arm. As the mold rotates and heats up, 20% more resin accumulates in the corners and edges where it is needed most. This ensures that your case holds up against extreme drops and impacts.

Each case is made in the USA and many are tested to Mil-Spec standards. With over 400 case sizes available, you get more options that have passed rigorous testing to ensure your equipment moves through punishing environments unrattled.

CHOICE

With hundreds of case sizes and options available, we have the widest range of standard configurations in the industry.



SINGLE LID CASES

Rugged protection with detachable lids for easy access.



RACK MOUNT CASES

Built-in shock absorbing frames protect electronic equipment.



ISP CASES (INTER-STACKING PATTERN)

Best protection for pallet shipments.

STANDARD ACCESSORIES

								
Casters	Edge Casters (standard on MAC with 5" Lid)	Caster Storage in Lid	Metal or Comfort Grip Handles	Extra Handles	Card Holders	ID Plates	Front Labels	Standard Labels
								
Custom Stenciling	Airtight/Watertight Valves	Coupling Catches	Humidity Indicators	Lid Hangers	Lid Storage Pouches	Lift Rings/Tie Down Rings	Leg Kit Chair or Tables	Lockable Cable Catches (1 set of 4 ea)

OPTIONAL COLORS FOR ALL SINGLE LID CASES

Gray – 133 Fed Std# 26270	Tan – 250 Fed Std# 20372	Blue – 135(lt) Pantone# 292U	White – 132 Fed Std# 27925	Yellow – 136 Pantone# 012U	Green – 138(forest) Fed Std# 24052	Orange – 134 Fed Std# 12197
Yellow – 131 Fed Std# 23538	Maroon – 197 Pantone# 202U	Blue – 101(dk) Fed Std# 25052	Black – 032 Fed Std# 27040	Red – 130 Fed Std# 21105	Olive Drab – 137 Fed Std# 34096	Purple – 129 Pantone# 245U

Note: Some options are not available on all case sizes and availability is subject to change at manufacturer's discretion. Case colors/options may differ slightly from printed versions.

FLASHLIGHTS - PELICAN LIMITED LIFETIME GUARANTEE OF EXCELLENCE

Pelican Products, Inc. guarantees its lights for a lifetime against breakage or defects in workmanship. This guarantee does not cover the lamp or batteries. All warranty claims of any nature are barred if the product has been altered, damaged or in any way physically changed, or subjected to abuse, misuse, negligence or accident.

REMOTE AREA LIGHTING SYSTEMS - PELICAN

1 YEAR LIMITED WARRANTY FOR RALS PRODUCTS

Pelican Products, Inc. guarantees to the original purchaser of its RALS products that its products will be free of defects in materials and workmanship for one year from the date of purchase. All warranty claims of any nature are barred if the product has been altered, damaged or in any way physically changed, or subjected to abuse, misuse, negligence or accident.



PELICAN

LIGHTS CATALOG

TOUGH LIGHTING TOOLS

FEBRUARY 2019



SINCE 1976

FEBRUARY 2019



MARKETS SERVED //

**FIRE
MILITARY
INDUSTRIAL
LAW ENFORCEMENT
OUTDOOR
CONSUMER
DIVE**

DEAR CUSTOMER,

Lighting tools – they're a core element of every toolbox. They have a straightforward and simple purpose. Yet, when you're in a situation that requires a lighting tool, you want to make sure you have the right one. Pelican understands the critical importance of this tool. We provide a wide range of advanced lighting systems to support professionals, outdoor enthusiasts and everyday do-it-yourself hobbyists. Regardless of the purpose, our lighting tools and remote area lighting systems enable you to accomplish your tasks in a safer and more efficient manner.

With this perspective, Pelican relentlessly pursues innovation for new lighting tool products and manufacturing processes. We have adopted the ANSI FL-1 flashlight standards (see page 1) and continue to increase the number of industry leading safety certificates for specific models.



Our new lighting catalog features multiple technology advances. These include state of the art LED performance upgrades, new electronic features, upgraded safety certificates and enhanced packaging. We are committed to environmentally responsible manufacturing, in fact most of our lights use LED bulbs that help protect our planet. LEDs are long lasting, promote extended battery life and allow for the latest technological advancements.

From basic models to the high-performance 9410L LED Lantern (our brightest handheld flashlight to date) and the 9470 Remote Area Lighting System (which delivers 12,000 lumens), we are ready to provide world-class support for our dealers and end users across the globe. And, all of this comes with Pelican's industry-leading guarantee of excellence.

We invite you to look through our new catalog and discover the ideal lighting tools for your specific needs.

CEO and President
Lyndon Faulkner

©2019 Pelican Products, Inc. All trademarks are registered and/or unregistered trademarks of Pelican Products, Inc., its subsidiaries and/or affiliates. Lexan® is a registered trademark of SABIC. iOS is a registered trademark of Apple, Inc. BLUETOOTH is a registered trademark of Bluetooth Sig, Inc. Android is a trademark of Google Inc. BLACK JACK™ is a trademark of 1445 Designs Corporation. 3M is a trademark of 3M Company

Part No. 0030-000-200 FE/19

PELICAN LIGHTS

PRODUCT LINE OVERVIEW

5 SERIES LIGHTS PGS 3 - 4				CORRECT COLOR LIGHTS PGS 5 - 6						REMOTE AREA LIGHTING SYSTEMS PGS 7 - 10													
5000 NEW	5010 NEW	5020 NEW	5050R NEW	2750CC NEW	2755CC NEW	3310CC NEW	3315CC NEW	3410CC NEW	3415CC NEW	9430	9430SL	9440	9455	9460	9460M	9470	9470M	9480	9490	9500	9600 NEW		
SMALL LIGHTS PGS 11 - 12										MEDIUM LIGHTS PGS 13 - 16													
1810	1830	1910	1920	1930	1965	1970 NEW	1975 NEW	2220		2010	2010PL	2410	2410PL	2460	3310PL	3310ELS	3310R	3315	3315PL	3315R	3325	3345 NEW	
LARGE LIGHTS PGS 17 - 18					TACTICAL LIGHTS PGS 19 - 20																		
9410L	9415		2350	2360	2370	PM6 3330	7000	7060	7070R NEW	7100	7110 NEW	7600	7610 NEW	7620 NEW	8060								
HEADLAMPS PGS 21 - 24																							
2610	2690	2720	2740	2745	2750	2755	2760	2765	2780	2780R	2785												
RIGHT ANGLE LIGHTS PGS 25 - 28												DIVE LIGHTS PGS 29 - 30				SPECIALTY LIGHTS PGS 31 - 32							
3310R-RA	3315R-RA	3410	3410M	3415	3415M	3610	3610PL	3660	3715	3715PL	3765	3765PL	1960N	2010N	2410N	2130	2130IR	2365	2490				



PELICAN LIGHTING TOOLS: MORE THAN JUST FLASHLIGHTS.

Here are just a few features that make our lighting tools shine:



WIRELESS BLUETOOTH™ CONTROL
(on select models only)



SELF PROGRAMMABLE
(on select models only)



GESTURE ACTIVATION
(on select models only)



PHOTOLUMINESCENT DESIGNS
(on select models only)



BATTERY LEVEL INDICATION
(on select models only)

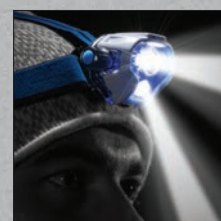

DOWNCAST LIGHTING FEATURES
(on select models only)



SUBMERSIBLE APPLICATIONS
(on select models only)



LEGENDARY LIFETIME GUARANTEE



INTELLIGENT CONTROL
(on select models only)



TABLE OF CONTENTS

PERFORMANCE & SAFETY	1-2
5 SERIES LIGHTS	3-4
CORRECT COLOR LIGHTS	5-6
REMOTE AREA LIGHTING SYSTEMS	7-10
SMALL LIGHTS	11-12
MEDIUM LIGHTS	13-16
LARGE LIGHTS	17-18
TACTICAL LIGHTS	19-20
HEADLAMPS	21-24
RIGHT ANGLE LIGHTS	25-28
DIVE LIGHTS	29-30
SPECIALTY LIGHTS	31-32
LIGHT MOUNTING SYSTEMS	
HOLSTERS AND HELMET HOLDERS	33-34
SPECIFICATIONS	35-38
CUSTOM LABELS LIGHTING FEATURES	39-40

PERFORMANCE

ANSI STANDARDS (AMERICAN NATIONAL STANDARDS INSTITUTE)

Why create standards? While Pelican was one of the first manufacturers to use quantifiable test procedures, the need was recognized to develop a common language that customers could use to select the right flashlight for their specific needs. As a result, the American National Standards Institute (ANSI), with input from the

flashlight industry, developed performance standards and symbols to effectively communicate a flashlight's features and benefits.

The resulting ANSI/NEMA FL 1 Standards include the following six criteria:

STANDARDS AND RATINGS (APPLICABLE TO FLASHLIGHTS ONLY)

LIGHT OUTPUT

Light Output is the total luminous flux. It is the total quantity of emitted overall light energy as measured by integrating the entire angular output of the portable light source. Light output in this standard is expressed in units of lumens.

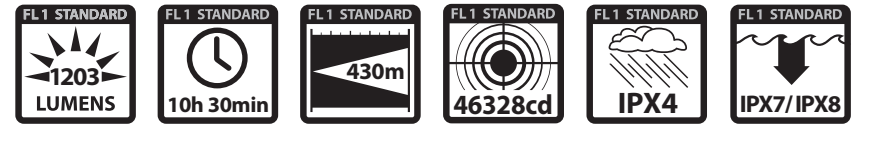

RUN TIME

Run Time is defined as the duration of time from the initial light output value – defined as 30 seconds after the point the device is first turned on – using fresh batteries, until the light output reaches 10% of the initial value.

BEAM DISTANCE

Beam Distance is defined as the distance from the device at which the light beam is 0.25 lux (0.25 lux is approximately the equivalent of the light emitted from the full moon "on a clear night in an open field").

WATER RESISTANT

Water Resistant – IPX4 Water splashed against the device from any direction shall have no harmful effects.

WATERPROOF/SUBMERSIBLE

Water Proof // IPX7 – Ingress of water in quantities causing harmful effects shall not be possible when the enclosure is temporarily immersed in water under standardized conditions of pressure and time. Submersible // IPX8 – Ingress of water in quantities causing harmful effects shall not be possible when the enclosure is continuously immersed in water under conditions which shall be stated by manufacturer, but which are more severe than for IPX7.

PEAK BEAM INTENSITY

Peak Beam Intensity is the maximum luminous intensity typically along the central axis of a cone of light. The value is reported in candela and does not change with distance.

GLOSSARY OF TERMS

Candela A unit of measurement of the intensity of light that is emitted by a light source in a particular direction.

Lux The unit of luminous flux in the International System, equal to the amount of light given out through a solid angle by a source of one candela intensity radiating equally in all directions.

Lumen A unit of measurement of the amount of brightness that comes from a light source. Lumens define "luminous flux," which is energy within the range of frequencies we perceive as light.

Integrating Sphere An integrating sphere is a measurement device with an entrance port that can accept all the directional light output of the device under test, or can totally enclose the device itself. The walls of the sphere should be highly diffused with high reflectivity (>80%) and the spectroradiometer should be shielded from direct view of the device under test by a baffle system.

Rechargeable Denotes a flashlight which contains rechargeable batteries and charging station. These models are shown with the rechargeable icon.



IP (Ingress Protection) – These ratings specify the environmental protection the enclosure provides. The IP rating normally has two numbers (IPXX). The first number represents protection from solid objects or materials (dust) whereas the second number represents protection from liquids (water). With the IP rating IP 54, 5 describes the level of protection from solid objects and 4 describes the level of protection from liquids as described by the IP Rating System (Solids vary from 0-6 IP rating, Liquids vary from 0-8 IP rating).



INTRINSICALLY SAFE. YOUR PASSPORT THROUGH HAZARDOUS LOCATIONS

Whether working in a Class I Oil Refinery or in the silo of a Class III Textile Mill, safety is always a concern and your lighting tool shouldn't add to your worries. Pelican builds lighting tools certified for hazardous work environments. In fact we make more safety approved lights certified for **Class I II III Div. 1** and groups **ABCDEFG** than anyone else.

HAZARDOUS AREA ELECTRICAL GUIDELINES

	CLASSIFICATIONS	SUBSTANCE	TYPICAL ENVIRONMENTS
CLASS I	DIVISION 1	Flammable Gases, Vapors, or Liquids	Oil Refinery, Paint Warehouse Spray Booth, Offshore Oil Rig
	DIVISION 2		
CLASS II	DIVISION 1	Combustible Dusts	Coal Mine, Munitions Factory, Grain Silo, Hay Storage Facility
	DIVISION 2		
CLASS III	DIVISION 1	Ignitable Fibers & Flyings	Paper Mill, Woodworking Facility, Textile Mill, Cotton Gin
	DIVISION 2		

Division 1 (hazard likely): Where volatile substances can exist all of the time or some of the time under normal operating conditions.
Division 2 (hazard not likely): Where volatile substances are not likely to exist under normal operating conditions.

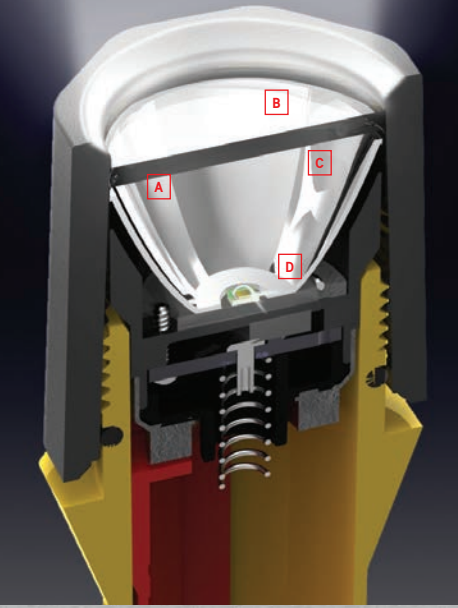

NEW DEEP MOUNT LED TECHNOLOGY

Our engineering team has designed a new high performance LED lamp module (Deep Mount LED Module). These lights are now brighter, with close to 100% increase in lumens and a 2.5 times increase in lux value over previous versions (as well as offering a more robust design).

- A** New deep dish reflector provides up to 2.5 times lux increase, and 100% lumen increase
- B** Robust, over-molded polycarbonate lens won't yellow
- C** Opti-mechanical design gathers and focuses 100% of the light
- D** LED is mounted directly to the PCB board, creating a strong and efficient design solution

5 SERIES FLASHLIGHTS

Our new 5 Series flashlights feature slide beam technology. The flood position projects a wide beam to illuminate your work area or use the spot beam for a long distance focused beam.

← FLOOD BEAM

UP TO 78° BEAM SPREAD

UP TO 250 YARDS OF LONG
DISTANCE VISIBILITY

SPOT BEAM →

SLIDE BEAM TECHNOLOGY

5000

LIGHT SOURCE //
LED
BATTERIES //
2 AAA Alkaline (included)
LENGTH //
5.59" (14.2 cm)
MODES //
High / Low / Flashing



NEW

LUMENS
202
RUN TIME
7h
UP TO

5010

LIGHT SOURCE //
LED
BATTERIES //
2 AA Alkaline (included)
LENGTH //
6.26" (15.9 cm)
MODES //
High / Low / Flashing



NEW

LUMENS
392
RUN TIME
26h
UP TO

5020

LIGHT SOURCE //
LED
BATTERIES //
4 AAA Alkaline (included)
LENGTH //
5.87" (14.9 cm)
MODES //
High / Medium / Low / Flashing



NEW

LUMENS
586
RUN TIME
27h
UP TO

5050R

LIGHT SOURCE //
LED
BATTERIES //
Lithium-Ion (included)
LENGTH //
6.16" (15.6 cm)
MODES //
Boost / High / Low / Flashing



NEW

LUMENS
883
RUN TIME
40h
UP TO



USB

CORRECT COLOR FLASHLIGHTS

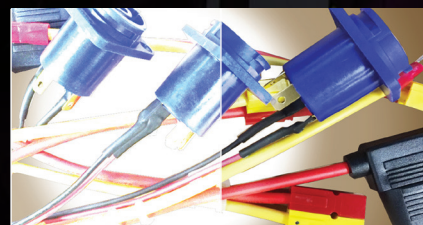

70 CRI
CONVENTIONAL
FLASHLIGHTS

90+ CRI
CORRECT
COLOR TECHNOLOGY

When you can't see the difference between one color cable and another, the job may be compromised. Now you can trust our select flashlights with new Correct Color technology to end the guess work.

2750CC HEADLAMP

LIGHT SOURCE //
LED
BATTERIES //
3 AAA Alkaline (included)
LENGTH //
2.25" (5.7cm)
MODES //
High / Low / Flashing
■ (Photoluminescent)



NEW

LUMENS
183
RUN TIME
11h
UP TO

2755CC HEADLAMP

LIGHT SOURCE //
LED
BATTERIES //
3 AAA Alkaline (included)
LENGTH //
2.25" (5.7 cm)
MODES //
High / Low / Flashing
CERTIFICATIONS //
CI, D1, IECEx ia
■



NEW

LUMENS
72
RUN TIME
15h
UP TO
SAFETY
CERTIFIED

3310CC

LIGHT SOURCE //
LED
BATTERIES //
3 AA Alkaline (included)
LENGTH //
6.14" (15.6 cm)
MODES //
High / Low / Flashing
■ (Photoluminescent)



NEW

LUMENS
238
RUN TIME
175h
UP TO

3315CC

LIGHT SOURCE //
LED
BATTERIES //
3 AA Alkaline (included)
LENGTH //
6.14" (15.6 cm)
MODES //
On / Off
CERTIFICATIONS //
CI II II, D1, IECEx ia
■



NEW

LUMENS
130
RUN TIME
16h 30m
UP TO
SAFETY
CERTIFIED

3410MCC

LIGHT SOURCE //
LED
BATTERIES //
3 AA Alkaline (not included)
LENGTH //
7.44" (18.9 cm)
MODES //
High / Medium / Low / Flashing
Spot / Flood / Both
■ (Photoluminescent)



NEW

3410MCC Includes
Magnetic Clip



3415MCC

LIGHT SOURCE //
LED
BATTERIES //
3 AA Alkaline (not included)
LENGTH //
7.44" (18.9 cm)
MODES //
High / Flashing
Spot / Flood / Both
CERTIFICATIONS //
CI II II, D1, IECEx ia
■



NEW

3415MCC Includes
Magnetic Clip





RAALS

REMOTE AREA LIGHTING SYSTEMS

Providing increased performance, safer working conditions, emergency preparedness and greater flexibility, Pelican's RALS line is the modern alternative to generator based lighting:

- Silent performance
- No exhaust fumes
- No flammable fuel
- Remote activation
- Eliminated trip hazards
- Little to no heat

9430 RALS

LIGHT SOURCE // LED
 BATTERIES // Sealed Lead Acid
 DIMENSIONS // 15.75" (40 cm) Closed, 32.28" (82 cm) Extended
 MODES // High / Low
 BEAM SPREAD // 125°, 6 LEDs

LUMENS
 3000
 RUN TIME
 15h
 UP TO



9430SL SPOT LIGHT RALS

LIGHT SOURCE // LED
 BATTERIES // Sealed Lead Acid
 DIMENSIONS // 15.75" (40 cm) Closed, 32.28" (82 cm) Extended
 MODES // High / Low
 BEAM SPREAD // 10°, 24 LEDs

LUMENS
 2000
 RUN TIME
 15h
 UP TO



9600 RALS

LIGHT SOURCE // LED
 INPUT VOLTAGE // 110v - 240v
 DIMENSIONS // Light Head - 18.31" x 8.27" x 4.72" (46.5 x 21 x 12 cm) Extended - 120" (304.8 cm) [with base & pole]
 BEAM SPREAD // 125°, 14 LEDs

LUMENS
 3000
 RUN TIME
 UP TO

*Shown with base & pole accessories

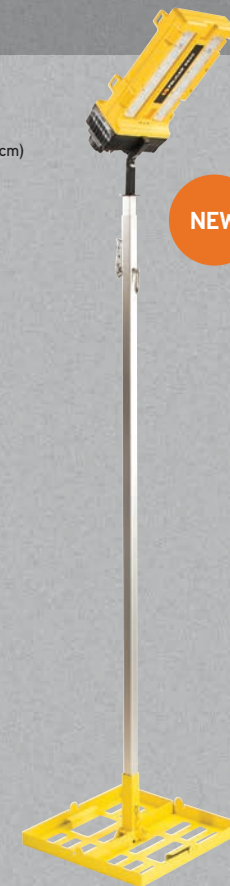

NEW

9440 RALS

LIGHT SOURCE // LED
 BATTERIES // Lithium-Ion
 DIMENSIONS // 37.4" (95 cm) Closed, 85" (215.8 cm) Extended
 MODES // High / Medium / Low
 BEAM SPREAD // 120°, 10 LEDs

LUMENS
 5300
 RUN TIME
 8h
 UP TO



Bluetooth

9455 SAFETY LIGHT RALS

LIGHT SOURCE // LED
 BATTERIES // NiMH
 DIMENSIONS // 15.35" (39 cm) Closed, 31.50" (80 cm) Extended
 MODES // High / Low / Flashing
 BEAM SPREAD // 125°, 10 LEDs
 CERTIFICATIONS // CI, D1, IECEx ia, ATEX Zone 0

LUMENS
 1600
 RUN TIME
 10h
 UP TO



9500 SHELTER LIGHTING SYSTEM

LIGHT SOURCE // LED
 INPUT VOLTAGE // 110-240vac
 DIMENSIONS // 20.62" (52.4 cm) Closed, 157.5" (399.9 cm) Extended
 LIGHT OUTPUT // 6000 (White LED) Per Head, 1200 (Red LED) Per Head
 BEAM SPREAD // 210° Diffused, 36 LEDs per head (24 White/12 Red), 3 lamp heads
 PELICAN CASE // Included

LUMENS
 6000
 RUN TIME
 UP TO

Select between white light or red night vision mode

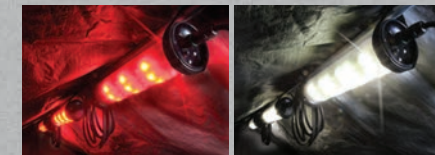

9460/9460M RALS

LIGHT SOURCE // LED
BATTERIES // Sealed Lead Acid
DIMENSIONS // 23.25" (59.1 cm) Closed, 79.50" (201.9 cm) Deployed
MODES // Variable Light Output / Flashing / 3 Preset Levels
BEAM SPREAD // 120°, 10 LEDs per head, 2 lamp heads



INTELLIGENT CONTROL SYSTEM
 calculates and displays current battery life, allowing the user to regulate the intensity of the light and choose the desired run time.



9460



9460M



9460, 9460M, 9470, 9470M FEATURES



12V POWER SUPPLY WITH DUAL USB ADAPTER
 12 volt power supply port can be used to power any electrical product that utilizes a standard 12v vehicle style connector (up to 4 amps) or a variety of USB connections.



BLUETOOTH™ CONTROL
 Bluetooth app controls multiple units and variable light from 0-100% output. Free App for iOS™ and Android™.

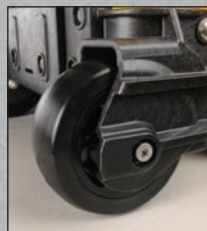

MULTI-TERRAIN TROLLEY (ONLY ON 9460M, 9470M)
 Large 1.5 inch polyurethane wheels allow for easier transport across rough surfaces. Molded feet level and stabilize case.

9470/9470M RALS

LIGHT SOURCE // LED
BATTERIES // Sealed Lead Acid
DIMENSIONS // 24.75" (62.9 cm) Closed, 80.00" (208.3 cm) Deployed
MODES // Variable Light Output / Flashing / 3 Preset Levels
BEAM SPREAD // 120°, 10 LEDs per head, 4 lamp heads



INTELLIGENT CONTROL SYSTEM
 calculates and displays current battery life, allowing the user to regulate the intensity of the light and choose the desired run time.



9470



9470M



9480 RALS

LIGHT SOURCE // LED
BATTERIES // Sealed Lead Acid
DIMENSIONS // 15.50" (39.4 cm) Closed, 23.75" (60.3 cm) Deployed
MODES // High / Medium / Low / Flashing
BEAM SPREAD // 125°, 8 LEDs

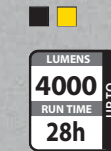

INTELLIGENT CONTROL SYSTEM
 calculates and displays current battery life, allowing the user to regulate the intensity of the light and choose the desired run time.



SWAPPABLE POWER PACK
 Swappable power pack w/12v aux. port adapter powers smartphones, laptops, etc.



BATTERY LEVEL INDICATOR
 Full time battery level indication.

9490 RALS

LIGHT SOURCE // LED
BATTERIES // Sealed Lead Acid
DIMENSIONS // 20" (50.8 cm) Closed, 72" (182.9 cm) Deployed
MODES // High / Medium / Low / Flashing / (6000-Variable)
BEAM SPREAD // 125°, 10 LEDs



INTELLIGENT CONTROL SYSTEM
 calculates and displays current battery life, allowing the user to regulate the intensity of the light and choose the desired run time.



BLUETOOTH™ CONTROL
 Bluetooth app controls multiple units and variable light from 0-100% output Free App for iOS™ and Android™.





SMALL LIGHTS

When compact size is a must or just a convenience, choose from Pelican's range of powerful lights. Whether composite or alloy, certified or colored, you'll find the perfect model for your next job.

1810

LIGHT SOURCE // LED
 BATTERIES // 4 LR 41 Alkaline (included)
 LENGTH // 1.50" (3.8 cm)



LUMENS
16
RUN TIME
8h 30m

L4™ 1830

LIGHT SOURCE // LED
 BATTERIES // 3 AAAA Alkaline (included)
 LENGTH // 6.2" (15.7cm)
 CERTIFICATIONS // CI, D1



LUMENS
5
RUN TIME
32h
SAFETY CERTIFIED

1910

LIGHT SOURCE // LED
 BATTERIES // 1 AAA Alkaline (included)
 LENGTH // 3.8" (9.7cm)
 MODES // High / Low



LUMENS
106
RUN TIME
4h
UP TO

1920

LIGHT SOURCE // LED
 BATTERIES // 2 AAA Alkaline (included)
 LENGTH // 5.5" (14.0cm)
 MODES // High / Low



LUMENS
224
RUN TIME
8h 45m
UP TO

L1™ 1930

LIGHT SOURCE // LED
 BATTERIES // 4 LR 44 Alkaline (included)
 LENGTH // 2.64" (6.7cm)
 CERTIFICATIONS // CI, D1/CII, D2



LUMENS
12
RUN TIME
4h 15m
SAFETY CERTIFIED

MITYLITE™ 1965

LIGHT SOURCE // LED
 BATTERIES // 2 AAA Alkaline (included)
 LENGTH // 5.48" (13.9cm)
 CERTIFICATIONS // CI II III, D1



LUMENS
87
RUN TIME
2h 30m
SAFETY CERTIFIED

1970

LIGHT SOURCE // LED
 BATTERIES // 2 AAA Alkaline (included)
 LENGTH // 5.75" (14.6cm)
 MODES // High



NEW

LUMENS
139
RUN TIME
4h 15m

1975

LIGHT SOURCE // LED
 BATTERIES // 2 AAA Alkaline (included)
 LENGTH // 5.75" (14.6cm)
 CERTIFICATIONS // CI II III, D1



NEW

LUMENS
117
RUN TIME
2h 15m
SAFETY APPROVED

VB3™ 2220

LIGHT SOURCE // LED
 BATTERIES // 2 CR2032 Lithium (included)
 LENGTH // 3.5" (8.9cm)
 CERTIFICATIONS // CI, D1



LUMENS
9
RUN TIME
34h
SAFETY CERTIFIED

MEDIUM LIGHTS

Nothing beats the versatility of a hand-held light. Easy to carry, stash in a pocket, or clip to a helmet, these lights do just about everything. And when hazardous areas are present, you can count on Pelican's line of safety certified lighting tools. You'll even find photoluminescent models made with "glow-in-the-dark" material to help you find your flashlight in an emergency.



SABRELITE™ 2010

LIGHT SOURCE // LED
 BATTERIES // 3 C Alkaline (not included)
 LENGTH // 8.11" (20.6cm)
 CERTIFICATIONS // CI II III, D1



SABRELITE™ 2010PL PHOTOLUMINESCENT SHROUD

LIGHT SOURCE // LED
 BATTERIES // 3 C Alkaline (not included)
 LENGTH // 8.11" (20.6cm)
 CERTIFICATIONS // CI II III, D1



STEALTHLITE™ 2410 LED

LIGHT SOURCE // LED
 BATTERIES // 4 AA Alkaline (included)
 LENGTH // 7" (17.8cm)
 CERTIFICATIONS // CI II III, D1



STEALTHLITE™ 2410PL PHOTOLUMINESCENT SHROUD

LIGHT SOURCE // LED
 BATTERIES // 4 AA Alkaline (included)
 LENGTH // 7" (17.8cm)
 CERTIFICATIONS // CI, II, III D1



STEALTHLITE™ 2460

LIGHT SOURCE // LED
 BATTERIES // NiMH (included)
 LENGTH // 7" (17.8cm)
 CERTIFICATIONS // CI II, D2



3310PL PHOTOLUMINESCENT

LIGHT SOURCE // LED
 BATTERIES // 3 AA Alkaline (included)
 LENGTH // 6.14" (15.6cm)
 MODES // High / Low / Flashing
 (flashlight body glows in the dark)
 (Photoluminescent)

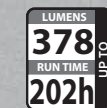

3310ELS (EMERGENCY LIGHTING SYSTEM)

LIGHT SOURCE // LED
 BATTERIES // 3 AA Alkaline (included)
 LENGTH // 6.14" (15.6cm)
 INCLUDES // 3310PL and Wall Mountable Case
 (flashlight body glows in the dark)
 (Photoluminescent)



3310R

LIGHT SOURCE // LED
 BATTERIES // Lithium-Ion (included)
 LENGTH // 6.11" (15.5cm)
 MODES // Boost / High / Low

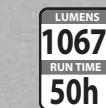

3315

LIGHT SOURCE // LED
 BATTERIES // 3 AA Alkaline (included)
 LENGTH // 6.14" (11.8cm)
 CERTIFICATIONS // CI II III, D1



SAFETY CERTIFIED

LUMENS
160
 RUN TIME
19h

3315PL PHOTOLUMINESCENT

LIGHT SOURCE // LED
 BATTERIES // 3 AA Alkaline (included)
 LENGTH // 6.14" (11.8cm)
 CERTIFICATIONS // CI II III, D1

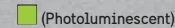

SAFETY CERTIFIED

LUMENS
160
 RUN TIME
19h

3315R



LIGHT SOURCE // LED
 BATTERIES // Lithium-Ion (included)
 LENGTH // 6.11" (15.5cm)
 CERTIFICATIONS // CI, D1



SAFETY CERTIFIED

LUMENS
132
 RUN TIME
34h

3325

LIGHT SOURCE // LED
 BATTERIES // 3 AA Alkaline (included)
 LENGTH // 6.06" (15.4cm)
 CERTIFICATIONS // CI, D1, IECEx ia



SAFETY CERTIFIED

LUMENS
162
 RUN TIME
16h

3345

LIGHT SOURCE // LED
 BATTERIES // 3 AA Alkaline (not included)
 LENGTH // 7.25" (18.4cm)
 CERTIFICATIONS // CI II III, D1, IECEx ia



SAFETY CERTIFIED

LUMENS
280
 RUN TIME
12h
 UP TO



LARGE LIGHTS

Colossal performance with lightweight designs. Features like full time battery level indication, articulating light head and multiple light modes keep you in control of the job. Pelican is also a leader of high performance lithium-ion technology in portable lighting.



9410L LED LANTERN



LIGHT SOURCE // LED
 BATTERIES // Lithium-Ion (included)
 LENGTH // 8.75" (22.2 cm)
 MODES // High / Low / Flashing
 Full Time Battery Indicator



9415 LED LANTERN



LIGHT SOURCE // LED
 BATTERIES // NiMH (included)
 LENGTH // 8.75" (22.2cm)
 MODES // High / Low / Flashing
 Full Time Battery Indicator
 CERTIFICATIONS // CI, D1



TACTICAL LIGHTS

Pelican's tactical lights are field ready, built to withstand the hard knocks that come with the job. Each intense, focused beam provides downrange visibility and peripheral lighting aids in situational awareness.

7110

LIGHT SOURCE // LED
 BATTERIES // 1 AA (included) or 1 CR123
 LENGTH // 4.63" (11.8cm)
 MODES // High / Strobe / Medium / Low
 PROGRAMMABLE // 5 Selectable Programs



NEW

LUMENS
 RUN TIME
 UP TO
445
13h

7600

LIGHT SOURCE // LED
 BATTERIES // Lithium-Ion (included)
 LENGTH // 6.19" (15.7cm)
 MODES // High / Strobe / Medium / Low
 LED COLORS // White / Red / Green
 PROGRAMMABLE // 5 Selectable Programs



USB
 LUMENS
 RUN TIME
 UP TO
944
29h

LIGHT SOURCE // LED
 BATTERIES // 1 AA (included) or 1 CR123
 LENGTH // 4.63" (11.8cm)
 MODES // High / Strobe / Medium / Low
 PROGRAMMABLE // 5 Selectable Programs

■

LIGHT SOURCE // LED
 BATTERIES // 2 CR123 Lithium-Ion
 LENGTH // 5.31" (13.5cm)
 MODES // High / Strobe / Medium / Low
 Self Programmable

■

2350

LIGHT SOURCE // LED
 BATTERIES // 1 AA Alkaline (included)
 LENGTH // 4.23" (10.7cm)
 MODES // High / Strobe / Low



LUMENS
 RUN TIME
 UP TO
178
21h

7000

LIGHT SOURCE // LED
 BATTERIES // 2 CR123 Lithium-Ion
 LENGTH // 5.31" (13.5cm)
 MODES // High / Strobe / Medium / Low
 Self Programmable



LUMENS
 RUN TIME
 UP TO
774
13h

2360 LED

LIGHT SOURCE // LED
 BATTERIES // 2 AA Alkaline (included)
 LENGTH // 6.2" (15.7cm)
 MODES // High / Strobe / Low



LUMENS
 RUN TIME
 UP TO
375
13h

7060

LIGHT SOURCE // LED
 BATTERIES // Lithium-Ion (included)
 LENGTH // 8.65" (22cm)
 MODES // High / Strobe / Medium / Low
 Self Programmable



LUMENS
 RUN TIME
 UP TO
402
57h

7610

LIGHT SOURCE // LED
 BATTERIES // 1 AA (included) or 2 CR123
 LENGTH // 5.44" (13.8cm)
 MODES // High / Strobe / Medium / Low
 PROGRAMMABLE // 5 Selectable Programs



LUMENS
 RUN TIME
 UP TO
1018
33h

■

LIGHT SOURCE // LED
 BATTERIES // 2 AA (included), 2 CR123 or 3 CR123
 LENGTH // 6.75" (17.15cm)
 MODES // High / Strobe / Medium / Low
 PROGRAMMABLE // 5 Selectable Programs

■

2370

LIGHT SOURCE // LED
 BATTERIES // 2 AA Alkaline (included)
 LENGTH // 6.43" (16.3cm)
 MODES // High / Low / Red / Blue
 LIGHT COLORS // White / Red / Blue



LUMENS
 RUN TIME
 UP TO
358
11h

7070R

LIGHT SOURCE // LED
 BATTERIES // Lithium-Ion (included)
 LENGTH // 6.88" (17.5cm)
 MODES // High / Strobe / Medium / Low
 PROGRAMMABLE // 5 Preset Selectable Programs / Customizable Programs (via Bluetooth™)



NEW

Bluetooth
 WIRELESS CHARGING

LUMENS
 RUN TIME
 UP TO
1219
32h

7620

LIGHT SOURCE // LED
 BATTERIES // 2 AA (included), 2 CR123 or 3 CR123
 LENGTH // 6.75" (17.15cm)
 MODES // High / Strobe / Medium / Low
 PROGRAMMABLE // 5 Selectable Programs



NEW

LUMENS
 RUN TIME
 UP TO
1124
37h

■

PM6 3330

LIGHT SOURCE // LED
 BATTERIES // 2 CR123 Lithium-Ion (included)
 LENGTH // 5.27" (13.4cm)



LUMENS
 RUN TIME
 UP TO
90
4h 45m

7100

LIGHT SOURCE // LED
 BATTERIES // Lithium-Ion (included)
 LENGTH // 5.12" (13cm)
 MODES // High / Strobe / Medium / Low
 PROGRAMMABLE // 5 Selectable Programs



USB
 LUMENS
 RUN TIME
 UP TO
695
9h 15m

8060

LIGHT SOURCE // LED
 BATTERIES // NiMH (included)
 LENGTH // 12.67" (32.2cm)
 MODES // High / Strobe / Medium / Low
 Flashing / Self Programmable



LUMENS
 RUN TIME
 UP TO
803
69h

■

HEADLAMPS

With up to 500 lumens, revolutionary downcast lighting, USB charging and battery level indication, these headlamps are packed with features. Other options, including night vision friendly red illumination, interchangeable body colors and multiple settings, make these headlamps your best partner for the dark.

HEADSUP LITE™ 2610

LIGHT SOURCE // LED
 BATTERIES // 3 AAA Alkaline (included)
 LENGTH // 1.49" (3.8cm)
 MODES // High / Low
 CERTIFICATIONS // CI, D1



HEADSUP LITE™ 2690

LIGHT SOURCE // LED
 BATTERIES // 3 AAA Alkaline (included)
 LENGTH // 2.81" (7.1 cm)
 CERTIFICATIONS // CI II III, D1



2720 HEADLAMP

LIGHT SOURCE // LED
 BATTERIES // 3 AAA Alkaline (included)
 LENGTH // 2.48" (6.3 cm)
 MODES // Variable Light Output / Spot to Flood / Red Night Vision Friendly LEDs



GESTURE
ACTIVATION
CONTROL

2740 HEADLAMP

LIGHT SOURCE // LED
 BATTERIES // 3 AAA Alkaline (included)
 LENGTH // 2.25" (5.7 cm)
 MODES // High / Low / Flashing / Red LED

■ ■ (Translucent Blue)



2745 HEADLAMP

LIGHT SOURCE // LED
 BATTERIES // 3 AAA Alkaline (included)
 LENGTH // 2.25" (5.7 cm)
 MODES // High / Low / Flashing
 CERTIFICATIONS // CI, D1

■ ■



2750 HEADLAMP

LIGHT SOURCE // LED
 BATTERIES // 3 AAA Alkaline (included)
 LENGTH // 2.25" (5.7 cm)
 MODES // High / Low / Flashing / Red LED / Low Battery Warning

■ ■ (Photoluminescent)

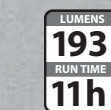

2755 HEADLAMP

LIGHT SOURCE //
LED
BATTERIES //
3 AAA Alkaline (included)
LENGTH //
2.25" (5.7 cm)
MODES //
High / Low / Flashing /
Low Battery Warning
CERTIFICATIONS //
CI, D1



2760 HEADLAMP

LIGHT SOURCE //
LED
BATTERIES //
3 AAA Alkaline (included)
LENGTH //
2.25" (5.7 cm)
MODES //
High / Medium / Low /
Downcast / Flashing/
Red LED / Full-time Battery
Level Indicator

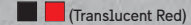

2765 HEADLAMP

LIGHT SOURCE //
LED
BATTERIES //
3 AAA Alkaline (included)
LENGTH //
2.25" (5.7 cm)
MODES //
High / Low / Flashing / Downcast
CERTIFICATIONS //
CI, D1



2780 HEADLAMP

LIGHT SOURCE //
LED
BATTERIES //
4 AA Alkaline (included)
LENGTH //
3.00" (7.6 cm)
MODES //
High / Medium /
Low / Flashing / Downcast/
Full-time Battery
Level Indicator

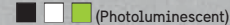

2780R HEADLAMP

LIGHT SOURCE //
LED
BATTERIES //
Lithium-Ion (included)
LENGTH //
3.00" (7.6 cm)
MODES //
High / Medium / Low /
Flashing / Downcast /
Full-time Battery
Level Indicator

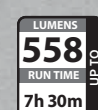
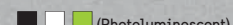

2785 HEADLAMP

LIGHT SOURCE //
LED
BATTERIES //
4 AA Alkaline (included)
LENGTH //
3.00" (7.6 cm)
MODES //
High / Medium / Low /
Flashing / Downcast
CERTIFICATIONS //
CI D1





RIGHT ANGLE / ARTICULATING LIGHTS

Firefighters put everything on the line and the correct lighting tools are critical. Right angle (90°) and adjustable head flashlights often worn on turnout coats offer hands-free performance. With extreme peak beam intensity and smoke-cutting penetration, these lights will get you in and out of tough situations safely.

3310R-RA

LIGHT SOURCE // LED
 BATTERIES // Lithium-Ion (included)
 LENGTH // 8.27" (21cm)
 MODES // Boost / High / Low



LUMENS
 RUN TIME
 UP TO
948
50h



3315R-RA

LIGHT SOURCE // LED
 BATTERIES // Lithium-Ion (included)
 LENGTH // 6.11" (15.5cm)
 CERTIFICATIONS // CI, D1



LUMENS
 RUN TIME
 UP TO
132
34h



3410 / 3410M

LIGHT SOURCE // LED
 BATTERIES // 3 AA (not included)
 LENGTH // 7.44" (18.9cm)
 MODES // High / Medium / Low
 Spot / Flood / Both



3410M Includes
 Magnetic Clip



LUMENS
 RUN TIME
 UP TO
653
61h

3415 / 3415M

LIGHT SOURCE // LED
 BATTERIES // 3 AA (not included)
 LENGTH // 7.44" (18.9cm)
 MODES // High
 Spot / Flood / Both



3415M Includes
 Magnetic Clip



LUMENS
 RUN TIME
 UP TO
336
14h

LITTLE ED™ 3610PL PHOTOLUMINESCENT SHROUD

LIGHT SOURCE // LED
 BATTERIES // 4 AA Alkaline (included)
 LENGTH // 7.51" (19.1cm)
 CERTIFICATIONS // CI II III, D1



LUMENS
 RUN TIME
 UP TO
183
5h 45m

LITTLE ED™ 3660

LIGHT SOURCE // LED
 BATTERIES // NiMH (included)
 LENGTH // 7.51" (19.1cm)
 CERTIFICATIONS // CI II, D2



LUMENS
 RUN TIME
 UP TO
183
5h

LITTLE ED™ 3610

LIGHT SOURCE // LED
 BATTERIES // 4 AA Alkaline (included)
 LENGTH // 7.51" (19.1cm)
 CERTIFICATIONS // CI II III, D1



LUMENS
 RUN TIME
 UP TO
183
5h 45m

3715

LIGHT SOURCE // LED
 BATTERIES // 4 AA Alkaline (not included)
 LENGTH // 5.36" (13.6cm)
 MODES // High / Low / Flashing / Downcast
 CERTIFICATIONS // CI, D1



LUMENS
 RUN TIME
 UP TO
233
31h



RIGHT ANGLE LIGHTS

RIGHT ANGLE LIGHTS



3715PL
PHOTOLUMINESCENT SHROUD

LIGHT SOURCE //
LED
BATTERIES //
4 AA Alkaline (not included)
LENGTH //
5.36" (13.6cm)
MODES //
High / Low / Flashing / Downcast
CERTIFICATIONS //
C1, D1



3765

LIGHT SOURCE //
LED
BATTERIES //
NiMH (included)
LENGTH //
5.36" (13.6cm)
MODES //
High / Low / Flashing / Downcast
CERTIFICATIONS //
C1, D1



3765 PL
PHOTOLUMINESCENT SHROUD

LIGHT SOURCE //
LED
BATTERIES //
NiMH (included)
LENGTH //
5.36" (13.6cm)
MODES //
High / Low / Flashing / Downcast
CERTIFICATIONS //
C1, D1



DIVE LIGHTS

Whether you'll be exploring underwater caves and crevices during daylight hours or enjoying the exhilarating adventure of a night dive, Pelican's Nemo™ line of dive lights will fill your needs. Designed to support depths up to 100 meters and built Pelican tough, you'll appreciate the reliability these underwater tools provide.



NEMO™ 1960N PHOTOLUMINESCENT SHROUD

LIGHT SOURCE //
LED
BATTERIES //
2 AAA Alkaline (included)
LENGTH //
5.48" (13.9cm)
SUBMERSIBLE //
100 Meters



LUMENS
34
RUN TIME
3h 30m



NEMO™ 2010N PHOTOLUMINESCENT SHROUD

LIGHT SOURCE //
LED
BATTERIES //
3 C Alkaline (not included)
LENGTH //
8.11" (20.6cm)
SUBMERSIBLE //
100 Meters



LUMENS
161
RUN TIME
22h



NEMO™ 2410N PHOTOLUMINESCENT SHROUD

LIGHT SOURCE //
LED
BATTERIES //
4 AA Alkaline (included)
LENGTH //
7" (17.8cm)
SUBMERSIBLE //
100 Meters



LUMENS
183
RUN TIME
5h 45m

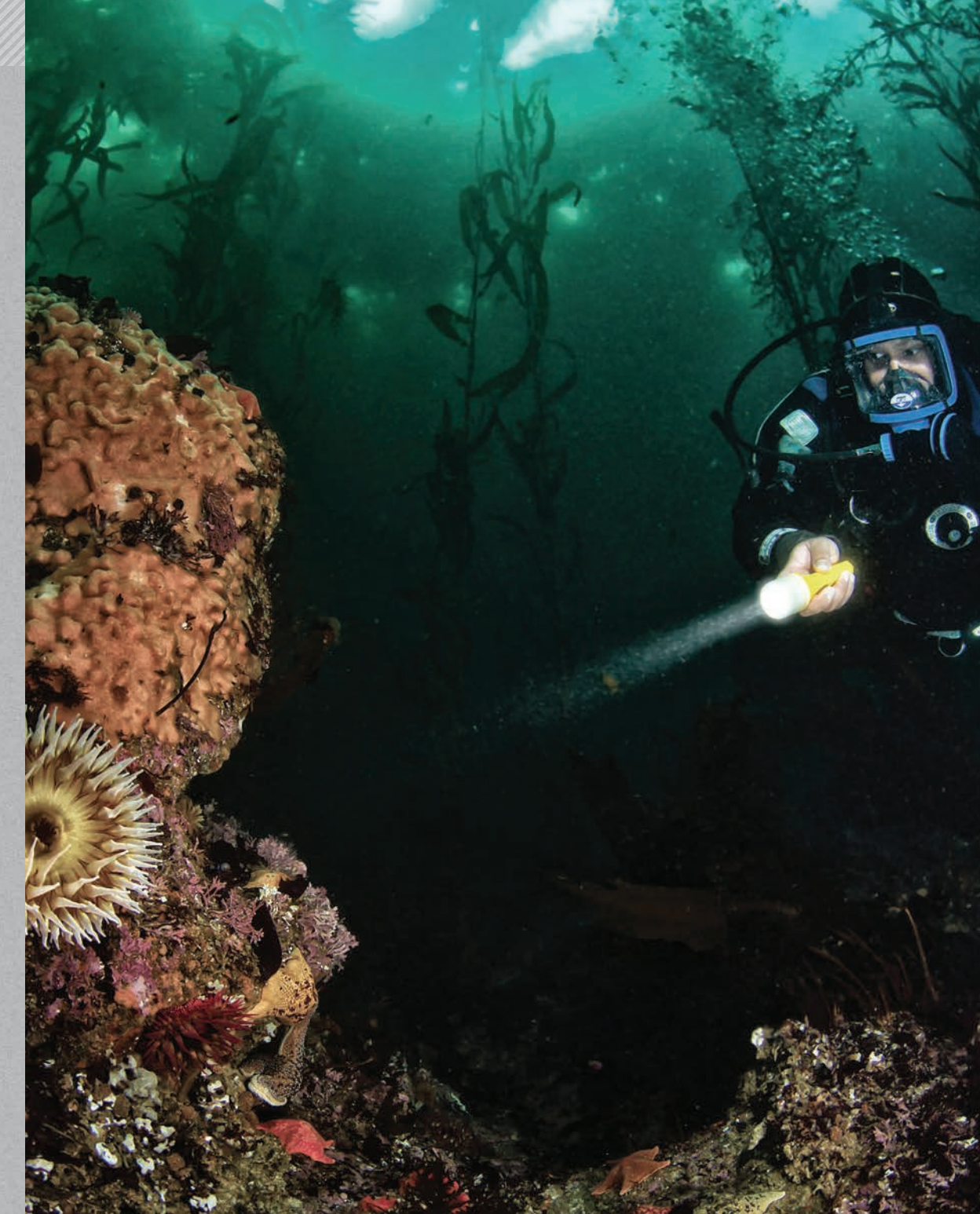

SPECIALTY LIGHTS

Whether directing fighter jets on the deck of aircraft carrier or protecting our troops with friend-or-foe infrared beacons, Pelican manufactures quality lighting tools for many unique military applications. Also available, magnetically secured flexible neck designs for mechanics and red LED flashers that are helpful in keeping workers safe.

MINI FLASHER™ 2130

LIGHT SOURCE // LED
 BATTERIES // 2 L1154 Alkaline (included)
 LENGTH // 1.73" (4.4 cm)



MINI FLASHER™ 2130IR

LIGHT SOURCE // LED (infrared)
 BATTERIES // 2 L1154 Alkaline (included)
 LENGTH // 1.73" (4.4 cm)



2365 FLEX NECK

LIGHT SOURCE // LED
 BATTERIES // 2 AA Alkaline (not included)
 LENGTH // 21.92" (55.7cm)



2490 (WITH TRAFFIC WAND)

LIGHT SOURCE // ReCoil™ LED
 BATTERIES // 4 AA Alkaline (not included)
 LENGTH // 12.5" (31.7 cm)



LIGHT WEAPON MOUNTING SYSTEMS



CAT. NO. 631

FOREGRIP MOUNT
Fits Pelican Light 7000.



CAT. NO. 7006

REMOTE PRESSURE SWITCH
Our tactical pressure switch replaces the standard tailcap on the flashlight. A 6" cord attached to a 2" pressure-sensitive switch mounts to the foregrip. Fits Pelican Light 7000 (Cat. No. 7006).
COLOR: Black // WT.: 2.0 oz.



NEW PELICAN™ HELMET HOLDERS BY BLACK JACK™ FLASHLIGHT HOLDER
Tough aluminum mounts are built to hold the flashlight under the brim of the helmet, parallel to the line of sight of the user.
Cat. No. #780, 781, 782



NEW PELICAN™ HEAD STRAP RETAINERS BY BLACK JACK™
Set of four high temperature composite clips that utilize a 3M™ adhesive and will attach to any helmet.
CAT. No. 783

LIGHT MOUNTING | HOLSTER | HOLDER STYLES

LIGHT MOUNTING | HOLSTER | HOLDER STYLES

	CAT. NO. 2327 Nylon Holster	CAT. NO. 2357/2367 Nylon Holster	CAT. NO. 2377 Nylon Holster	CAT. NO. 2407 Nylon Holster	CAT. NO. 7070RWH Nylon Holster / Wand Kit	Cat. NO. 7075 Basketweave Leather Holster	CAT. NO. 7077 Plain Leather Holster	Cat. NO. 7078 Nylon Holster	CAT. NO. 7106 Nylon Holster	CAT. NO. 7108 Composite Holster	CAT. NO. 7116 Nylon Holster	CAT. NO. 7606 Nylon Holster	CAT. NO. 7607 Nylon Holster / Wand Kit	CAT. NO. 7608 Composite Holster	CAT. NO. 7616 Nylon Holster	CAT. NO. 7617 Nylon Holster / Wand Kit	CAT. NO. 7627 Nylon Holster / Wand Kit	CAT. NO. 8057 Nylon Holster
HOLSTERS																		
CAT. NO.																		
2330	•																	
2360		•																
2370			•															
2410				•														
2410PL				•														
2460				•														
7000	•																	
7060						•	•	•										
7070R					•	•	•	•										
7100									•	•								
7110										•								
7600												•	•					
7610													•	•	•			
7620														•			•	
8050																		•

	CAT. NO. 700	CAT. NO. 750	CAT. NO. 770	CAT. NO. 780 FULL HOUSE	CAT. NO. 781 ACE	CAT. NO. 782 ALL IN	CAT. NO. 783 DOUBLE DOWN
HELMET HOLDERS							
CAT. NO.							
2330			•		•		
2350					•		
2360					•		
2370					•		
2410/PL	•	•	•	•			
2460	•	•	•	•			
3310			•			•	
3315/PL			•			•	
3325						•	
3330			•		•		
7000					•		
All Headlamps							•

SPECIFICATIONS

CAT. NO.	BATTERIES (included)	WEIGHT W/ BATTERIES (KG)	LENGTH (CM)	LUMENS	RUN TIME	BEAM SPREAD	NUMBER OF LED ^s	LAMP HEADS	CERTIFICATIONS	COLORS
9430	Rechargeable, Sealed Lead Acid	22.65 lbs. (10.27)	32.28" (82) ^A	3000*, 1500***	8h*, 15h***	125°	6	1	N/A	■ ■
9430SL	Rechargeable, Sealed Lead Acid	22.05 lbs. (10)	32.28" (82) ^A	2000*, 1000***	8h*, 15h***	10°	24	1	N/A	■
9440	Rechargeable Lithium ion	16.09 lbs. (7.3)	85" (215.8) ^A	5300*, 2800** 1400***	1h 30m*, 4h** 8h***	125°	12	1	N/A	■ ■
9455	Rechargeable NiMH	16 lbs. (7.3)	31.50" (80) ^A	1600*, 800***	5h*, 10h***	125°	10	1	CI D1, IECEx ia, ATEX Zone 0	■ ■
9460	Rechargeable, Sealed Lead Acid	61 lbs. (27.7)	79.50" (201.9) ^A	12,000 (variable)	3h*, 24h***	120°	10 per head	2	N/A	■ ■
9460M	Rechargeable, Sealed Lead Acid	64 lbs. (24.95)	79.50" (201.9) ^A	12,000 (variable)	3h*, 24h***	120°	10 per head	2	N/A	■ ■
9470	Rechargeable, Sealed Lead Acid	105 lbs. (47.6)	82.00" (208.3) ^A	24,000 (variable)	2h 45m*, 24h***	120°	10 per head	4	N/A	■ ■
9470M	Rechargeable, Sealed Lead Acid	108lbs. (49)	82.00" (208.3) ^A	24,000 (variable)	2h 45m*, 24h***	120°	10 per head	4	N/A	■ ■
9480	Rechargeable, Sealed Lead Acid	27.5 lbs. (12.47)	23.75" (60.3) ^A	4000*, 3000** 1000***	6h*, 8h** 28h***	125°	8	1	N/A	■ ■
9490	Rechargeable, Sealed Lead Acid	32 lbs. (14.51)	72" (182.8) ^A	6000 (variable)	3h 30m*, 12h** 24h***	125°	10	1	N/A	■ ■
9500	N/A	29.8 lbs. (13.52)	20.62" (52.4)	6000 (white LED) 1200 (red LED)	constant	210° (diffused)	36	3	N/A	■
9600	N/A	9.04 lbs. (4.1)	120" (304.8) ^A	3000	constant	125°	14	1	N/A	■

CAT. NO.	BATTERIES	WEIGHT W/ BATTERIES (KG)	LENGTH (CM)	ANSI LIGHT OUTPUT	ANSI RUN TIME	ANSI BEAM DISTANCE (meters)	ANSI PEAK BEAM INTENSITY (candela)	ANSI IPX RATING	CERTIFICATIONS	COLORS
5000	2 AAA Alkaline (included)	2.4 oz. (0.07)	5.59" (14.2)	202*, 21***	1h 15m*, 7h***	69*, 21***	1176*, 111***	IPX8	N/A	■
5010	2 AA Alkaline (included)	5.1 oz. (0.15)	6.26" (15.9)	392*, 22***	2h 15m*, 26h***	184*, 43***	8507*, 452***	IPX8	N/A	■
5020	4 AAA Alkaline (included)	7.3 oz. (0.21)	5.87" (14.9)	586*, 217**, 20***	1h*, 2h 30m**, 27h***	250*, 147**, 44***	15672*, 5368**, 480***	IPX8	N/A	■
5050R	Rechargeable Lithium-Ion (included)	5.8 oz. (0.16)	6.16" (15.6)	883 ^B , 393*, 21***	N/A ^B , 2h 30m*, 40h***	201 ^B , 134*, 30***	10093 ^B , 4488*, 224***	IPX8	N/A	■
2750CC	3 AAA Alkaline (included)	3.4 oz. (0.10)	2.25" (5.7)	183*, 50***	2h 30m*, 11h***	63*, 31***	989*, 240***	IPX4	N/A	■ (photoluminescent)
2755CC	3 AAA Alkaline (included)	3.4 oz. (0.10)	2.25" (5.7)	72*, 36***	6h 45m*, 15h***	50*, 35***	632*, 302***	IP54	CI D1, IECEx ia	■
3310CC	3 AA Alkaline (included)	6.2 oz. (0.18)	6.14" (15.6)	283*, 31***	8h*, 175h***	169*, 50***	7150*, 625***	IPX8	N/A	■ (photoluminescent)
3315CC	3 AA Alkaline (included)	6.2 oz. (0.18)	6.14" (15.6)	130	16h 30m	110	3042	IP67	CI II III, D1, IECEx ia	■
3410MCC	3 AA Alkaline (not included)	9.2 oz. (0.26)	7.44" (18.9)	484*, 64**, 17***	4h*, 20h**, 67h***	155*, 56**, 29***	5991*, 796**, 205***	IPX8	N/A	■ (photoluminescent)
3415MCC	3 AA Alkaline (not included)	9.0 oz. (0.26 gr)	7.44" (18.9)	258 ^{S/F} , 127 ^F , 144 ^S	5h ^{S/F} , 13h ^F , 13h ^S	111 ^{S/F} , 30 ^F , 109 ^S	3109 ^{S/F} , 231 ^F , 2998 ^S	IPX8	CI II III, D1, IECEx ia	■

*High | **Medium | ***Low | ****Downcast | ^A Extended Height | ^B Boost | ^S Spot | ^F Flood | Additional approvals may apply.

CAT. NO.	BATTERIES	WEIGHT W/ BATTERIES (KG)	LENGTH (CM)	ANSI LIGHT OUTPUT	ANSI RUN TIME	ANSI BEAM DISTANCE (meters)	ANSI PEAK BEAM INTENSITY (candela)	ANSI IPX RATING	CERTIFICATIONS	COLORS
1810	4 LR 41 Alkaline (included)	0.5 oz. (0.01)	1.5" (3.8)	16	8h 30m	23	137	IPX4	N/A	■ ■ ■
1830	3 AAAA Alkaline (included)	1.2 oz. (0.03)	6.2" (15.7)	5	32h	13	44	IPX4	CI, D1	■ ■
1910	1 AAA Alkaline (included)	1.5 oz. (0.04)	3.8" (9.6)	106*, 21***	2h 30m*, 4h***	55*, 24***	765*, 140***	IPX7	N/A	■ ■ ■
1920	2 AAA Alkaline (included)	2.2 oz. (0.06)	5.5" (14)	224*, 22***	2h 15m*, 8h 45m***	81*, 25***	1640*, 152***	IPX7	N/A	■ ■ ■
1930	4 LR 44 Alkaline (included)	0.9 oz. (0.03)	2.64" (6.7)	12	4h 15m	17	70	IPX4	CI, D1/CII, D2	■ ■
1965	2 AAA Alkaline (included)	1.9 oz. (0.05)	5.48" (13.9)	87	2h 15m	41	429	IPX7	CI II III, D1	■ ■
1970	2 AAA Alkaline (included)	1.8 oz. (0.05)	5.75" (14.6)	139	4h 15m	29	205	IPX4	N/A	■
1975	2 AAA Alkaline (included)	1.9 oz. (0.05)	5.75" (14.6)	117	2h 15m	24	141	IPX4	CI II III, D1	■
2220	2 CR2032 Lithium (included)	1 oz. (0.03)	3.5" (8.9)	9	34h	12	38	IPX4	CI, D1	■ ■ ■
2010	3 C Alkaline (not included)	13.4 oz. (0.38)	8.11" (20.6)	161	22h	160	6398	IPX7	CI II III, D1	■ ■
2010PL	3 C Alkaline (not included)	13.4 oz. (0.38)	8.11" (20.6)	161	22h	160	6398	IPX7	CI II III, D1	■
2410	4 AA Alkaline (included)	7.3 oz. (0.21)	7" (17.8)	183	5h 45m	184	8480	IPX7	CI II III, D1	■ ■
2410PL	4 AA Alkaline (included)	7.3 oz. (0.21)	7" (17.8)	183	5h 45m	184	8480	IPX7	CI II III, D1	■
2460	Rechargeable NiMH (included)	7.8 oz. (0.22)	7" (17.8)	183	5h	179	8050	IPX7	CI II, D2	■ ■
3310PL	3 AA Alkaline (included)	6.2 oz. (0.18)	6.14" (15.6)	378*, 39***	8h*, 202h***	196*, 62***	9580*, 961***	IPX8	N/A	■ (photoluminescent)
3310ELS	3 AA Alkaline (included)	6.2 oz. (0.18)	6.14" (15.6)	378*, 39***	8h*, 202h***	196*, 62***	9580*, 961***	IPX8	N/A	■ (photoluminescent)
3310R	Rechargeable Lithium-Ion (included)	5.4 (0.15)	6.11" (15.5)	1067 ^B , 403*, 21***	N/A ^B , 2h 30m*, 50h***	243 ^B , 149*, 34***	14808 ^B , 5591*, 281***	IPX8	N/A	■ ■
3315	3 AA Alkaline (included)	6.2 oz. (0.18)	6.14" (15.6)	160	19h	144	5153	IPX7	CI II III, D1	■ ■
3315R	Rechargeable Lithium-Ion (included)	6.2 oz. (0.18)	6.11" (15.5)	132*, 15***	5h*, 34h***	108*, 35***	2931*, 308***	IPX7	CI, D1	■ ■
3315PL	3 AA Alkaline (included)	6.2 oz. (0.18)	6.14" (15.6)	160	19h	144	5153	IPX7	CI II III, D1	■ (photoluminescent)
3325	3 AA Alkaline (included)	6.1 oz. (0.17)	6.06" (15.4)	162	16h	144	5215	IPX7	CI, D1	■
3345	3 AA Alkaline (not included)	7.5 oz. (0.21)	7.25" (18.4)	280 ^{S/F} , 117 ^F , 219 ^S	5h ^{S/F} , 13h 15m ^F , 9h ^S	126 ^{S/F} , 16 ^F , 137 ^S	3990 ^{S/F} , 60 ^F , 4724 ^S	IPX7	CI II III, D1	■

*High | **Medium | ***Low | ****Downcast | ^B Boost | ^S Spot | ^F Flood | Additional approvals may apply.

	CAT NO.	BATTERIES	WEIGHT W/ BATTERIES (KG)	LENGTH (CM)	ANSI LIGHT OUTPUT	ANSI RUN TIME	ANSI BEAM DISTANCE (meters)	ANSI PEAK BEAM INTENSITY (candela)	ANSI IPX RATING	CERTIFICATIONS	COLORS	
LARGE LIGHTS	9410L	Rechargeable Lithium-Ion (included)	44.7 oz. (1.27)	8.75" (22.2)	2207*, 463***	3h 15m*, 11h***	453*, 207***	51,304*, 10,710***	IPX4	N/A	■ ■	
	9415	Rechargeable NiMH (included)	49.3 oz. (1.4)	8.75" (22.2)	413*, 159***	4h 30m*, 12h***	325*, 201***	26352*, 10076***	IPX4	CI, D1	■	
	2350	1 AA Alkaline (included)	3.4 oz. (0.1)	4.23" (10.7)	178*, 15***	2h 15m*, 21h***	130*, 37***	4196*, 345***	IPX7	N/A	■	
TACTICAL LIGHTS	2360	2 AA Alkaline (included)	5.4 oz. (0.15)	6.2" (15.7)	375*, 29***	2h 30m*, 13h***	192*, 53***	9187*, 705***	IPX8	N/A	■	
	2370	2 AA Alkaline (included)	6.5 oz. (0.18)	6.43" (16.3)	358*, 35***	2h*, 11h***	158*, 52***	9000*, 823***	IPX7	N/A	■	
	3330	2 CR123 Lithium (included)	3.45 oz. (0.1)	5.27" (13.4)	90	4h 45m	88	1959	IPX4	N/A	■ ■	
	7000	2 CR123 Lithium (included)	5.6 oz. (0.16)	5.31" (13.5)	774*, 457** , 99***	1h 15m*, 1h 45m**, 13h***	246*, 176** , 83***	14768*, 7712** , 1738***	IPX7	N/A	■	
	7060	Rechargeable Lithium-Ion (included)	10.4 oz. (0.29)	8.65" (22)	402*, 162** , 18***	3h 30m*, 12h** , 57h***	210*, 131** , 45***	11078*, 4312** , 500***	IPX4	N/A	■	
	7070R	Rechargeable Lithium-Ion (included)	7.9 oz. (0.22)	6.88" (17.5)	1219*, 626** , 32***	2h 15m*, 4h 15m** , 32h***	235*, 168** , 40***	13872*, 7066** , 400***	IPX8	N/A	■	
	7100	Rechargeable Lithium-Ion (included)	4.4 oz. (0.13)	5.12" (13)	695*, 348** , 33***	1h 15m*, 1h 30m** , 9h 15m***	194*, 130** , 38***	9314*, 4247** , 358***	IPX8	N/A	■	
	7110	1 AA Alkaline (included) or 1 CR123	4.1 oz. (0.12)	4.63" (11.8)	445*, 214** , 23***	1h*, 1h 30m** , 13h***	93*, 62** , 20***	6053*, 2695** , 288***	IPX8	N/A	■	
	7600	Rechargeable Lithium-Ion (included)	7.1 oz. (0.20)	6.19" (15.7)	944*, 479** , 37***	3h 15m*, 4h 30m** , 29h***	225*, 157** , 44***	12693*, 6172** , 480***	IPX8	N/A	■	
	7610	1 AA Alkaline (included) or 2 CR123	5.5 oz. (0.16)	5.44" (13.8)	1018*, 531** , 25***	1h 30m*, 2h** , 33h***	227*, 151** , 33***	12856*, 5674** , 273***	IPX8	N/A	■	
	7620	2 AA Alkaline (included) or 3 CR123	6.9 oz. (0.20)	6.75" (17.1)	1124*, 528** , 28***	2h*, 3h** , 37h***	243*, 155** , 35***	14824*, 5974** , 315***	IPX8	N/A	■	
	8060	Rechargeable NiMH (included)	23.2 oz. (0.66)	12.67" (32.2)	803*, 447** , 25***	2h 30m*, 4h** , 69h***	359*, 265** , 62***	32252*, 17492** , 958***	IPX4	N/A	■	
	HEAD LAMPS	2610	3 AAA Alkaline (included)	3.2 oz. (0.09)	1.49" (3.8)	30*, 14***	19h*, 47h***	28*, 19***	194*, 91***	IPX4	CI, D1	■
		2690	3 AAA Alkaline (included)	4.1 oz. (0.12)	2.81" (7.1)	74	11h	92	2124cd	IPX7	CI II III, D1	■
		2720	3 AAA Alkaline (included)	3.8 oz. (0.11)	2.48" (6.3)	200*, 12***	3h*, 103h***	82*, 20***	1684*, 103***	IPX4	N/A	■
2740		3 AAA Alkaline (included)	3.3 oz. (0.09)	2.25" (5.7)	66*, 36***	7h 15m*, 21h***	22*, 16***	122*, 68***	IPX4	N/A	■ ■ (translucent)	
2745		3 AAA Alkaline (included)	3.3 oz. (0.09)	2.25" (5.7)	33*, 17***	20h*, 40h***	35* , 25***	309*, 155***	IPX4	CI, D1	■ ■	
2750		3 AAA Alkaline (included)	3.4 oz. (0.1)	2.25" (5.7)	193*, 63***	3h*, 11h***	98*, 58***	1250* , 591***	IPX4	N/A	■ ■ (photoluminescent)	
2755		3 AAA Alkaline (included)	3.4 oz. (0.1)	2.25" (5.7)	72*, 34***	6h*, 15***	57*, 40***	807* , 404***	IPX4	CI, D1	■ ■	

*High | **Medium | ***Low | ****Downcast | Additional approvals may apply.

	CAT NO.	BATTERIES	WEIGHT W/ BATTERIES (KG)	LENGTH (CM)	ANSI LIGHT OUTPUT	ANSI RUN TIME	ANSI BEAM DISTANCE (meters)	ANSI PEAK BEAM INTENSITY (candela)	ANSI IPX RATING	CERTIFICATIONS	COLORS
HEAD LAMPS	2760	3 AAA Alkaline (included)	3.4 oz. (0.1)	2.25" (5.7)	204*, 141** , 95*** , 42****	2h*, 3h 15m** , 5h*** , 11h****	111*, 80** , 59*** , 19****	3065*, 1606** , 861*** , 88****	IPX4	N/A	■ ■ (translucent)
	2765	3 AAA Alkaline (included)	3.4 oz. (0.1)	2.25" (5.7)	105*, 104** , 65*** , 33****	4h 15m*, 4h** , 6h 15m*** , 9h****	107*, 93** , 63*** , 9****	2876*, 2163** , 978*** , 18****	IPX4	CI, D1	■ ■
	2780	4 AA Alkaline (included)	250 oz. (7.09)	3" (7.6)	430*, 203** , 53***	1h 30m*, 3h** , 12h***	127*, 81** , 27***	3868*, 1625** , 425***	IPX7	N/A	■ ■ (photoluminescent)
	2780R	Rechargeable Lithium-Ion (included)	250 oz. (7.09)	3" (7.6)	558*, 213** , 95***	2h*, 3h** , 7h 30m***	127*, 78** , 53***	4060*, 1540** , 695***	IPX7	N/A	■ ■ (photoluminescent)
	2785	4 AA Alkaline (included)	250 oz. (7.09)	3" (7.6)	226*, 103** , 33***	5h 45m*, 20h** , 66h***	111*, 74** , 41***	3058*, 1372** , 417***	IPX7	CI, D1	■ ■
RIGHT ANGLE LIGHTS	3310R-RA	Rechargeable Lithium-Ion (included)	5.4 (0.15)	8.27" (21)	948 ^B , 385*, 20***	N/A ^S , 2h 30m*, 50h***	236 ^B , 147*, 32***	13944 ^B , 5424* , 267***	IPX8	N/A	■
	3315R-RA	Rechargeable Lithium-Ion (included)	6.2 oz. (0.18)	6.11" (15.5)	132*, 15***	5h*, 34h***	108*, 35***	2931*, 308***	IPX7	N/A	■
	3410 / 3410M	3 AA Alkaline (not included)	9.2 oz. (0.26)	7.44" (18.9)	653*, 97** , 25***	5h*, 19h* , 61h*	184*, 67** , 34***	8504*, 1129** , 292***	IPX8	N/A	■ (photoluminescent)
	3415 / 3415M	3 AA Alkaline (not included)	9.0 oz. (0.25)	7.44" (18.9)	336 ^{S/F} , 177 ^F , 186 ^S	6h ^{S/F} , 15h ^F , 14h ^S	133 ^{S/F} , 37 ^F , 135 ^S	4418 ^{S/F} , 336 ^F , 4544 ^S	IPX8	CI II III, D1	■
	3610	4 AA Alkaline (included)	10.5 oz. (0.3)	7.51" (19.1)	183	5h 45m	184	8480	IPX7	CI II III, D1	■ ■
	3610PL	4 AA Alkaline (included)	10.5 oz. (0.3)	7.51" (19.1)	183	5h 45m	184	8480	IPX7	CI II III, D1	■
	3660	Rechargeable 4 AA NiMH (included)	10.56 oz. (0.3)	7.51" (19.1)	183	5h	153	5828	IPX7	CI II, D2	■ ■
	3715	4 AA Alkaline (not included)	14.4 oz. (0.41)	5.36" (13.6)	233*, 113*** , 31****	4h*, 7h*** , 31h****	293*, 187*** , 30****	21440*, 8775*** , 220****	IPX4	CI, D1	■ ■
	3715PL	4 AA Alkaline (not included)	14.4 oz. (0.41)	5.36" (13.6)	233*, 113*** , 31****	4h*, 7h*** , 31h****	293*, 187*** , 30****	21440*, 8775*** , 220****	IPX4	CI, D1	■
	3765	Rechargeable NiMH (included)	14.6 oz. (0.41)	5.36" (13.6)	237*, 113*** , 32****	3h*, 6h 30m*** , 14h****	301*, 193*** , 28****	22720*, 9354*** , 192****	IPX4	CI, D1	■ ■
DIVE LIGHTS	3765PL	Rechargeable NiMH (included)	14.6 oz. (0.41)	5.36" (13.6)	237*, 113*** , 32****	3h*, 6h 30m*** , 14h****	301*, 193*** , 28****	22720*, 9354*** , 192****	IPX4	CI, D1	■
	1960N	2 AAA Alkaline (included)	1.9 oz. (0.05)	5.48" (13.9)	34	3h 30m	42	450	IPX8	N/A	■ ■ ■
	2010N	3 C Alkaline (not included)	13.4 oz. (0.38)	8.11" (20.6)	161	22h	260	6398	IPX8	N/A	■ ■ ■
	2410N	4 AA Alkaline (included)	7.3 oz. (0.21)	7" (17.8)	183	5h 45m	184	8480	IPX8	N/A	■ ■ ■
	2130	2 L1154 Alkaline (included)	0.5 oz. (0.01)	1.73" (4.4)	4.7 (non ANSI)	130h (non ANSI)	N/A	N/A	IPX7	N/A	■
	2130IR	2 L1154 Alkaline (included)	0.5 oz. (0.01)	1.73" (4.4)	N/A	65h (non ANSI)	N/A	N/A	IPX7	N/A	■
	2365	2 AA Alkaline (not included)	9.3 oz. (0.26)	21.92" (55.7)	65	7h	81	1644	IPX4	N/A	■
SPECIALTY LIGHTS	2490	4 AA Alkaline (not included)	8.2 oz. (0.23)	12.5" (31.7)	64	12h	118	3459	IPX7	N/A	□

*High | **Medium | ***Low | ****Downcast | ^B Boost | ^S Spot | ^F Flood | Additional approvals may apply.

CUSTOM LABELS

Pelican Products offers the ultimate in private labeling. You can put your company name and logo or a special statement on many Pelican lights. Our in-house private label molding and production department has complete short and long run capabilities for a variety of custom applications and custom colors. We have the latest hot stamping equipment, utilizing the world's most durable inks and foils in our screening, hot tipping, embossing, and molding programs. Laser etching is also available for many of the metal bodied lights



GRAPHIC DESIGN STUDIO
Our in-house graphics studio will take your logo and size it appropriately to the flashlight of your choice.



HOT STAMPING
Our hot stamping department is equipped with the latest technology in custom imprinting. Minimum quantities apply.



LASER ETCHING
Available only on metal bodied lights.

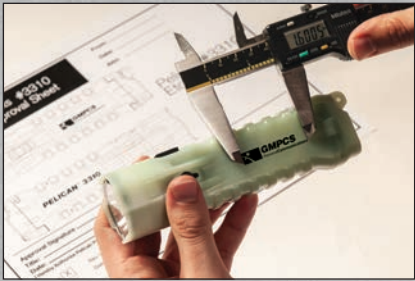

100% ACCURACY
Pelican's strict QA inspection team will check for quality of print and 100% accuracy in color and placement.



SINGLE LID SIZE LIST

OCT 2017 | Rev. 1

MADE IN
USA

SINCE 1976

SINGLE LID SIZE LIST

OCT 2017 | Rev. 1

SINGLE LID CASE MEASUREMENT GUIDE



Dimensions are nominal. Weights approximate.

PARTING - LINE WIDTH

- AL =1.5" (38mm)
- BL =2.0" (51mm)
- CL =1.0" (25mm)
- DL =1.75" (44mm)

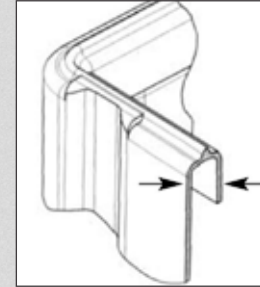

CASE SIZE PART NUMBERS

AL 36 27 - 08 05 FT/AC/HL/DE

- FT (fork truckable)
- AC (all catch)
- HL (handle on lid)
- DE (stacking ribs match Classic Racks)

Lid = Case Lid Height
 Base = Case Base Height
 W = Case Width
 L = Case Length
 Parting Line Width

CASE SIZE TOLERANCES

Dimension Range in Inches	Tolerance in Inches
1 to 5.99	±0.12 (1/8")
6 to 36.99	±0.19 (3/16")
37 to 72.99	±0.25 (1/4")
73 to 90.99	±0.31 (5/16")
91 to 108.99	±0.38 (3/8")
109 to 134.00	±0.44 (7/16")

Weights shown is the empty container weight, with handles and hardware in the standard configuration.
 Outside dims do not include a box.

SINGLE LID SIZE LIST

OCT 2017 | Rev. 1

CASE SIZE	INSIDE DIMENSIONS						EXTERIOR DIMENSIONS											
	L		W		H		BASE		LID		L		W		H		WEIGHT	
	in	(mm)	in	(mm)	in	(mm)	in	(mm)	in	(mm)	in	(mm)	in	(mm)	in	(mm)	lbs	(kg)
AL1010-0904	9.93	(252)	10.00	(254)	12.70	(323)	8.7	(221)	4	(102)	12.93	(328)	13.00	(330)	14.39	(366)	9.80	(7)
AL1010-0905	9.93	(252)	10.00	(254)	13.95	(354)	8.7	(221)	5.3	(133)	12.93	(328)	13.00	(330)	15.64	(397)	10.00	(7)
AL1010-1404	9.93	(252)	10.00	(254)	17.75	(451)	13.8	(349)	4	(102)	13.00	(330)	13.00	(330)	19.44	(494)	11.50	(9)
AL1010-1405	9.93	(252)	10.00	(254)	19.00	(483)	13.8	(349)	5.3	(133)	12.93	(328)	13.00	(330)	20.69	(526)	12.40	(9)
CL1109-0303HL	11.00	(279)	8.87	(225)	6.00	(152)	3	(76)	3	(76)	13.12	(333)	10.87	(276)	8.19	(208)	5.40	(4)
AL1212-0604	12.00	(305)	12.00	(305)	10.31	(262)	6.3	(160)	4	(102)	15.00	(381)	15.00	(381)	12.00	(305)	11.00	(5)
AL1212-0605	12.00	(305)	12.00	(305)	11.31	(287)	6.3	(160)	5.1	(130)	15.00	(381)	15.00	(381)	13.00	(330)	11.20	(6)
AL1212-0404	12.00	(305)	12.00	(305)	8.21	(209)	4.2	(107)	4	(102)	15.00	(381)	15.00	(381)	9.90	(251)	9.50	(4)
AL1212-0405	12.00	(305)	12.00	(305)	9.33	(237)	4.2	(107)	5.1	(130)	15.00	(381)	15.00	(381)	11.02	(280)	9.70	(5)
AL1212-1204	12.00	(305)	12.00	(305)	15.27	(388)	11.3	(286)	4	(102)	15.00	(381)	15.00	(381)	16.96	(431)	12.80	(8)
AL1212-1205	12.00	(305)	12.00	(305)	16.39	(416)	11.3	(286)	5.1	(130)	15.00	(381)	15.00	(381)	18.08	(459)	13.10	(8)
AL1212-1504	12.00	(305)	12.00	(305)	19.18	(487)	15.2	(386)	4	(102)	15.00	(381)	15.00	(381)	20.87	(530)	14.70	(9)
AL1212-1505	12.00	(305)	12.00	(305)	20.30	(516)	15.2	(386)	5.1	(130)	15.00	(381)	15.00	(381)	21.99	(559)	14.90	(10)
AL1212-1904	12.00	(305)	12.00	(305)	22.70	(577)	18.7	(475)	4	(102)	15.00	(381)	15.00	(381)	24.39	(620)	16.80	(11)
AL1212-1905	12.00	(305)	12.00	(305)	23.82	(605)	18.7	(475)	5.1	(130)	15.00	(381)	15.00	(381)	25.51	(648)	17.00	(12)
CL1412-0502	14.75	(375)	11.87	(301)	7.43	(189)	4.9	(125)	2.5	(64)	16.87	(428)	13.87	(352)	8.44	(214)	9.40	(4)
AL1413-0505	14.50	(368)	13.12	(333)	10.30	(262)	5.1	(129)	5.2	(133)	17.50	(445)	16.12	(409)	11.99	(305)	13.50	(5)
AL1413-1005	14.50	(368)	13.12	(333)	15.42	(392)	10.2	(259)	5.2	(133)	17.50	(445)	16.12	(409)	17.11	(435)	16.50	(8)
AL1413-2105	14.50	(368)	13.12	(333)	25.99	(660)	20.8	(527)	5.2	(133)	17.50	(445)	16.12	(409)	27.69	(703)	19.70	(13)
AL1414-0705	14.00	(356)	14.12	(359)	11.93	(303)	6.8	(171)	5.2	(132)	17.00	(432)	17.12	(435)	13.61	(346)	14.50	(6)
AL1616-0404	15.75	(400)	15.88	(403)	7.74	(197)	3.9	(98)	3.9	(98)	18.75	(476)	18.88	(480)	9.43	(240)	12.60	(4)
AL1616-0405	15.75	(400)	15.88	(403)	8.99	(228)	3.9	(98)	5.1	(130)	18.75	(476)	18.88	(480)	10.69	(272)	13.70	(5)
AL1616-0412	15.75	(400)	15.88	(403)	16.05	(408)	3.9	(98)	12.2	(309)	18.75	(476)	18.88	(480)	17.69	(449)	17.90	(8)
AL1616-0504	15.75	(400)	15.88	(403)	9.29	(236)	5.4	(138)	3.9	(98)	18.75	(476)	18.88	(480)	10.98	(279)	13.90	(5)
AL1616-0505	15.75	(400)	15.88	(403)	10.54	(268)	5.4	(138)	5.1	(130)	18.75	(476)	18.88	(480)	12.19	(310)	14.50	(6)
AL1616-0512	15.75	(400)	15.88	(403)	17.60	(447)	5.4	(138)	12.2	(309)	18.75	(476)	18.88	(480)	19.19	(487)	18.50	(9)
AL1616-1004	15.75	(400)	15.88	(403)	13.74	(349)	9.9	(251)	3.9	(98)	18.75	(476)	18.88	(480)	15.43	(392)	17.20	(7)
AL1616-1005	15.75	(400)	15.88	(403)	14.99	(381)	9.9	(251)	5.1	(130)	18.75	(476)	18.88	(480)	16.69	(424)	17.60	(8)
AL1616-1012AC/HL	15.75	(400)	15.88	(403)	22.05	(560)	9.9	(251)	12.2	(309)	18.75	(476)	18.88	(480)	23.69	(602)	22.40	(11)
AL1616-1204	15.75	(400)	15.88	(403)	15.20	(386)	11.3	(288)	3.9	(98)	18.75	(476)	18.88	(480)	16.89	(429)	17.90	(8)
AL1616-1205	15.75	(400)	15.88	(403)	16.45	(418)	11.3	(288)	5.1	(130)	18.75	(476)	18.88	(480)	18.14	(461)	18.60	(8)

Weights shown is the empty container weight, with handles and hardware in the standard configuration.
Outside dims do not include a box.

SINGLE LID SIZE LIST

OCT 2017 | Rev. 1

CASE SIZE	INSIDE DIMENSIONS						EXTERIOR DIMENSIONS											
	L		W		H		BASE		LID		L		W		H		WEIGHT	
	in	(mm)	in	(mm)	in	(mm)	in	(mm)	in	(mm)	in	(mm)	in	(mm)	in	(mm)	lbs	(kg)
AL1616-1212AC	15.75	(400)	15.88	(403)	23.51	(597)	11.3	(288)	12.2	(309)	18.75	(476)	18.88	(480)	25.19	(640)	23.20	(11)
AL1616-1804	15.75	(400)	15.88	(403)	22.12	(562)	18.3	(464)	3.9	(98)	18.75	(476)	18.88	(480)	23.81	(605)	21.70	(11)
AL1616-1805	15.75	(400)	15.88	(403)	23.37	(594)	18.3	(464)	5.1	(130)	18.75	(476)	18.88	(480)	25.07	(637)	22.00	(11)
AL1616-1812AC	15.75	(400)	15.88	(403)	30.43	(773)	18.3	(464)	12.2	(309)	18.75	(476)	18.88	(480)	32.12	(816)	26.90	(15)
CL1713-0403	16.88	(429)	12.88	(327)	7.38	(187)	4.4	(111)	3	(76)	19.00	(483)	14.88	(378)	9.07	(230)	6.80	(4)
CL1713-0408AC/HL	16.88	(429)	12.88	(327)	12.00	(305)	4.4	(111)	7.6	(194)	19.00	(483)	14.88	(378)	13.69	(348)	11.00	(6)
CL1715-0904	17.12	(435)	14.87	(378)	14.02	(356)	9.9	(251)	4.2	(105)	19.25	(489)	16.87	(428)	15.69	(399)	12.60	(7)
AL1717-0909AC	17.00	(432)	17.00	(432)	17.86	(454)	8.9	(225)	9	(229)	20.00	(508)	20.00	(508)	19.55	(497)	18.80	(9)
AL1814-0504	18.00	(457)	14.62	(371)	9.11	(231)	5.2	(132)	3.9	(100)	21.00	(533)	17.62	(448)	10.80	(274)	14.40	(5)
AL1814-0505	18.00	(457)	14.62	(371)	10.38	(264)	5.2	(132)	5.2	(132)	21.00	(533)	17.62	(448)	12.05	(306)	15.60	(5)
AL1814-1504	18.00	(457)	14.62	(371)	18.86	(479)	14.9	(379)	3.9	(100)	21.00	(533)	17.62	(448)	20.55	(522)	19.30	(9)
AL1814-1505	18.00	(457)	14.62	(371)	20.13	(511)	14.9	(379)	5.2	(132)	21.00	(533)	17.62	(448)	21.82	(554)	20.50	(10)
AL1814-2204	18.00	(457)	14.62	(371)	26.11	(663)	22.2	(563)	3.9	(100)	21.00	(533)	17.62	(448)	27.80	(706)	23.40	(13)
AL1814-2205	18.00	(457)	14.62	(371)	27.38	(695)	22.2	(563)	5.2	(132)	21.00	(533)	17.62	(448)	29.07	(738)	24.60	(13)
AL1818-0603	17.93	(455)	17.93	(455)	9.55	(243)	6.4	(162)	3.2	(81)	20.93	(532)	20.93	(532)	11.25	(286)	16.50	(5)
CL2012-0902	20.18	(513)	11.75	(298)	11.66	(296)	9.2	(233)	2.5	(64)	22.30	(566)	13.75	(349)	13.35	(339)	12.20	(6)
AL2013-0403	19.87	(505)	13.00	(330)	7.00	(178)	4	(102)	3	(76)	22.87	(581)	16.00	(406)	8.69	(221)	13.50	(4)
AL2013-0903	19.87	(505)	13.00	(330)	12.25	(311)	9.3	(235)	3	(76)	22.87	(581)	16.00	(406)	13.94	(354)	16.80	(6)
AL2015-0503HL	19.75	(502)	15.62	(397)	7.81	(198)	5.1	(129)	2.8	(70)	22.75	(578)	18.62	(473)	9.49	(241)	16.50	(4)
AL2015-1503HL	19.75	(502)	15.62	(397)	17.95	(456)	15.2	(386)	2.8	(70)	22.75	(578)	18.62	(473)	19.64	(499)	24.10	(9)
AL2017-0706	20.24	(514)	17.15	(436)	13.00	(330)	7	(178)	6	(152)	23.24	(590)	20.15	(512)	14.82	(376)	19.10	(7)
AL2020-1305	19.87	(505)	19.87	(505)	18.11	(460)	12.9	(328)	5.2	(132)	22.87	(581)	22.87	(581)	19.80	(503)	25.70	(9)
AL2216-0503	22.00	(559)	16.00	(406)	8.25	(210)	5.3	(133)	3	(76)	25.00	(635)	19.00	(483)	10.19	(259)	17.50	(5)
AL2216-0505	22.00	(559)	16.00	(406)	10.50	(267)	5.3	(133)	5.3	(133)	25.00	(635)	19.00	(483)	12.19	(310)	18.50	(6)
AL2216-0803	22.00	(559)	16.00	(406)	11.43	(290)	8.4	(214)	3	(76)	25.00	(635)	19.00	(483)	13.37	(340)	19.00	(6)
AL2216-0805	22.00	(559)	16.00	(406)	13.68	(347)	8.4	(214)	5.3	(133)	25.00	(635)	19.00	(483)	15.37	(390)	20.00	(7)
AL2216-1203	22.00	(559)	16.00	(406)	15.25	(387)	12.3	(311)	3	(76)	25.00	(635)	19.00	(483)	17.19	(437)	21.10	(8)
AL2216-1205	22.00	(559)	16.00	(406)	17.50	(445)	12.3	(311)	5.3	(133)	25.00	(635)	19.00	(483)	19.19	(487)	22.10	(9)
AL2221-0402	22.50	(572)	21.06	(535)	6.15	(156)	3.9	(99)	2.3	(57)	25.50	(648)	24.06	(611)	8.31	(211)	21.20	(4)
AL2221-0404	22.50	(572)	21.06	(535)	7.65	(194)	3.9	(99)	3.8	(95)	25.50	(648)	24.06	(611)	9.80	(249)	22.40	(4)
AL2221-0405	22.50	(572)	21.06	(535)	8.90	(226)	3.9	(99)	5	(127)	25.50	(648)	24.06	(611)	11.00	(279)	23.30	(5)

Weights shown is the empty container weight, with handles and hardware in the standard configuration.
Outside dims do not include a box.

SINGLE LID SIZE LIST

OCT 2017 | Rev. 1

CASE SIZE	INSIDE DIMENSIONS						EXTERIOR DIMENSIONS											
	L		W		H		BASE		LID		L		W		H		WEIGHT	
	in	(mm)	in	(mm)	in	(mm)	in	(mm)	in	(mm)	in	(mm)	in	(mm)	in	(mm)	lbs	(kg)
AL2221-0414AC/HL	22.50	(572)	21.06	(535)	18.15	(461)	3.9	(99)	14.3	(362)	25.50	(648)	24.06	(611)	20.20	(513)	30.10	(9)
AL2221-0419DE	22.50	(572)	21.06	(535)	23.62	(600)	4	(102)	19.6	(498)	25.50	(648)	24.06	(611)	25.31	(643)	32.00	(11)
AL2221-0602	22.50	(572)	21.06	(535)	8.75	(222)	6.5	(165)	2.3	(57)	25.50	(648)	24.06	(611)	10.44	(265)	22.80	(5)
AL2221-0604	22.50	(572)	21.06	(535)	10.25	(260)	6.5	(165)	3.8	(95)	25.50	(648)	24.06	(611)	11.94	(303)	24.00	(5)
AL2221-0605	22.50	(572)	21.06	(535)	11.50	(292)	6.5	(165)	5	(127)	25.50	(648)	24.06	(611)	13.13	(334)	24.80	(6)
AL2221-0614AC/HL	22.50	(572)	21.06	(535)	20.75	(527)	6.5	(165)	14.3	(362)	25.50	(648)	24.06	(611)	22.37	(568)	29.40	(10)
AL2221-1202	22.50	(572)	21.06	(535)	14.31	(363)	12.1	(306)	2.3	(57)	25.50	(648)	24.06	(611)	15.99	(406)	25.00	(7)
AL2221-1204	22.50	(572)	21.06	(535)	15.81	(402)	12.1	(306)	3.8	(95)	25.50	(648)	24.06	(611)	17.49	(444)	26.20	(8)
AL2221-1205	22.50	(572)	21.06	(535)	17.06	(433)	12.1	(306)	5	(127)	25.50	(648)	24.06	(611)	18.75	(476)	27.30	(9)
AL2221-1214AC	22.50	(572)	21.06	(535)	26.31	(668)	12.1	(306)	14.3	(362)	25.50	(648)	24.06	(611)	27.99	(711)	31.80	(13)
AL2221-1802	22.50	(572)	21.06	(535)	20.87	(530)	18.6	(473)	2.3	(57)	25.50	(648)	24.06	(611)	22.56	(573)	32.00	(10)
AL2221-1804	22.50	(572)	21.06	(535)	22.37	(568)	18.6	(473)	3.8	(95)	25.50	(648)	24.06	(611)	24.06	(611)	33.20	(11)
AL2221-1805	22.50	(572)	21.06	(535)	23.62	(600)	18.6	(473)	5	(127)	25.50	(648)	24.06	(611)	25.31	(643)	34.10	(11)
AL2221-1814AC	22.50	(572)	21.06	(535)	32.87	(835)	18.6	(473)	14.3	(362)	25.50	(648)	24.06	(611)	34.57	(878)	38.60	(16)
AL2221-2302	23.30	(592)	21.40	(544)	25.40	(645)	23.3	(592)	2.1	(53)	26.50	(673)	24.60	(625)	27.50	(699)	28.50	(12)
AL2221-2304	23.30	(592)	21.40	(544)	27.40	(696)	23.3	(592)	4.1	(104)	26.50	(673)	24.60	(625)	29.10	(739)	29.90	(13)
AL2221-2305	23.30	(592)	21.40	(544)	28.70	(729)	23.3	(592)	5.4	(137)	26.50	(673)	24.60	(625)	30.40	(772)	30.80	(14)
AL2221-2314AC	23.30	(592)	21.40	(544)	38.10	(968)	18.6	(473)	14.3	(362)	26.50	(673)	24.60	(625)	39.90	(1013)	36.90	(18)
AL2221-2802	22.50	(572)	21.06	(535)	30.75	(781)	28.1	(714)	2.3	(57)	25.50	(648)	24.06	(611)	32.07	(815)	38.60	(15)
AL2221-2804	22.50	(572)	21.06	(535)	31.87	(809)	28.1	(714)	3.8	(95)	25.50	(648)	24.06	(611)	33.57	(853)	39.80	(15)
AL2221-2805	22.50	(572)	21.06	(535)	33.12	(841)	28.1	(714)	5	(127)	25.50	(648)	24.06	(611)	34.81	(884)	40.60	(16)
AL2221-2814AC	22.50	(572)	21.06	(535)	42.37	(1076)	28.1	(714)	14.3	(362)	25.50	(648)	24.06	(611)	44.07	(1119)	39.10	(20)
AL2313-1004	23.00	(584)	13.00	(330)	15.48	(393)	10.9	(276)	4.6	(118)	26.00	(660)	16.00	(406)	17.67	(449)	20.20	(8)
AL2315-2507	23.25	(591)	15.25	(387)	32.49	(825)	25.4	(644)	7.1	(181)	26.25	(667)	18.25	(464)	35.70	(907)	32.20	(16)
AL2316-0604	23.50	(597)	15.87	(403)	11.24	(285)	6.4	(162)	4.9	(124)	26.50	(673)	18.87	(479)	13.43	(341)	19.80	(6)
AL2318-1205	22.87	(581)	17.93	(455)	17.45	(443)	12.3	(311)	5.2	(132)	25.87	(657)	20.93	(532)	19.39	(493)	25.50	(9)
AL2318-1705	22.87	(581)	17.93	(455)	22.30	(566)	17.2	(436)	5.2	(132)	25.87	(657)	20.93	(532)	24.24	(616)	29.10	(11)
CL2406-0303	24.75	(629)	6.62	(168)	6.12	(155)	3.1	(78)	3.1	(78)	26.87	(682)	8.62	(219)	7.81	(198)	6.60	(4)
CL2407-0404	24.75	(629)	7.50	(191)	6.86	(174)	3.5	(89)	3.4	(85)	26.87	(682)	9.50	(241)	8.55	(217)	8.80	(4)
AL2412-1505	24.18	(614)	12.00	(305)	20.08	(510)	14.9	(378)	5.2	(132)	27.18	(690)	15.00	(381)	22.27	(566)	22.00	(10)
AL2414-0509AC/HL	24.62	(625)	14.57	(370)	14.52	(369)	5.2	(132)	9.3	(237)	27.62	(702)	17.57	(446)	16.71	(424)	23.60	(8)

Weights shown is the empty container weight, with handles and hardware in the standard configuration.
Outside dims do not include a box.

SINGLE LID SIZE LIST

OCT 2017 | Rev. 1

CASE SIZE	INSIDE DIMENSIONS						EXTERIOR DIMENSIONS											
	L		W		H		BASE		LID		L		W		H		WEIGHT	
	in	(mm)	in	(mm)	in	(mm)	in	(mm)	in	(mm)	in	(mm)	in	(mm)	in	(mm)	lbs	(kg)
AL2414-1604	24.25	(616)	14.25	(362)	20.12	(511)	16.1	(408)	4.1	(103)	27.25	(692)	17.25	(438)	22.12	(562)	23.00	(10)
AL2415-0215AC/HL	24.25	(616)	15.25	(387)	16.77	(426)	1.9	(49)	14.8	(377)	27.25	(692)	18.25	(464)	18.96	(482)	25.70	(9)
AL2417-1505	24.00	(610)	17.00	(432)	20.02	(509)	14.8	(377)	5.2	(132)	27.00	(686)	20.00	(508)	21.96	(558)	27.30	(10)
AL2423-0503	24.75	(629)	23.25	(591)	7.99	(203)	4.7	(119)	3.3	(84)	27.75	(705)	26.25	(667)	11.56	(294)	23.30	(5)
AL2423-0504	24.75	(629)	23.25	(591)	8.58	(218)	4.7	(119)	3.9	(99)	27.75	(705)	26.25	(667)	12.15	(309)	24.00	(6)
AL2423-0506	24.75	(629)	23.25	(591)	10.93	(278)	4.7	(119)	6.3	(159)	27.75	(705)	26.25	(667)	13.04	(331)	25.00	(6)
AL2423-0511AC/HL	24.75	(629)	23.25	(591)	15.93	(405)	4.7	(119)	11.3	(286)	27.75	(705)	26.25	(667)	19.55	(497)	30.20	(9)
AL2423-0903	24.75	(629)	23.25	(591)	12.06	(306)	8.8	(222)	3.3	(84)	27.75	(705)	26.25	(667)	15.20	(386)	24.90	(7)
AL2423-0904	24.75	(629)	23.25	(591)	12.65	(321)	8.8	(222)	3.9	(99)	27.75	(705)	26.25	(667)	15.79	(401)	25.60	(7)
AL2423-0906	24.75	(629)	23.25	(591)	15.00	(381)	8.8	(222)	6.3	(159)	27.75	(705)	26.25	(667)	18.19	(462)	28.00	(8)
AL2423-0911AC/HL	24.75	(629)	23.25	(591)	20.00	(508)	8.8	(222)	11.3	(286)	27.75	(705)	26.25	(667)	23.19	(589)	31.80	(11)
AL2423-1103	24.75	(629)	23.25	(591)	14.06	(357)	10.8	(273)	3.3	(84)	27.75	(705)	26.25	(667)	16.75	(425)	27.30	(8)
AL2423-1104	24.75	(629)	23.25	(591)	14.65	(372)	10.8	(273)	3.9	(99)	27.75	(705)	26.25	(667)	17.34	(440)	28.00	(8)
AL2423-1106	24.75	(629)	23.25	(591)	17.00	(432)	10.8	(273)	6.3	(159)	27.75	(705)	26.25	(667)	19.69	(500)	29.50	(9)
AL2423-1111AC/HL	24.75	(629)	23.25	(591)	22.00	(559)	10.8	(273)	11.3	(286)	27.75	(705)	26.25	(667)	24.69	(627)	32.30	(11)
AL2617-0604	26.00	(660)	17.25	(438)	9.89	(251)	6.1	(156)	3.8	(95)	29.00	(737)	20.25	(514)	12.08	(307)	22.50	(5)
AL2617-1104	26.00	(660)	17.25	(438)	14.75	(375)	11	(279)	3.8	(95)	29.00	(737)	20.25	(514)	16.94	(430)	26.20	(8)
AL2624-0503	26.00	(660)	24.00	(610)	8.75	(222)	5.4	(136)	3.4	(86)	29.00	(737)	27.00	(686)	12.00	(305)	24.00	(5)
AL2624-0505	26.00	(660)	24.00	(610)	10.43	(265)	5.4	(136)	5.1	(129)	29.00	(737)	27.00	(686)	13.89	(353)	28.00	(6)
AL2624-0513	26.00	(660)	24.00	(610)	18.49	(470)	5.4	(136)	13.1	(333)	29.00	(737)	27.00	(686)	21.94	(557)	32.00	(10)
AL2624-0524	26.00	(660)	24.00	(610)	29.39	(747)	5.4	(136)	24	(610)	29.00	(737)	27.00	(686)	32.66	(830)	42.00	(15)
AL2624-0803	26.00	(660)	24.00	(610)	11.43	(290)	8.1	(205)	3.4	(86)	29.00	(737)	27.00	(686)	14.50	(368)	28.00	(7)
AL2624-0805	26.06	(662)	24.00	(610)	13.12	(333)	8.1	(205)	5.1	(129)	29.06	(738)	27.00	(686)	16.81	(427)	31.30	(8)
AL2624-0813AC/HL	26.06	(662)	24.00	(610)	21.18	(538)	8.1	(205)	13.1	(333)	29.06	(738)	27.00	(686)	24.87	(632)	36.20	(11)
AL2624-0824AC/HL	26.06	(662)	24.00	(610)	32.06	(814)	8.1	(205)	24	(610)	29.06	(738)	27.00	(686)	35.75	(908)	45.40	(16)
AL2624-1203	26.00	(660)	24.00	(610)	15.24	(387)	11.9	(301)	3.4	(86)	29.00	(737)	27.00	(686)	18.46	(469)	31.00	(8)
AL2624-1205	26.06	(662)	24.00	(610)	16.93	(430)	11.9	(301)	5.1	(129)	29.06	(738)	27.00	(686)	20.69	(526)	34.10	(9)
AL2624-1213AC/HL	26.06	(662)	24.00	(610)	24.99	(635)	11.9	(301)	13.1	(333)	29.06	(738)	27.00	(686)	28.69	(729)	38.20	(13)
AL2624-1224AC/HL	26.06	(662)	24.00	(610)	35.87	(911)	11.9	(301)	24	(610)	29.06	(738)	27.00	(686)	39.57	(1005)	48.20	(18)
AL2624-1803	26.00	(660)	24.00	(610)	21.18	(538)	17.8	(452)	3.4	(86)	29.00	(737)	27.00	(686)	25.12	(638)	35.00	(11)
AL2624-1805	26.06	(662)	24.00	(610)	22.87	(581)	17.8	(452)	5.1	(129)	29.06	(738)	27.00	(686)	26.62	(676)	38.50	(12)

Weights shown is the empty container weight, with handles and hardware in the standard configuration.
Outside dims do not include a box.

SINGLE LID SIZE LIST

OCT 2017 | Rev. 1

CASE SIZE	INSIDE DIMENSIONS						EXTERIOR DIMENSIONS											
	L		W		H		BASE		LID		L		W		H		WEIGHT	
	in	(mm)	in	(mm)	in	(mm)	in	(mm)	in	(mm)	in	(mm)	in	(mm)	in	(mm)	lbs	(kg)
AL2624-1813AC/HL	26.06	(662)	24.00	(610)	30.93	(786)	17.8	(452)	13.1	(333)	29.06	(738)	27.00	(686)	34.62	(879)	43.50	(16)
AL2624-1824AC	26.06	(662)	24.00	(610)	41.81	(1062)	17.8	(452)	24	(610)	29.06	(738)	27.00	(686)	45.50	(1156)	52.40	(21)
AL2624-2703	26.00	(660)	24.00	(610)	30.04	(763)	26.7	(677)	3.4	(86)	29.00	(737)	27.00	(686)	34.37	(873)	41.00	(16)
AL2624-2705	26.06	(662)	24.00	(610)	31.73	(806)	26.7	(677)	5.1	(129)	29.06	(738)	27.00	(686)	35.48	(901)	44.50	(16)
AL2624-2713	26.06	(662)	24.00	(610)	39.79	(1011)	26.7	(677)	13.1	(333)	29.06	(738)	27.00	(686)	43.48	(1104)	49.40	(20)
AL2624-2724AC	26.06	(662)	24.00	(610)	50.67	(1287)	26.7	(677)	24	(610)	29.06	(738)	27.00	(686)	54.73	(1390)	58.30	(25)
AL2727-0404	27.00	(686)	27.00	(686)	7.49	(190)	3.6	(92)	3.9	(98)	30.00	(762)	30.00	(762)	9.69	(246)	30.50	(4)
AL2727-0405	27.00	(686)	27.00	(686)	8.62	(219)	3.6	(92)	5	(127)	30.00	(762)	30.00	(762)	10.81	(275)	32.00	(5)
AL2727-0409AC/HL	27.00	(686)	27.00	(686)	12.87	(327)	3.6	(92)	9.3	(235)	30.00	(762)	30.00	(762)	15.06	(383)	34.50	(7)
AL2727-0414AC/HL	27.00	(686)	27.00	(686)	17.87	(454)	3.6	(92)	14.3	(362)	30.00	(762)	30.00	(762)	20.06	(510)	38.50	(9)
AL2727-0504	27.00	(686)	27.00	(686)	8.87	(225)	5	(127)	3.9	(98)	30.00	(762)	30.00	(762)	11.06	(281)	30.60	(5)
AL2727-0505	27.00	(686)	27.00	(686)	10.00	(254)	5	(127)	5	(127)	30.00	(762)	30.00	(762)	12.19	(310)	32.00	(6)
AL2727-0509AC/HL	27.00	(686)	27.00	(686)	14.25	(362)	5	(127)	9.3	(235)	30.00	(762)	30.00	(762)	16.44	(418)	34.60	(7)
AL2727-0514AC/HL	27.00	(686)	27.00	(686)	19.25	(489)	5	(127)	14.3	(362)	30.00	(762)	30.00	(762)	21.44	(545)	38.70	(10)
AL2727-0904	27.00	(686)	27.00	(686)	12.67	(322)	8.8	(224)	3.9	(98)	30.00	(762)	30.00	(762)	14.86	(377)	33.00	(7)
AL2727-0905	27.00	(686)	27.00	(686)	13.80	(351)	8.8	(224)	5	(127)	30.00	(762)	30.00	(762)	15.99	(406)	34.50	(7)
AL2727-0909AC/HL	27.00	(686)	27.00	(686)	18.05	(458)	8.8	(224)	9.3	(235)	30.00	(762)	30.00	(762)	20.24	(514)	37.00	(9)
AL2727-0914AC/HL	27.00	(686)	27.00	(686)	23.05	(585)	8.8	(224)	14.3	(362)	30.00	(762)	30.00	(762)	25.24	(641)	41.10	(11)
AL2727-1404	27.00	(686)	27.00	(686)	17.99	(457)	14.1	(359)	3.9	(98)	30.00	(762)	30.00	(762)	20.18	(513)	37.10	(9)
AL2727-1405	27.00	(686)	27.00	(686)	19.12	(486)	14.1	(359)	5	(127)	30.00	(762)	30.00	(762)	21.31	(541)	38.60	(10)
AL2727-1409AC	27.00	(686)	27.00	(686)	23.37	(594)	14.1	(359)	9.3	(235)	30.00	(762)	30.00	(762)	25.56	(649)	41.10	(12)
AL2727-1414AC/HL	27.00	(686)	27.00	(686)	28.37	(721)	14.1	(359)	14.3	(362)	30.00	(762)	30.00	(762)	30.56	(776)	45.20	(14)
AL2727-2304	27.00	(686)	27.00	(686)	26.62	(676)	22.8	(578)	3.9	(98)	30.00	(762)	30.00	(762)	28.79	(731)	43.20	(13)
AL2727-2305	27.00	(686)	27.00	(686)	27.75	(705)	22.8	(578)	5	(127)	30.00	(762)	30.00	(762)	29.94	(760)	43.30	(14)
AL2727-2309AC	27.00	(686)	27.00	(686)	36.22	(920)	22.8	(578)	9.3	(235)	30.00	(762)	30.00	(762)	38.41	(976)	51.60	(17)
AL2727-2709AC	27.00	(686)	27.00	(686)	32.40	(823)	9.5	(241)	22.9	(582)	30.10	(765)	30.10	(765)	34.60	(879)	42.20	(16)
AL2727-2314AC	27.00	(686)	27.00	(686)	37.00	(940)	22.8	(578)	14.3	(362)	30.00	(762)	30.00	(762)	39.19	(995)	53.00	(18)
AL2727-2704	27.00	(686)	27.00	(686)	30.84	(783)	27	(685)	3.9	(98)	30.00	(762)	30.00	(762)	33.03	(839)	47.60	(15)
AL2727-2705	27.00	(686)	27.00	(686)	31.97	(812)	27	(685)	5	(127)	30.00	(762)	30.00	(762)	34.19	(868)	49.00	(16)
AL2727-2714AC	27.00	(686)	27.00	(686)	41.22	(1047)	27	(685)	14.3	(362)	30.00	(762)	30.00	(762)	43.41	(1103)	55.50	(20)
AL2818-0805	28.12	(714)	18.12	(460)	13.24	(336)	8.1	(206)	5.1	(130)	31.12	(790)	21.12	(536)	15.43	(392)	26.50	(7)

Weights shown is the empty container weight, with handles and hardware in the standard configuration.
Outside dims do not include a box.

SINGLE LID SIZE LIST

OCT 2017 | Rev. 1

CASE SIZE	INSIDE DIMENSIONS						EXTERIOR DIMENSIONS											
	L		W		H		BASE		LID		L		W		H		WEIGHT	
	in	(mm)	in	(mm)	in	(mm)	in	(mm)	in	(mm)	in	(mm)	in	(mm)	in	(mm)	lbs	(kg)
AL2822-1212AC	28.13	(715)	24.25	(616)	22.13	(562)	12.12	(308)	12.13	(308)	31.25	(794)	25.25	(641)	26.75	(679)	38.50	(12)
AL2825-1205	28.50	(724)	25.00	(635)	17.74	(451)	12.6	(321)	5.1	(130)	31.50	(800)	28.00	(711)	19.43	(494)	37.40	(9)
AL2825-1212AC/HL	28.50	(724)	25.00	(635)	24.92	(633)	12.6	(321)	12.3	(312)	31.50	(800)	28.00	(711)	26.43	(671)	44.00	(12)
AL2825-1605	28.50	(724)	25.00	(635)	21.62	(549)	16.5	(419)	5.1	(130)	31.50	(800)	28.00	(711)	23.86	(606)	39.00	(11)
AL2825-1612AC/HL	28.50	(724)	25.00	(635)	28.80	(732)	16.5	(419)	12.3	(312)	31.50	(800)	28.00	(711)	30.99	(787)	45.60	(14)
AL2909-0605	28.50	(724)	8.50	(216)	11.25	(286)	6	(152)	5.3	(133)	31.50	(800)	11.50	(292)	12.94	(329)	15.90	(6)
AL2914-0605	29.60	(752)	14.80	(376)	10.30	(262)	5.4	(137)	5.9	(150)	32.80	(833)	18.00	(457)	11.60	(295)	20.60	(5)
AL2914-0606	29.60	(752)	14.80	(376)	11.60	(295)	5.4	(137)	6.7	(170)	32.80	(833)	18.00	(457)	13.20	(335)	21.50	(6)
AL2914-0618	29.60	(752)	14.80	(376)	25.70	(653)	5.4	(137)	19.8	(503)	32.80	(833)	18.00	(457)	27.30	(693)	29.50	(12)
AL2914-0905	28.87	(733)	14.50	(368)	14.05	(357)	8.9	(225)	5.2	(132)	31.87	(809)	17.50	(445)	16.00	(406)	23.10	(7)
AL2914-0906	28.87	(733)	14.50	(368)	15.05	(382)	8.9	(225)	6.2	(157)	31.87	(809)	17.50	(445)	17.00	(432)	24.50	(8)
AL2914-0918	29.60	(752)	14.80	(376)	29.00	(737)	9.2	(234)	19.8	(534)	32.80	(833)	18.00	(457)	30.50	(775)	42.50	(14)
AL2924-0904	29.24	(743)	23.87	(606)	13.31	(338)	9.3	(237)	4	(101)	32.24	(819)	26.87	(682)	15.50	(394)	30.30	(7)
AL3018-0402	29.75	(756)	17.87	(454)	7.12	(181)	4.5	(114)	2.6	(67)	32.75	(832)	20.87	(530)	8.94	(227)	20.40	(4)
AL3018-0403	29.75	(756)	17.87	(454)	8.12	(206)	4.5	(114)	3.6	(92)	32.75	(832)	20.87	(530)	9.94	(252)	21.20	(5)
AL3018-0405	29.75	(756)	17.87	(454)	9.75	(248)	4.5	(114)	5.3	(133)	32.75	(832)	20.87	(530)	11.56	(294)	21.50	(5)
AL3018-0409	29.75	(756)	17.87	(454)	13.75	(349)	4.5	(114)	9.3	(235)	32.75	(832)	20.87	(530)	15.56	(395)	27.70	(7)
AL3018-0802	29.75	(756)	17.87	(454)	10.80	(274)	8.2	(208)	2.6	(67)	32.75	(832)	20.87	(530)	12.61	(320)	24.90	(6)
AL3018-0803	29.75	(756)	17.87	(454)	11.80	(300)	8.2	(208)	3.6	(92)	32.75	(832)	20.87	(530)	13.61	(346)	25.70	(6)
AL3018-0805	29.75	(756)	17.87	(454)	13.43	(341)	8.2	(208)	5.3	(133)	32.75	(832)	20.87	(530)	15.24	(387)	26.00	(7)
AL3018-0809AC/HL	29.75	(756)	17.87	(454)	17.43	(443)	8.2	(208)	9.3	(235)	32.75	(832)	20.87	(530)	19.24	(489)	32.20	(9)
AL3018-0902	29.75	(756)	17.87	(454)	11.99	(305)	9.4	(238)	2.6	(67)	32.75	(832)	20.87	(530)	13.81	(351)	26.80	(6)
AL3018-0903	29.75	(756)	17.87	(454)	12.99	(330)	9.4	(238)	3.6	(92)	32.75	(832)	20.87	(530)	14.81	(376)	27.60	(7)
AL3018-0905	29.75	(756)	17.87	(454)	14.62	(371)	9.4	(238)	5.3	(133)	32.75	(832)	20.87	(530)	16.43	(417)	27.80	(7)
AL3018-0909AC/HL	29.75	(756)	17.87	(454)	18.62	(473)	9.4	(238)	9.3	(235)	32.75	(832)	20.87	(530)	20.43	(519)	33.90	(9)
AL3018-1502	29.75	(756)	17.87	(454)	17.49	(444)	14.9	(378)	2.6	(67)	32.75	(832)	20.87	(530)	19.31	(490)	29.70	(9)
AL3018-1503	29.75	(756)	17.87	(454)	18.49	(470)	14.9	(378)	3.6	(92)	32.75	(832)	20.87	(530)	20.31	(516)	30.50	(9)
AL3018-1505	29.75	(756)	17.87	(454)	20.12	(511)	14.9	(378)	5.3	(133)	32.75	(832)	20.87	(530)	21.93	(557)	31.80	(10)
AL3018-1509AC	29.75	(756)	17.87	(454)	24.12	(613)	14.9	(378)	9.3	(235)	32.75	(832)	20.87	(530)	25.93	(659)	37.00	(12)
AL3018-2302	29.75	(756)	17.88	(454)	26.38	(670)	23.8	(603)	2.6	(67)	32.75	(832)	20.88	(530)	28.19	(716)	38.00	(13)
AL3018-2303	29.75	(756)	17.88	(454)	27.38	(695)	23.8	(603)	3.6	(92)	32.75	(832)	20.88	(530)	29.19	(741)	40.50	(13)

Weights shown is the empty container weight, with handles and hardware in the standard configuration.

Outside dims do not include a box.

SINGLE LID SIZE LIST

OCT 2017 | Rev. 1

CASE SIZE	INSIDE DIMENSIONS						EXTERIOR DIMENSIONS											
	L		W		H		BASE		LID		L		W		H		WEIGHT	
	in	(mm)	in	(mm)	in	(mm)	in	(mm)	in	(mm)	in	(mm)	in	(mm)	in	(mm)	lbs	(kg)
AL3018-2305	29.75	(756)	17.88	(454)	29.00	(737)	23.8	(603)	5.3	(133)	32.75	(832)	20.88	(530)	30.81	(783)	40.50	(14)
AL3018-2309	29.75	(756)	17.88	(454)	33.00	(838)	23.8	(603)	9.3	(235)	32.75	(832)	20.88	(530)	34.81	(884)	43.00	(16)
AL3018-3602	29.75	(756)	17.87	(454)	38.87	(987)	36.3	(921)	2.6	(67)	32.75	(832)	20.87	(530)	40.68	(1033)	43.00	(18)
AL3018-3603	29.75	(756)	17.87	(454)	39.87	(1013)	36.3	(921)	3.6	(92)	32.75	(832)	20.87	(530)	41.68	(1059)	43.80	(19)
AL3018-3605	29.75	(756)	17.87	(454)	41.50	(1054)	36.3	(921)	5.3	(133)	32.75	(832)	20.87	(530)	43.31	(1100)	44.30	(20)
AL3018-3609AC	29.75	(756)	17.87	(454)	45.50	(1156)	36.3	(921)	9.3	(235)	32.75	(832)	20.87	(530)	47.31	(1202)	50.30	(21)
AL3019-0709AC/HL	30.75	(781)	19.62	(498)	16.98	(431)	7.6	(194)	9.3	(237)	33.75	(857)	22.62	(575)	19.67	(500)	40.60	(9)
AL3022-0705	30.00	(762)	22.18	(563)	12.18	(309)	7	(178)	5.2	(132)	33.00	(838)	25.18	(640)	13.97	(355)	36.80	(6)
AL3124-1204	31.43	(798)	24.40	(620)	15.68	(398)	11.9	(301)	3.8	(97)	34.43	(875)	27.40	(696)	19.37	(492)	30.00	(9)
AL3124-1604	31.43	(798)	24.40	(620)	19.68	(500)	15.9	(403)	3.8	(97)	34.43	(875)	27.40	(696)	23.37	(594)	39.60	(11)
AL3226-1404FT	32.50	(826)	26.62	(676)	18.36	(466)	14.2	(360)	4.2	(106)	35.50	(902)	29.62	(752)	24.31	(617)	52.40	(11)
AL3226-1413	32.50	(826)	26.62	(676)	27.08	(688)	14.2	(360)	12.9	(328)	35.50	(902)	29.62	(752)	32.93	(836)	60.90	(15)
AL3226-1604	32.50	(826)	26.62	(676)	20.30	(516)	16.1	(409)	4.2	(106)	35.50	(902)	29.62	(752)	24.49	(622)	52.60	(11)
AL3226-1613AC/HL	32.50	(826)	26.62	(676)	29.02	(737)	16.1	(409)	12.9	(328)	35.50	(902)	29.62	(752)	33.21	(844)	62.50	(15)
AL3232-1111	32.40	(823)	32.40	(823)	23.50	(597)	12	(305)	11.5	(292)	35.50	(902)	35.50	(902)	26.50	(673)	65.90	(12)
AL3232-1412AC	32.43	(824)	32.43	(824)	26.75	(679)	14.7	(373)	12.4	(315)	35.43	(900)	35.43	(900)	30.44	(773)	68.40	(14)
AL3418-0505	34.18	(868)	17.87	(454)	10.50	(267)	5.3	(133)	5.3	(133)	37.18	(944)	20.87	(530)	12.44	(316)	27.00	(6)
AL3418-1005	34.18	(868)	17.87	(454)	15.37	(390)	10.1	(257)	5.3	(133)	37.18	(944)	20.87	(530)	17.31	(440)	30.60	(8)
AL3424-0804	34.25	(870)	24.18	(614)	12.30	(312)	8	(203)	4.3	(109)	37.25	(946)	27.18	(690)	14.49	(368)	34.30	(7)
AL3424-0805	34.25	(870)	24.18	(614)	13.25	(337)	8	(203)	5.3	(133)	37.25	(946)	27.18	(690)	15.44	(392)	36.80	(7)
AL3424-1204	34.25	(870)	24.18	(614)	16.30	(414)	12	(305)	4.3	(109)	37.25	(946)	27.18	(690)	18.49	(470)	40.00	(8)
AL3424-1205	34.25	(870)	24.18	(614)	17.25	(438)	12	(305)	5.3	(133)	37.25	(946)	27.18	(690)	19.44	(494)	42.50	(9)
AL3428-0604	34.00	(864)	27.50	(699)	9.88	(251)	6.1	(155)	3.8	(95)	37.00	(940)	30.50	(775)	12.19	(310)	38.90	(6)
AL3428-0608AC/HL	34.00	(864)	27.50	(699)	14.31	(363)	6.1	(155)	8.2	(208)	37.00	(940)	30.50	(775)	16.62	(422)	42.50	(8)
AL3428-0614AC/HL	34.00	(864)	27.50	(699)	20.37	(517)	6.1	(155)	14.4	(364)	37.00	(940)	30.50	(775)	22.68	(576)	47.50	(10)
AL3428-0625AC/HL	34.00	(864)	27.50	(699)	30.92	(785)	6.1	(155)	24.8	(630)	37.00	(940)	30.50	(775)	33.23	(844)	57.00	(15)
AL3428-1004	34.00	(864)	27.50	(699)	13.56	(344)	9.8	(249)	3.8	(95)	37.00	(940)	30.50	(775)	15.75	(400)	48.60	(7)
AL3428-1008AC	34.00	(864)	27.50	(699)	18.00	(457)	9.8	(249)	8.2	(208)	37.00	(940)	30.50	(775)	20.19	(513)	50.60	(9)
AL3428-1014AC/HL	34.00	(864)	27.50	(699)	24.16	(614)	9.8	(249)	14.4	(364)	37.00	(940)	30.50	(775)	26.35	(669)	61.50	(12)
AL3428-1025AC/HL	34.00	(864)	27.50	(699)	34.61	(879)	9.8	(249)	24.8	(630)	37.00	(940)	30.50	(775)	36.74	(933)	64.10	(17)
AL3434-1207	34.38	(873)	34.38	(873)	19.75	(502)	12.5	(318)	7.3	(184)	37.38	(949)	37.38	(949)	22.43	(570)	55.20	(10)

Weights shown is the empty container weight, with handles and hardware in the standard configuration.
Outside dims do not include a box.

SINGLE LID SIZE LIST

OCT 2017 | Rev. 1

CASE SIZE	INSIDE DIMENSIONS						EXTERIOR DIMENSIONS											
	L		W		H		BASE		LID		L		W		H		WEIGHT	
	in	(mm)	in	(mm)	in	(mm)	in	(mm)	in	(mm)	in	(mm)	in	(mm)	in	(mm)	lbs	(kg)
AL3434-1228AC	34.38	(873)	34.38	(873)	41.00	(1041)	12.5	(318)	28.5	(724)	37.38	(949)	37.38	(949)	44.50	(1130)	87.00	(20)
AL3434-2807	34.38	(873)	34.38	(873)	34.93	(887)	27.7	(703)	7.3	(184)	37.38	(949)	37.38	(949)	38.43	(976)	66.80	(17)
AL3434-2828AC	34.38	(873)	34.38	(873)	56.24	(1428)	27.7	(703)	28.5	(724)	37.38	(949)	37.38	(949)	59.43	(1510)	72.10	(27)
AL3535-1605	35.50	(902)	35.50	(902)	20.87	(530)	15.8	(400)	5.1	(130)	38.50	(978)	38.50	(978)	24.19	(614)	68.00	(11)
AL3620-0504	35.87	(911)	19.87	(505)	9.00	(229)	5	(127)	4	(102)	38.87	(987)	22.87	(581)	10.80	(274)	23.40	(5)
AL3620-0505	35.87	(911)	19.87	(505)	10.12	(257)	5	(127)	5.1	(130)	38.87	(987)	22.87	(581)	12.30	(312)	25.60	(6)
AL3620-0510AC/HL	35.87	(911)	19.87	(505)	15.15	(385)	5	(127)	9.9	(251)	38.87	(987)	22.87	(581)	17.00	(432)	32.40	(8)
AL3620-0512	35.80	(909)	19.80	(503)	17.20	(437)	4.8	(122)	12.1	(307)	38.80	(986)	22.80	(579)	19.00	(483)	38.90	(9)
AL3620-1704	35.87	(911)	19.87	(505)	21.12	(536)	17.1	(435)	4	(102)	38.87	(987)	22.87	(581)	23.31	(592)	41.60	(11)
AL3620-1705	35.87	(911)	19.87	(505)	22.24	(565)	17.1	(435)	5.1	(130)	38.87	(987)	22.87	(581)	24.43	(621)	43.30	(11)
AL3620-1710	35.87	(911)	19.87	(505)	27.27	(693)	17.1	(435)	9.9	(252)	38.87	(987)	22.87	(581)	29.46	(748)	50.40	(13)
AL3620-1712	35.90	(912)	19.90	(505)	29.30	(744)	17	(432)	10.7	(272)	38.90	(988)	22.90	(582)	31.50	(800)	47.70	(14)
AL3627-0805	35.87	(911)	27.00	(686)	12.95	(329)	7.8	(199)	5.1	(130)	38.87	(987)	30.00	(762)	16.64	(423)	43.60	(8)
AL3627-1505	35.87	(911)	27.00	(686)	19.99	(508)	14.9	(378)	5.1	(130)	38.87	(987)	30.00	(762)	23.69	(602)	50.30	(11)
AL3633-0405AC/HL	36.31	(922)	33.31	(846)	10.15	(258)	4.5	(114)	5.7	(144)	39.31	(998)	36.31	(922)	11.84	(301)	43.00	(5)
AL3825-2704	37.63	(956)	24.63	(626)	30.44	(773)	26.44	(672)	4	(10.2)	40.75	(1035)	27.75	(705)	32.94	(837)	54.00	(15)
AL3834-1605	38.12	(968)	34.12	(867)	21.15	(537)	15.8	(400)	5.4	(137)	41.12	(1044)	37.12	(943)	26.97	(685)	71.00	(12)
AL3834-1617FT/AC/HL	38.12	(968)	34.12	(867)	33.00	(838)	15.8	(400)	17.3	(438)	41.12	(1044)	37.12	(943)	38.82	(986)	86.40	(18)
AL3834-1628FT/AC	38.12	(968)	34.12	(867)	44.06	(1119)	15.8	(400)	28.3	(719)	41.12	(1044)	37.12	(943)	49.88	(1267)	118.00	(23)
AL4018-1003	40.00	(1016)	18.00	(457)	13.19	(335)	10.2	(259)	3	(76)	43.00	(1092)	21.00	(533)	14.75	(375)	36.00	(7)
AL4021-0804	41.00	(1041)	20.87	(530)	11.00	(279)	7.2	(183)	3.8	(97)	44.00	(1118)	23.87	(606)	13.69	(348)	37.00	(6)
AL4021-0808AC/HL	41.00	(1041)	20.87	(530)	14.91	(379)	7.2	(183)	7.7	(196)	44.00	(1118)	23.87	(606)	17.60	(447)	41.00	(8)
AL4024-1305	39.87	(1013)	24.31	(617)	18.00	(457)	12.8	(324)	5.3	(133)	42.87	(1089)	27.31	(694)	20.19	(513)	50.20	(9)
AL4028-1608	39.75	(1010)	27.75	(705)	23.65	(601)	15.5	(393)	8.2	(208)	42.75	(1086)	30.75	(781)	27.34	(694)	70.00	(12)
AL4028-2105	39.75	(1010)	27.75	(705)	25.55	(649)	20.4	(517)	5.2	(132)	42.75	(1086)	30.75	(781)	29.24	(743)	80.00	(13)
AL4119-0704	40.58	(1031)	19.10	(485)	11.60	(295)	8.1	(204)	4.5	(114)	43.70	(1110)	22.10	(561)	12.80	(325)	32.00	(6)
AL4141-0808	41.00	(1041)	41.00	(1041)	16.38	(416)	8.3	(211)	8.1	(206)	44.00	(1118)	44.00	(1118)	18.00	(457)	84.10	(8)
AL4141-0826AC	41.00	(1041)	41.00	(1041)	34.00	(864)	8.3	(210)	25.8	(654)	44.00	(1118)	44.00	(1118)	35.50	(902)	114.00	(16)
AL4141-0836AC	41.00	(1041)	41.00	(1041)	43.75	(1111)	8.3	(210)	35.5	(902)	44.00	(1118)	44.00	(1118)	45.50	(1156)	123.00	(21)
AL4141-0846AC	41.00	(1041)	41.00	(1041)	53.75	(1365)	8.3	(210)	45.5	(1156)	44.00	(1118)	44.00	(1118)	55.50	(1410)	132.00	(25)
AL4416-1026	44.41	(1128)	16.26	(413)	36.91	(938)	10.38	(264)	26.53	(674)	47.50	(1207)	19.35	(491)	38.47	(977)	69.50	(17)

Weights shown is the empty container weight, with handles and hardware in the standard configuration.

Outside dims do not include a box.

SINGLE LID SIZE LIST

OCT 2017 | Rev. 1

CASE SIZE	INSIDE DIMENSIONS						EXTERIOR DIMENSIONS											
	L		W		H		BASE		LID		L		W		H		WEIGHT	
	in	(mm)	in	(mm)	in	(mm)	in	(mm)	in	(mm)	in	(mm)	in	(mm)	in	(mm)	lbs	(kg)
AL4421-0813	44.13	(1121)	21.13	(537)	21.25	(540)	8.13	(207)	13.12	(333)	47.25	(1200)	24.25	(616)	23.75	(603)	53.46	(11)
AL4532-0506	45.00	(1143)	32.00	(813)	11.25	(286)	5.2	(132)	6	(152)	48.00	(1219)	35.00	(889)	14.50	(368)	63.20	(7)
AL4532-0515FT/AC/HL	45.00	(1143)	32.00	(813)	20.12	(511)	5.3	(133)	14.9	(378)	48.00	(1219)	35.00	(889)	25.00	(635)	81.20	(11)
AL4532-1606	45.00	(1143)	32.00	(813)	21.50	(546)	15.5	(394)	6	(152)	48.00	(1219)	35.00	(889)	26.00	(660)	82.00	(12)
AL4532-1615AC/HL	45.00	(1143)	32.00	(813)	30.37	(771)	15.5	(394)	14.9	(378)	48.00	(1219)	35.00	(889)	35.06	(891)	97.20	(16)
AL4714-0403	46.87	(1190)	14.06	(357)	7.00	(178)	4	(102)	3	(76)	49.87	(1267)	17.06	(433)	8.69	(221)	26.40	(4)
AL4714-0405	46.87	(1190)	14.06	(357)	9.25	(235)	4	(102)	5.3	(133)	49.87	(1267)	17.06	(433)	10.94	(278)	27.10	(5)
AL4714-0503	46.87	(1190)	14.06	(357)	8.25	(210)	5.3	(133)	3	(76)	49.87	(1267)	17.06	(433)	9.94	(252)	27.50	(5)
AL4714-0505	46.87	(1190)	14.06	(357)	10.50	(267)	5.3	(133)	5.3	(133)	49.87	(1267)	17.06	(433)	12.19	(310)	29.50	(6)
AL4824-1404	48.62	(1235)	24.62	(625)	17.67	(449)	13.8	(351)	3.9	(98)	51.62	(1311)	27.62	(702)	21.36	(543)	57.90	(10)
DL4824-1404AC	48.62	(1235)	24.62	(625)	17.67	(449)	13.9	(352)	3.9	(98)	51.62	(1311)	27.62	(702)	21.36	(543)	57.90	(10)
AL4824-1408AC	48.62	(1235)	24.62	(625)	21.92	(557)	13.8	(351)	8.1	(206)	51.62	(1311)	27.62	(702)	25.61	(650)	64.50	(12)
DL4824-1408AC	48.00	(1219)	24.00	(610)	22.00	(559)	13.9	(352)	8.1	(206)	51.50	(1308)	27.50	(699)	25.70	(653)	64.50	(12)
AL4824-1604	48.62	(1235)	24.62	(625)	19.67	(500)	15.8	(401)	3.9	(98)	51.62	(1311)	27.62	(702)	23.36	(593)	57.30	(11)
AL4824-1608	48.62	(1235)	24.62	(625)	23.92	(608)	15.8	(401)	8.1	(206)	51.62	(1311)	27.62	(702)	27.61	(701)	63.80	(13)
AL4915-1105	49.00	(1245)	14.81	(376)	16.25	(413)	11	(279)	5.3	(133)	52.00	(1321)	17.81	(452)	18.44	(468)	40.00	(8)
AL5023-0911	50.50	(1283)	23.30	(592)	20.10	(511)	9.1	(231)	11.1	(282)	53.50	(1359)	26.30	(668)	23.50	(597)	50.90	(11)
AL5040-1204	50.12	(1273)	40.00	(1016)	15.87	(403)	12.1	(308)	3.8	(95)	53.12	(1349)	43.00	(1092)	19.06	(484)	90.00	(9)
AL5040-1212AC	50.12	(1273)	40.00	(1016)	23.99	(609)	12.1	(308)	11.9	(301)	53.12	(1349)	43.00	(1092)	27.19	(691)	103.00	(12)
AL5135-0718FT	51.01	(1296)	35.04	(890)	25.22	(641)	6.8	(173)	18.4	(468)	54.01	(1372)	38.04	(966)	32.00	(813)	103.50	(15)
AL5231-0807AC	52.38	(1330)	30.88	(784)	14.50	(368)	7.5	(178)	7	(178)	55.50	(1410)	34.00	(864)	17.00	(432)	56.70	(8)
AL5231-1407AC	52.38	(1330)	30.88	(784)	21.00	(533)	14	(356)	7	(178)	55.00	(1397)	34.00	(864)	23.50	(597)	64.60	(11)
AL5240-1138AC/HL	52.00	(1321)	40.00	(1016)	49.00	(1245)	11	(279)	38	(965)	55.00	(1397)	43.00	(1092)	52.69	(1338)	143.10	(24)
AL5415-0504W	53.90	(1369)	15.40	(391)	9.50	(241)	5.3	(135)	4.2	(107)	56.90	(1445)	18.50	(470)	11.30	(287)	31.50	(5)
AL5415-1026AC	54.00	(1372)	15.88	(403)	36.38	(924)	10	(254)	25.4	(645)	57.00	(1448)	18.88	(480)	37.50	(953)	89.50	(17)
AL5424-2306FT/AC	53.87	(1368)	23.93	(608)	28.87	(733)	22.8	(578)	6.1	(155)	56.87	(1444)	26.93	(684)	33.75	(857)	104.30	(15)
AL5430-0418AC	57.20	(1453)	30.60	(777)	24.70	(627)	4.6	(117)	18.1	(460)	58.40	(1483)	33.90	(861)	26.40	(671)	95.60	(12)
AL5430-3006AC	53.88	(1369)	29.81	(757)	35.93	(913)	29.9	(759)	6.1	(154)	56.88	(1445)	32.81	(833)	39.62	(1006)	114.00	(18)
AL5545-0605AC	55.50	(1410)	45.50	(1156)	13.19	(335)	6.3	(206)	5.1	(130)	58.50	(1486)	48.50	(1232)	15.00	(381)	102.00	(7)
AL5545-0623AC-HL	55.50	(1410)	45.50	(1156)	30.62	(778)	6.3	(206)	226	(574)	58.50	(1486)	48.50	(1232)	34.25	(870)	157.00	(16)
AL5545-2305AC	55.50	(1410)	45.50	(1156)	27.92	(709)	22.8	(579)	5.1	(130)	58.50	(1486)	48.50	(1232)	31.61	(803)	145.30	(14)

Weights shown is the empty container weight, with handles and hardware in the standard configuration.
Outside dims do not include a box.

SINGLE LID SIZE LIST

OCT 2017 | Rev. 1

CASE SIZE	INSIDE DIMENSIONS						EXTERIOR DIMENSIONS											
	L		W		H		BASE		LID		L		W		H		WEIGHT	
	in	(mm)	in	(mm)	in	(mm)	in	(mm)	in	(mm)	in	(mm)	in	(mm)	in	(mm)	lbs	(kg)
AL5545-2323AC	55.50	(1410)	45.50	(1156)	45.36	(1152)	22.8	(579)	22.6	(573)	58.50	(1486)	48.50	(1232)	49.05	(1246)	179.00	(22)
AL5616-0604	56.43	(1433)	16.25	(413)	10.07	(256)	5.9	(149)	4.2	(107)	59.43	(1510)	19.25	(489)	12.76	(324)	42.40	(6)
AL5733-0906FT/AC	56.60	(1438)	33.00	(838)	13.20	(335)	9.1	(230)	16	(406)	60.00	(1524)	36.00	(914)	22.80	(579)	76.60	(10)
AL5733-0916FT/AC	56.87	(1444)	32.75	(832)	25.06	(637)	9.1	(230)	9.1	(230)	59.87	(1521)	35.75	(908)	35.63	(905)	123.40	(16)
AL5757-0806FT/AC	56.89	(1445)	56.89	(1445)	16.87	(428)	10.68	(271)	8.24	(209)	60.00	(1524)	60.00	(1524)	21.42	(544)	103.00	(10)
AL5824-1119AC	58.62	(1489)	24.12	(613)	30.18	(767)	11	(279)	19.2	(487)	61.62	(1565)	27.12	(689)	33.87	(860)	76.50	(15)
AL5834-0111	58.24	(1479)	34.24	(870)	12.75	(324)	1.75	(44)	11.0	(279)	61.25	(1556)	37.25	(946)	16.25	(413)	109.00	(7)
AL5834-0128FT/AC/HL	58.31	(1481)	34.25	(870)	29.55	(751)	1.6	(41)	27.9	(709)	61.31	(1557)	37.25	(946)	32.87	(835)	126.00	(15)
AL5834-0140FT/AC	58.31	(1481)	34.25	(870)	41.62	(1057)	1.6	(41)	40	(1016)	61.31	(1557)	37.25	(946)	45.25	(1149)	134.00	(21)
AL5834-0711	58.24	(1479)	34.24	(870)	18.75	(476)	7.75	(197)	11.0	(279)	61.25	(1556)	37.25	(946)	22.25	(565)	124.00	(10)
AL5834-0728FT/AC/HL	58.31	(1481)	34.25	(870)	35.55	(903)	7.6	(194)	27.9	(709)	61.31	(1557)	37.25	(946)	38.87	(987)	138.90	(18)
AL5834-0740FT/AC	58.31	(1481)	34.25	(870)	47.62	(1210)	7.6	(194)	40	(1016)	61.31	(1557)	37.25	(946)	51.19	(1300)	141.00	(23)
AL5834-1011	58.24	(1479)	34.24	(870)	20.69	(526)	9.69	(246)	11.0	(279)	61.25	(1556)	37.25	(946)	26.25	(667)	132.00	(12)
AL5834-1028AC	58.30	(1481)	34.30	(871)	41.00	(1041)	9.79	(248)	27.9	(709)	61.30	(1557)	37.30	(947)	43.50	(1105)	105.90	(20)
AL5834-1040AC	58.30	(1481)	34.30	(871)	47.60	(1209)	9.79	(248)	40.3	(1024)	61.30	(1557)	37.30	(947)	51.20	(1300)	142.40	(23)
AL5910-0604	59.06	(1500)	9.91	(252)	10.30	(262)	6.2	(157)	4.1	(105)	62.06	(1576)	12.91	(328)	12.25	(311)	31.60	(6)
AL5924-1009AC	59.30	(1506)	24.30	(617)	19.30	(490)	10.1	(462)	9.2	(234)	62.30	(1582)	27.30	(693)	21.60	(549)	61.30	(10)
AL5924-1018AC	59.25	(1505)	24.25	(616)	28.32	(719)	10.1	(257)	18.2	(462)	62.25	(1581)	27.25	(692)	29.69	(754)	74.00	(13)
AL6242-2408	61.97	(1574)	42.31	(1075)	31.94	(811)	23.99	(609)	7.95	(201)	65.98	(1676)	45.67	(1160)	39.59	(1006)	127.00	(18)
AL6638-0605AC	67.25	(1708)	37.75	(959)	8.94	(227)	5.94	(151)	4.94	(126)	71.00	(1803)	18.25	(464)	17.13	(435)	58.50	(8)
BL6752-0805AC/HL	67.43	(1713)	51.87	(1317)	13.16	(334)	8	(204)	5.1	(130)	70.43	(1789)	54.87	(1394)	18.66	(474)	145.00	(8)
AL6815-1005	68.00	(1727)	15.25	(387)	15.32	(389)	10.1	(257)	5.2	(132)	71.00	(1803)	18.25	(464)	17.13	(435)	58.50	(8)
AL6815-1032AC	67.70	(1720)	14.90	(378)	42.00	(1067)	10.1	(257)	31.9	(810)	70.80	(1798)	18.00	(457)	43.50	(1105)	78.00	(20)
AL6821-1105	68.38	(1737)	21.38	(543)	16.44	(418)	11.19	(284)	5.25	(133)	71.50	(1816)	24.50	(622)	19.94	(506)	65.20	(9)
AL6912-1003	69.37	(1762)	12.00	(305)	14.09	(358)	10.5	(266)	3.6	(91)	72.37	(1838)	15.00	(381)	16.28	(414)	42.00	(7)
AL7007-0403AC	70.25	(1784)	7.00	(178)	7.00	(178)	4	(102)	3	(76)	73.25	(1861)	10.00	(254)	9.75	(248)	30.00	(4)
AL7430-0418AC	73.78	(1874)	29.78	(756)	22.65	(575)	4.64	(118)	18.02	(458)	77.00	(1956)	33.00	(838)	26.25	(667)	112.00	(12)
AL7819-0805	78.87	(2003)	19.43	(494)	13.28	(337)	8.3	(210)	5	(128)	80.75	(2051)	22.43	(570)	14.97	(380)	60.80	(7)
AL7819-0808AC	78.87	(2003)	19.43	(494)	16.28	(414)	8.3	(210)	8	(204)	80.75	(2051)	22.43	(570)	17.97	(456)	61.80	(8)
BL8024-3009AC	80.43	(2043)	24.43	(621)	39.24	(997)	30.1	(765)	9.1	(232)	84.43	(2145)	28.43	(722)	43.81	(1113)	159.50	(20)
BL8232-0705AC	81.87	(2079)	31.93	(811)	12.37	(314)	7.3	(184)	5.1	(130)	85.87	(2181)	35.93	(913)	16.81	(427)	122.30	(8)

Weights shown is the empty container weight, with handles and hardware in the standard configuration.

Outside dims do not include a box.

SINGLE LID SIZE LIST

OCT 2017 | Rev. 1

CASE SIZE	INSIDE DIMENSIONS						EXTERIOR DIMENSIONS											
	L		W		H		BASE		LID		L		W		H		WEIGHT	
	in	(mm)	in	(mm)	in	(mm)	in	(mm)	in	(mm)	in	(mm)	in	(mm)	in	(mm)	lbs	(kg)
BL8232-0905AC	81.87	(2079)	31.93	(811)	14.12	(359)	9	(229)	5.1	(130)	85.87	(2181)	35.93	(913)	18.56	(471)	128.00	(8)
BL8240-1623FT/AC	81.75	(2076)	40.00	(1016)	38.87	(987)	16.1	(409)	22.8	(578)	85.75	(2178)	44.00	(1118)	48.06	(1221)	229.20	(22)
BL8537-2906AC	85.23	(2165)	37.73	(958)	35.23	(895)	29.2	(741)	6	(153)	89.23	(2266)	41.73	(1060)	39.60	(1006)	190.00	(18)
BL9024-1113FT/AC	91.00	(2311)	24.19	(614)	24.94	(633)	11.6	(295)	13.3	(339)	95.00	(2413)	28.19	(716)	33.26	(845)	147.20	(15)
BL9053-1035AC	90.00	(2286)	53.00	(1346)	45.50	(1156)	10.3	(260)	35.3	(895)	94.00	(2388)	57.00	(1448)	50.00	(1270)	278.00	(23)
BL9836-1105AC	97.80	(2484)	35.90	(912)	16.10	(409)	11	(279)	5.1	(130)	101.80	(2586)	39.90	(1013)	20.79	(528)	190.00	(9)
BL9836-3705AC	97.80	(2484)	35.90	(912)	42.10	(1069)	37	(940)	5.1	(130)	101.80	(2586)	39.90	(1013)	46.79	(1188)	242.00	(21)
BL11433-0527AC	114.00	(2896)	33.00	(838)	32.62	(829)	5.4	(137)	27.3	(692)	118.00	(2997)	37.00	(940)	34.31	(871)	210.00	(16)
AL13115-0805FT	131.00	(3327)	15.00	(381)	13.25	(337)	8.3	(210)	5	(127)	134.00	(3404)	18.00	(457)	17.97	(456)	97.00	(8)















GRAB AND ROLL SINGLE-LID																		
GR1815-0603	17.90	(455)	14.30	(363)	11.10	(282)	8.4	(213)	3.1	(79)	21.00	(533)	17.50	(445)	13.10	(333)	19.00	(6)
GR2216-0305	21.80	(554)	16.00	(406)	9.90	(251)	3.0	(76)	5.3	(135)	25.00	(635)	19.00	(483)	12.13	(308)	23.00	(6)
GR2221-0405	21.80	(554)	20.80	(528)	10.70	(272)	6.1	(155)	4.9	(124)	24.38	(619)	23.44	(595)	12.38	(314)	25.00	(6)

INTERSTACKING SINGLE-LID																		
IS2117-1103	21.00	(533)	17.00	(432)	14.00	(356)	11.7	(297)	2.9	(74)	24.00	(610)	20.00	(508)	16.00	(406)	20.00	(7)
IS2917-1103W	29.00	(737)	17.00	(432)	14.00	(356)	11.7	(297)	2.9	(74)	32.00	(813)	20.00	(508)	16.00	(406)	26.00	(7)
IS3721-1103W	37.00	(940)	21.00	(533)	14.00	(356)	11.7	(297)	2.9	(74)	40.00	(1016)	24.00	(610)	16.00	(406)	38.00	(7)
IS4517-1103W	45.00	(1143)	17.00	(432)	14.00	(356)	11.7	(297)	2.9	(74)	48.00	(1219)	20.00	(508)	16.00	(406)	38.00	(7)
IS4521-2303	45.00	(1143)	21.00	(533)	26.00	(660)	23.5	(597)	2.9	(74)	48.00	(1219)	24.00	(610)	32.00	(813)	72.00	(15)
IS4537-2303	45.00	(1143)	37.00	(940)	26.00	(660)	23.5	(597)	2.9	(74)	48.00	(1219)	40.00	(1016)	32.00	(813)	93.00	(15)

Weights shown is the empty container weight, with handles and hardware in the standard configuration.
Outside dims do not include a box.

AVAILABLE OPTIONS

					
Airtight/Watertight	Card Holder	Casters	Edge Casters	Extra Handles	Grab'N Roll™
					
Combination Lock	FlangeMount™ Cases	Forklift Bash Plates	Forklift Provision, Skid Runners	Front Labels	Stainless Steel Hardware
					
Stainless Steel Black Passivated Finish Hardware	Hinged Lid	Lockable Cable Catch	Lockable Padlock Hasp	Custom Stenciling	Humidity Indicator
					
ID Plate	Standard and ATA Labels	Lifting Rings/Tie Down Rings	Breather Valve Desiccant		

COLORS	
	Gray – 133 Fed Std# 26270
	Tan – 250 Fed Std# 20372
	Blue – 135(lt) Pantone# 292U
	White – 132 Fed Std# 27925
	Yellow – 136 Pantone# 012U
	Green – 138(forest) Fed Std# 24052
	Orange – 134 Fed Std# 12197
	Maroon – 197 Pantone# 202U
	Yellow – 131 Fed Std# 23538
	Blue – 101(dk) Fed Std# 25052
	Black – 032 Fed Std# 27040
	Red – 130 Fed Std# 21105
	Purple – 129 Pantone# 245U
	Olive Drab – 137 Fed Std# 34096

Some options are not available on all case sizes and availability is subject to change at manufacturer's discretion.
Case colors/options may differ slightly from printed versions.

[View other first aid kits made by Pelican on our website.](#)