

Date	DESCRIPTION	Rev
8/2/2013	INITIAL RELEASE	A

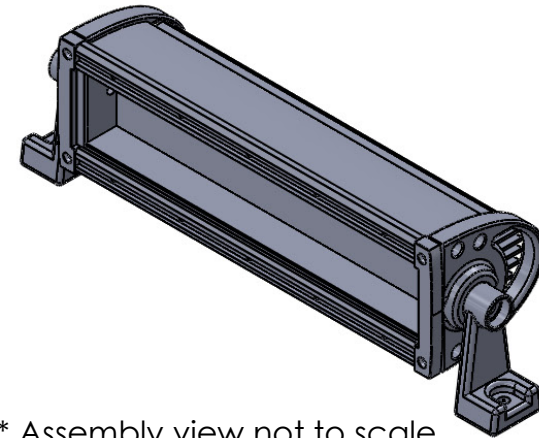

* Assembly view not to scale

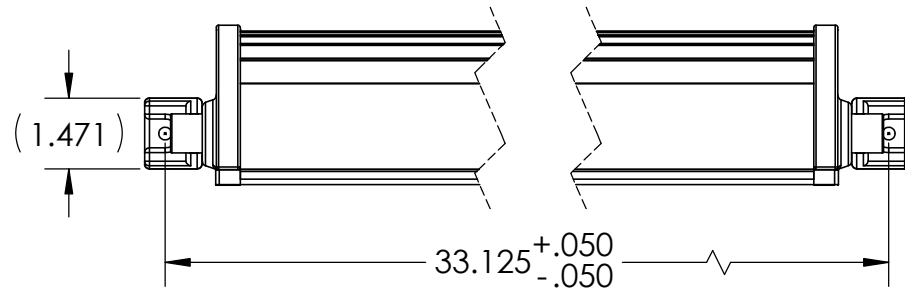
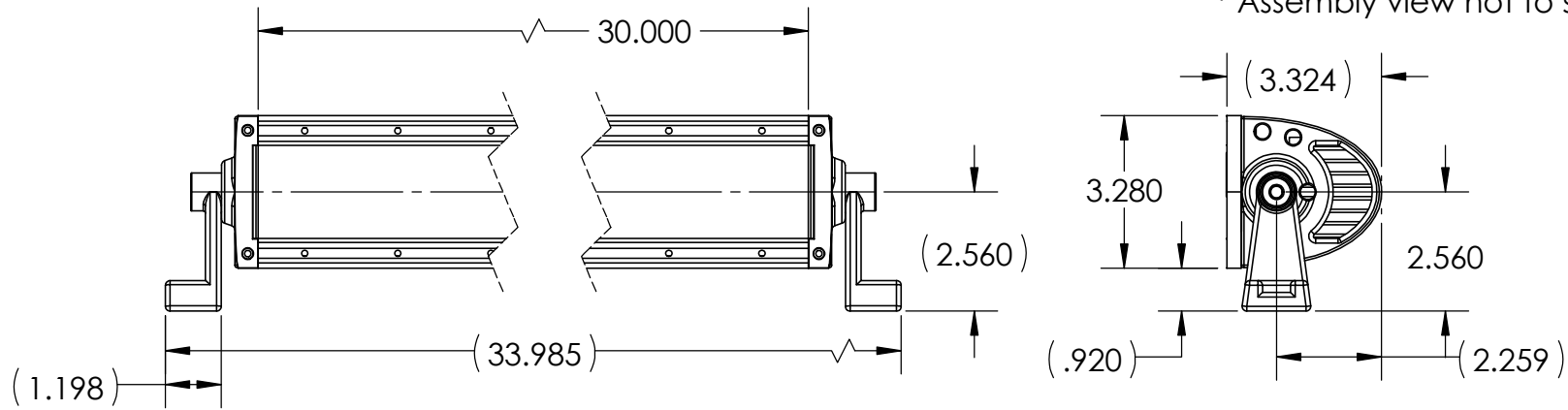

Notes		SIRIUS LED by MotoAlliance	
Finish: Mar/UV Resistant Paint		TITLE: 30" Double Row Light Bar	
Material: Aluminum			
Unless Otherwise Specified:	PROPRIETARY AND CONFIDENTIAL	SIZE	DWG. NO.
.XXX = 0.010 .XX = .015 .X = .03	THE INFORMATION CONTAINED IN THIS DRAWING IS THE SOLE PROPERTY OF MotoAlliance Inc. ANY REPRODUCTION IN PART OR AS A WHOLE WITHOUT THE WRITTEN PERMISSION OF MotoAlliance Inc. IS PROHIBITED.	A	LED-D30
XX° = +/- .05° X° = +/- .5°			REV A
		SCALE: 1:4	SHEET 1 OF 1