



THUMPER FAB

Aluminum Audio Roofs • Roll Cages • UTV Accessories

Can-Am Defender Bed Rack

SKU: TF041901

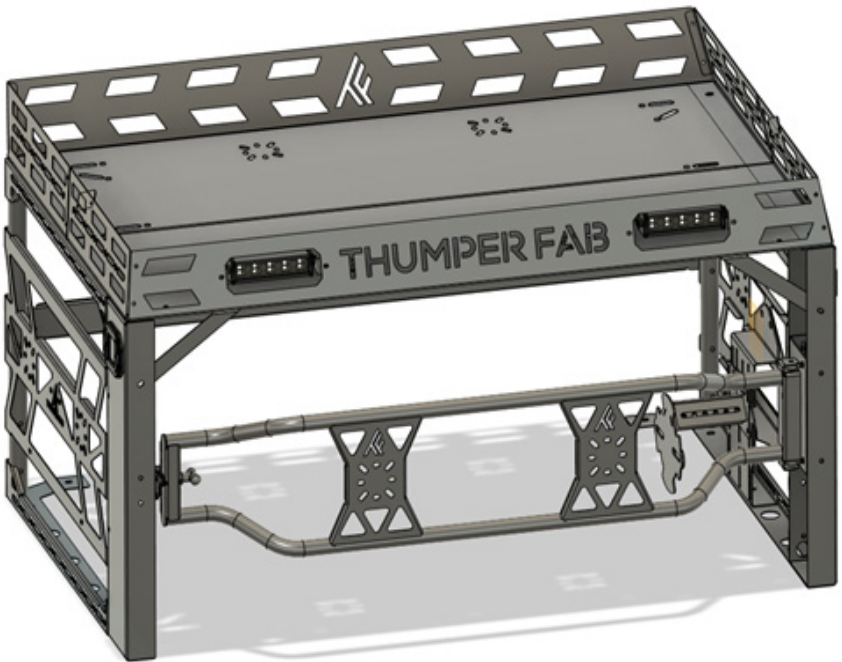

Thumper Fab

5103 Elysian Fields Rd, Marshall, TX 75672

Customer Service: 903-472-0928

www.thumperfab.com

Ver. 0622

Can-Am Defender Bed Rack

P/N: TF041901



PARTS

REF	QTY	DESCRIPTION
1	1	Rear Column - DR
2	1	Rear Column - PA
3	1	Front Column - DR
4	1	Front Column - PA
5	2	Light Cube Cover
6	1	Lower Main Rail - DR
7	1	Lower Main Rail - PA
8	1	Middle Rail - DR
9	1	Middle Rail - PA
10	1	Upper Main Rail - DR
11	1	Upper Main Rail - PA
12	1	Sway Support - DR
13	1	Sway Support - PA
14	1	Rear Brace
15	1	Upper Rack - REAR
16	1	Upper Rack - FRONT
17	2	Upper Rack Accent Panel
18	2	Upper Rack Connection Bracket

HARDWARE

REF	QTY	HARDWARE KIT
A	19	M6-1.0 x 16mm Flange Bolts
B	19	M6-1.0 x 16mm Flange Lock Nuts
C	16	M8-1.25 x 55mm Flange Bolts
D	20	M8-1.25 x 20mm Flange Bolts
E	40	M8-1.25 Flanged Lock Nuts
F	2	Cube Light Cover RWB
G	8	1/4-20 x 1/2 SS Button Heads
H	8	1/4 1/2 SS Flat Washers
I	8	1/4 x 20 SS Lock Nuts
J	4	M8-1.25 Flanged Lock Nuts
K	4	5/16" Washers
L	4	Washers

BEFORE YOU BEGIN

If you do not feel comfortable installing your **Thumper Fab** Bed Rack please see your nearest Can-Am® Dealer for installation.

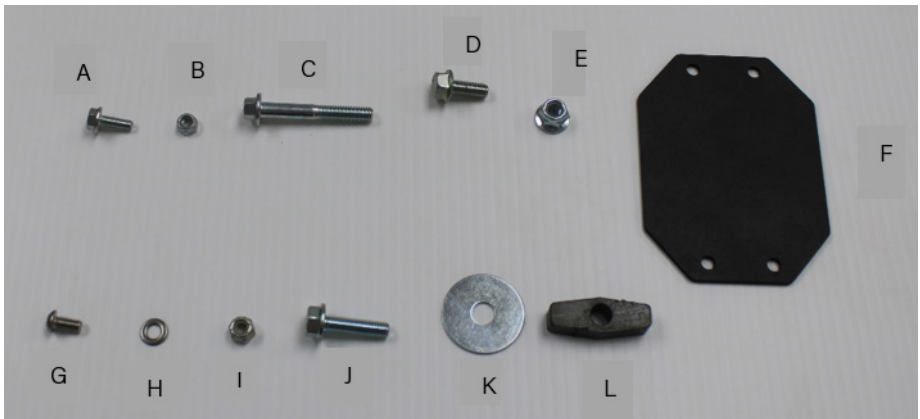

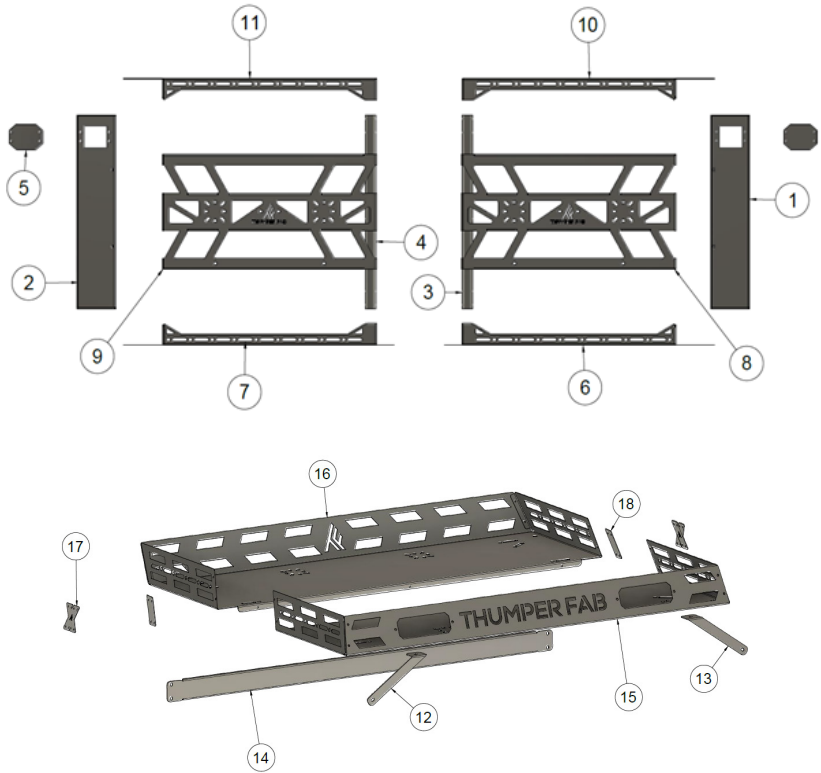

INSTALLATION INSTRUCTIONS

TOOLS

Assemble Each Side

These instructions will be followed for drivers and passengers side, they can be completed consecutively or individually. Separate and stage materials, this will be easiest on a table (FIG 1).



- 10mm Socket
- 13mm Socket
- 7/16" Socket
- 10mm Wrench
- 13mm Wrench
- 7/16" Wrench
- Ratchet
- Rubber Mallet

FIG 1 - Separate & Stage Materials for Driver and Passengers Side

INSTALLATION INSTRUCTIONS

Hand Tighten Hardware for the Side Panels of Bed Rack

Assemble lower main rail - DR (6), rear column -DR (1), front column - DR (3), middle rail - DR (8) and upper main rail - DR (10). Using 16 X M8-1.25 x 55mm flange bolts (H), 12 X M8-1.25 x 20mm flange bolts (I) & 28 X M8-1.25 x flange lock nuts (J), loosely attach side panel of bed rack (FIG 2).



FIG 2 - Hand Tighten Hardware for Each Side

Once loosely assembled, place side rails on top of Defender Bed rail for mounting (FIG 3).



FIG 3 - Put Loosely Assembled side Rails on Bed

INSTALLATION INSTRUCTIONS

Insert Washers

Using factory provided mounting holes fit the washers (L) in the four corners of the bed. Once fit securely, raise the bed for easier fastening of the hardware (FIG 4).



FIG 4

Secure Washers using Bolt Assembly in Front Corners of Bed

Using the 7/16" socket & 7/16" wrench, tighten in this order: 1 X M8-1.25 x 30mm flanged bolt (J), 1 X washer (L), 1 X 5/16" washer (K) & 1 X M8-1.25 flanged lock nut (E) tighten on both front corners of the bed. Once front 2 mounting fasteners are hand tight, lower bed for remainder of install (FIG 5).

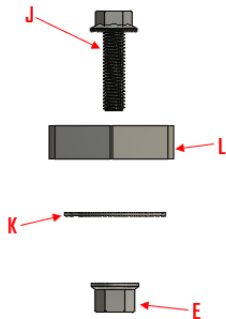

FIG 5 - Using 7/16" Socket & 7/16" Wrench Install Washers to Front Corners of Bed

INSTALLATION INSTRUCTIONS

Remove the Two Middle Rail Screws to Fasten Rear Brace

Remove the 4 X M8-1.25 x 55mm Flange Bolts (H) and 4 X M8-1.25 flange lock nuts (J) to be able to install the rear brace (14) (FIG 6).

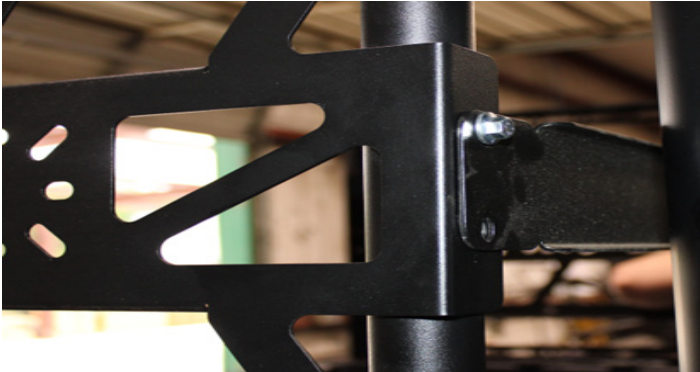

FIG 6 - Rear Brace (14) Connects Driver & Passenger Side

Fasten Rear Brace

Using the rear brace (14), connect both sides using 4 X M8-1.25 x 55mm flange bolts (H) and 4 X M8-1.25 flange lock nuts (J) hand tighten (FIG 7).



FIG 7 - Connect the Rear Brace to the Bed Rack using a 13mm Socket and 13mm Wrench

INSTALLATION INSTRUCTIONS

Install Upper Basket

Place the upper rack - FRONT (16) on top of the bed rack towards the front of the unit. Secure into place using 2 X M8-1.25 x 20mm flange bolts (I) & 2 X M8-1.25 flange lock nuts (J). Next, place the upper rack - REAR (15) behind the upper rack - FRONT (16) using 2 X M8-1.25 x 20mm flange bolts (I) & 2 X M8-1.25 flange lock nuts (J)(FIG 15). Once hand tight install sway supports (12 & 13) using 4 X M8-1.25 x 20mm flange bolts (I) and 4 X M8-1.25 flange lock nut (J) (FIG 16).



FIG 15 - Secure Upper Front and Rear Racks using 13mm Socket and 13mm Wrench



FIG 16 - Use 13mm Socket and 13mm Wrench to install Sway Supports (12 & 13)

Fasten front and rear racks from the underside using 3 X M6-1.0 x 16mm flange bolts (A) and 3 X M6-1.0 flange lock nuts (B). Using 10mm socket and 10mm wrench to fasten the upper rack connection brackets (18) and the upper rack accent panels (17) with 8 X M6-1.0 x 16mm flange bolts (A) and M6-1.0 lock nuts (B). Tighten all bed rack bolts using 13mm Socket and 13mm Wrench (FIG 17).

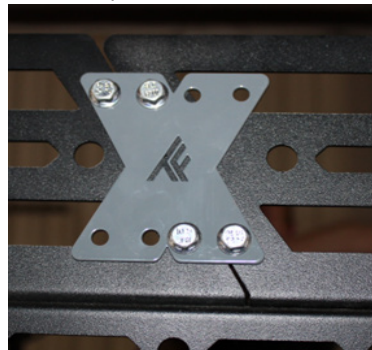

FIG 17 - Fasten together Upper Rack - FRONT and Upper Rack - REAR using 10mm Socket and 10mm Wrench

ACCESSORIES

PARTS

REF	QTY	DESCRIPTION
LIGHT KIT (INSTRUCTIONS IN BOX)		
1	2	Cube Lights
2	2	6" Light Bar
3	1	Rack Harness
4	1	Bike Harness
SPARE TIRE CARRIER		
5	1	Tire Mount Assembly
6	1	Frame Mount Assembly
7	1	Tire Adjuster Mount Brace
8	1	Tire Height Adjuster
9	1	Tire Diameter Adjuster Mount
REAR DOOR		
10	1	Rear Door
11	1	Latch A
12	1	Latch B
13	1	Latch C
14	1	Mount Hinge

HARDWARE

REF	QTY	DESCRIPTION
FOR OPTIONAL SPARE TIRE CARRIER		
A	16	M8-1.25 x 20mm Flange Bolt
B	16	M8-1.25 Flange Lock Nut
C	2	M12-1.5 Hex Cap Screw
D	2	M12-1.5 Wheel Nut
E	4	M8 Flat Washer
FOR OPTIONAL REAR DOOR		
F	2	M6-1.0 x 16mm Flange Bolts
G	2	M6-1.0 Flange Lock Nuts
H	6	M8-1.25 20mm Flange Bolts
I	6	M8-1.25 Flanged Lock Nuts
J	2	3/8"-24 Hiem Joints
K	2	3/8"-24 Jam Nuts
L	2	3/8"-16 x 1-1/2" Flange Head
M	2	3/8"-16 Lock Nut
N	1	Retractable Spring Plunger
O	2	1 1/4" Tubing Plugs

TOOLS - Rear Door

- 14mm Socket
- 9/16" Socket
- 14mm Wrench
- 7/8" Wrench
- 9/16" Wrench
- 11/16" Wrench

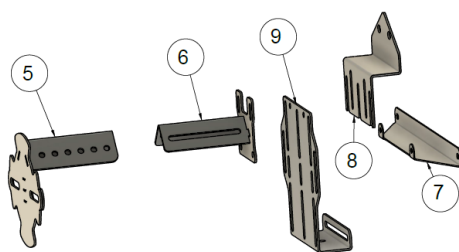

Spare Tire Holder

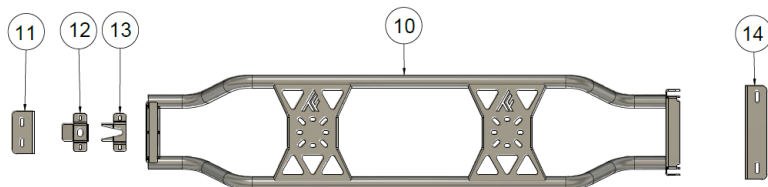

Rear Door

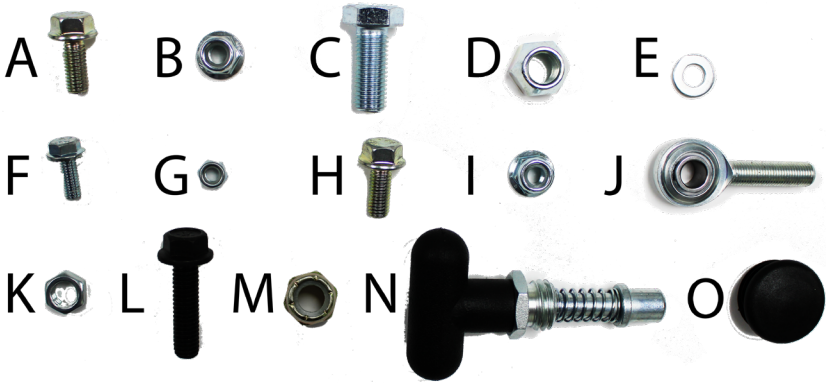

ACCESSORY INSTALLATION INSTRUCTIONS

Optional Spare Tire Carrier Install

Using 8 X M8-1.25 x 20mm flange bolts (A) and 8 X M8-1.25 flange lock nuts (B) assemble the tire adjuster mount brace (7), tire height adjuster (8), and tire diameter adjuster mount (9) (FIG 17).



FIG 17 - Assemble Spare Tire Mount using 13mm Wrench and 13mm Socket

Using the remaining 8 X M8-1.25 x 20mm flange bolts (A), and 8 X M8-1.25 flange lock nuts (B) to fasten the frame mount assembly (6) to the tire mount assembly (5). Use the 2 X M12-1.5 hex cap screws (C) and 2 X M12-1.5 wheel nuts (D) to attach tire to mount assembly (5)(FIG 18).

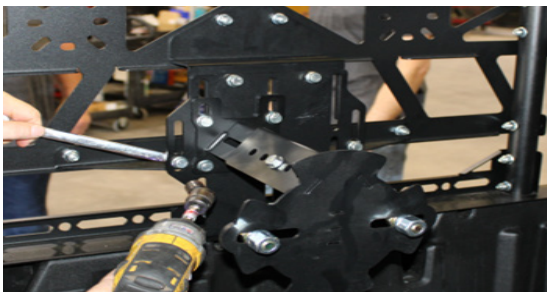

FIG 18 - Assemble Spare Tire Mount using 13mm Wrench and 13mm Socket

INSTALLATION INSTRUCTIONS

Optional Rear Door

Remove the 2 rear middle rail bolts on both sides. Connect latch A (**11**), latch B (**12**) & latch C (**13**) with slots centered use 2 X M6-1.0 x 16mm flange bolts (**A**) and 2 X M6-1.0 lock nuts (**B**) and 10mm socket and 10mm wrench. Insert the new piece (latch) in to the driver side rear column (**1**), loosley fasten using 4 X M8-1.25 x 20mm flange bolts (**H**) and M8-1.25 flange lock nuts (**I**) (**FIG 19**).

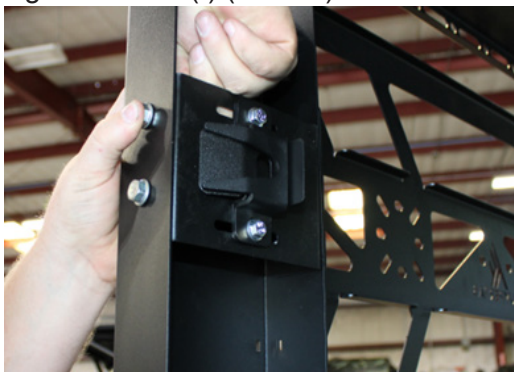

FIG 19 - Use 13mm Socket and 13mm Wrench to fasten latch assembly to Driver Rear Column

Secure Hiem Joints

Thread 2 X 3/8"-24 hiem joints (**J**) and 2 X 3/8"-24 jam nuts (**K**) into weldnuts provided in mount hinge (**14**). **Do Not Tighten!!** Using the 6 X M8-1.25 x 20mm flange bolts (**H**) and 6 X M8-1.25 flange lock nuts (**I**) fasten the mount hinge (**14**) to the passenger rear column using a 13mm socket and 13 mm wrench (**FIG 18**).



FIG 18 - Loosley install Mount Hinge (14) using 13mm Socket and 13mm Wrench

INSTALLATION INSTRUCTIONS

Installation of Rear Door

Place the rear door (10) into place on the hiem joint and test fit door swinging path using 2 X 3/8-16 x 1-1/2" flange head bolts (L) and 2 X 3/8-16 lock nuts (M). Adjustment of hiem joints (J) will need to be performed to align the retractable spring plunger (N) with the latch assembly, this may take several attempts, back out lower hiem and screw in upper hiem to adjust door height at latch (FIG 19).

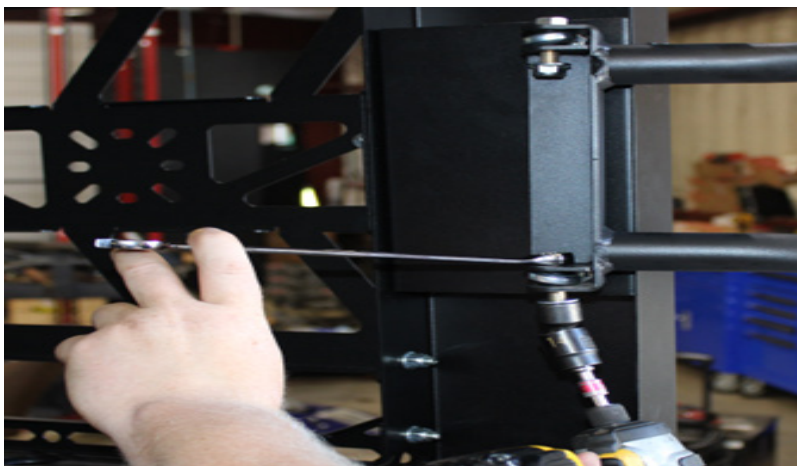

FIG 19 - Use 9/16" Socket & 9/16" Wrench to tighten Door Mounting Bolts & 11/16" Wrench for 2 X 3/8-24" Jam Nuts (K)

Retractable Spring Plunger

Install the retractable spring plunger (N). Once door is aligned properly using adjustment of hiem joints (J) the door should easily swing and close properly. Tighten all remaining hardware and install 2 X plastic tubing plugs in the end of the driver side door (O) using rubber mallet (FIG 20 & 21).

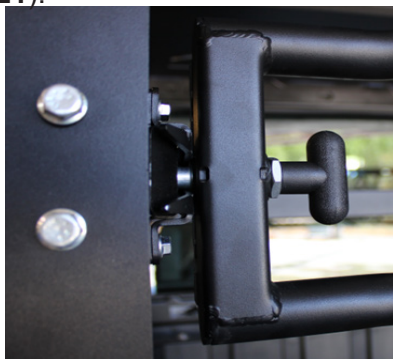

FIG 20 - Install Retractable Spring Plunger (N) using 7/8" Wrench



FIG 21 - Install Plastic Tubing Plugs (O)

If you're enjoying your Defender Bed Rack, check out these other Thumpin' accessories!



TF040902 Hidden Gun Mount

TF40702 Defender Nerf Rails (3 Seat)

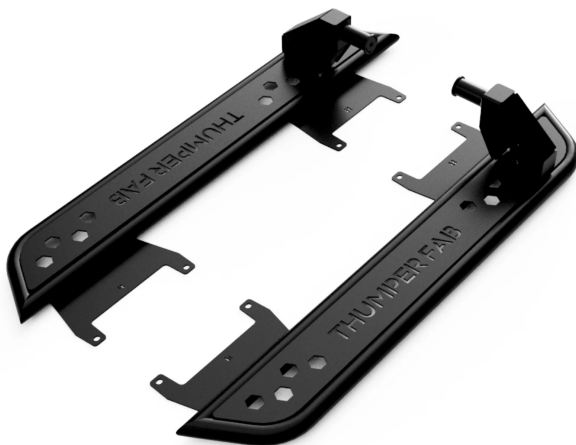

The installation of products sold or manufactured by Thumper Fab including, but not limited to suspension components such as lift kits, control arms, frame stiffener kits, roofs, roll cages, and tires that exceed the original specifications for the vehicle, may change the vehicle's center of gravity and handling characteristics both on- and off-road. You are aware that the installation of tires that are larger than original vehicle specifications may reduce the effectiveness of the braking system. Use of these products may place added stress to the original factory vehicle components which could cause them to weaken or possibly fail.

Products sold or manufactured by Thumper Fab are intended for off-road use only. Operation of a vehicle modified with these products on a road could result in serious bodily injury or death, and such operation may violate the laws of your state or municipality. You agree to operate your vehicle exclusively in the manner intended by the vehicle manufacturer. You agree that failure to safely and reasonably operate your vehicle could result in serious bodily injury or death, and that, as a result of installation of this product(s) to your vehicle, extreme care must be taken to prevent vehicle rollover or loss of control, which may be more likely to occur as a result of said modifications. You will avoid unsafe maneuvers, including sudden sharp turns or other abrupt maneuvers, which could make a vehicular accident more likely. You understand that Thumper Fab is not responsible or liable for any damages or any injuries to yourself or your passengers that could occur upon possible accidents due to driver error, incorrect installations, bad judgment, incompatibility with other aftermarket accessories or natural disasters to the fullest extent allowable by law. You will have all vehicle occupants fasten seatbelts, if equipped, and wear proper safety equipment, such as DOT approved helmet and eye protection prior to operating the vehicle. You understand and acknowledge that failure to wear proper safety equipment may increase the risk of serious bodily injury or death to yourself and any passengers.

Proper installation of products sold or manufactured by Thumper Fab requires knowledge of the factory recommended procedures for removal and installation of original equipment components. Installation of these products without proper knowledge and experience may affect the performance of these components and the safety of the vehicle and cause serious bodily injury or death.

It is strongly recommended that a certified mechanic familiar with the installation of similar components perform the product(s) installation.

Prior to installing any products sold or manufactured by Thumper Fab, you will perform or cause to be performed an inspection of their vehicle to confirm its condition is suitable for the installation of these products. A proper inspection of the vehicle includes confirmation that the vehicle has not been in a collision and is free of corrosion. If the vehicle is suspected to have been in a collision or misused, or is otherwise unsuitable for modification, you will not install the product(s). You will continue to inspect the vehicle prior to each use to confirm its condition is suitable for its intended use, and you acknowledge that the failure to do so may result in serious bodily injury or death, as well as damage to the vehicle itself.

You will install any warning labels provided with the product so it may be prominently seen by yourself and all passengers. You will notify all passengers of the modifications performed to your vehicle prior to operation.

Insurance companies may handle coverage of a modified vehicle differently. Please check with your insurance carrier prior to modifying the vehicle to ensure your coverage remains sufficient.

Installation of this product(s) may void your vehicle warranty. If this is a concern, please check with the manufacturer or dealer before purchase or installation of this product(s).



THUMPER FAB

Thumper Fab

5103 Elysian Fields Rd, Marshall, TX 75672

Customer Service: 903-472-0928

www.thumperfab.com