



motoalliance

MotoAlliance Winch Mount

MA11939

Kawasaki Mule Pro FXT

Thank you for purchasing our MotoAlliance winch mount(s). You now own a premium custom winch mount which allows you to use your winch with your UTV / SxS. Please note the following instructions and heed all warnings:

- Please use common sense when operating your UTV / SxS
- Read your Winch Operator's Manual and all other Operator Manuals, including warning labels, before operating your UTV / SxS
- Be observant of moving parts causing entanglement; use extreme caution!

SEVERE INJURY OR DEATH MAY RESULT IF YOU ARE NEGLIGENT.

Please verify that all hardware and parts are included in your package.

Kit Content:

Item	Description	QTY
1	Winch Mount Base Plate	1
2	Rear Bracket	2
3	3/8"-16 x 1" Serrated Flange Bolt	4

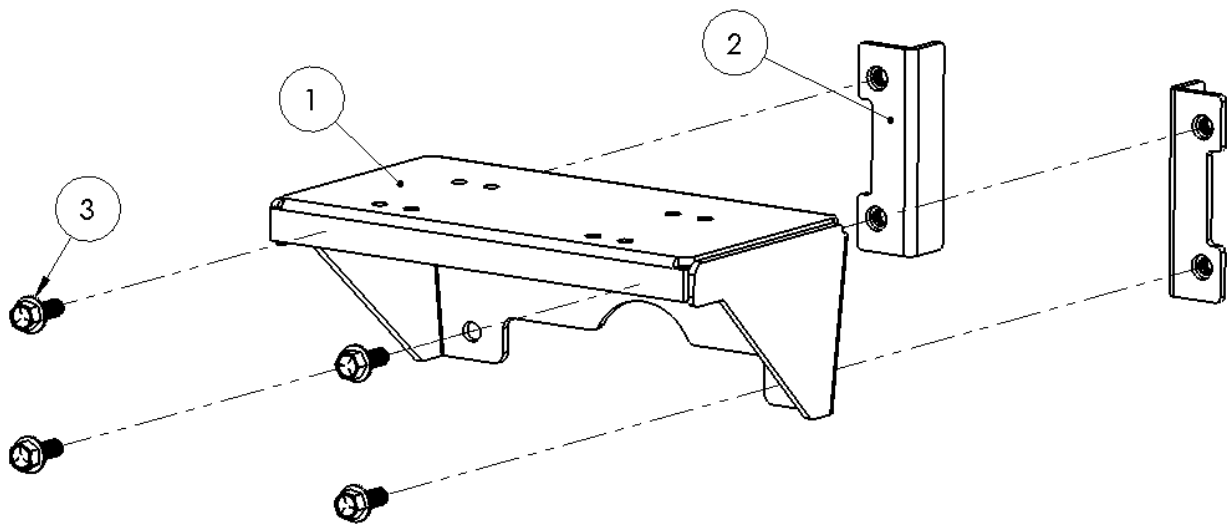

MA11939 Winch Mount Assembly View

- 1) Remove the front bumper.
 - a. Remove the three lower bolts found at the bottom of the front bumper.
 - b. Remove the two upper mounting bolts found to the inside of the head lights as shown in Figure 1.

Note: The upper mounting bolts include a spacer. Keep all hardware together for future use.



Figure 1

2. Position the Winch Mount Base Plate over the front frame rails as shown in Figure 2.

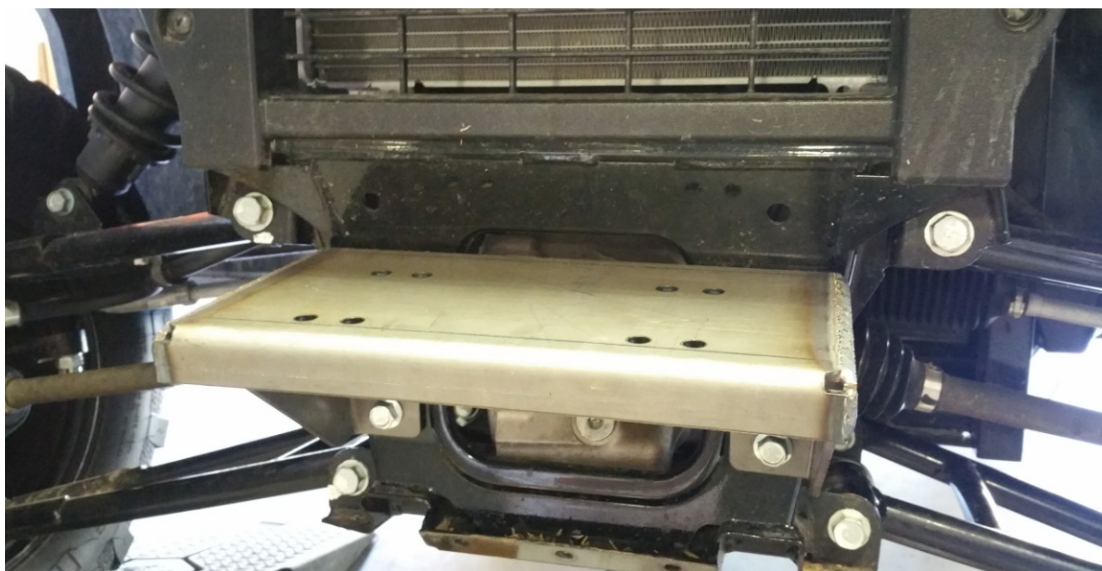

Figure 2

3. Place the Rear Support Brackets behind the front frame rails so that the notches in the Rear Support Brackets face toward the outside of the vehicle as shown in the Winch Mount Assembly View and Figure 3. Use the 3/8"x1" bolts to secure the Winch Mount Base Plate to the Rear Support Brackets.

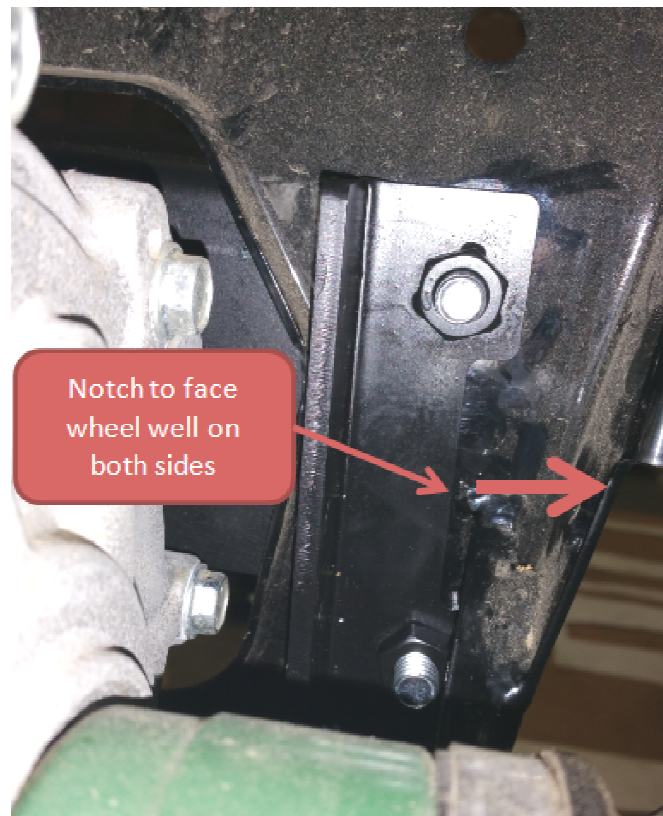

Figure 3

4. All Viper winches include two sets of M8 hardware, one set is 20mm long and one is 25mm long. Use the four (4), 25mm hex bolts to mount the Winch and Universal Fairlead Bracket, included in all Viper winches, to the Winch Mount Base Plate, as shown in Figure 4.

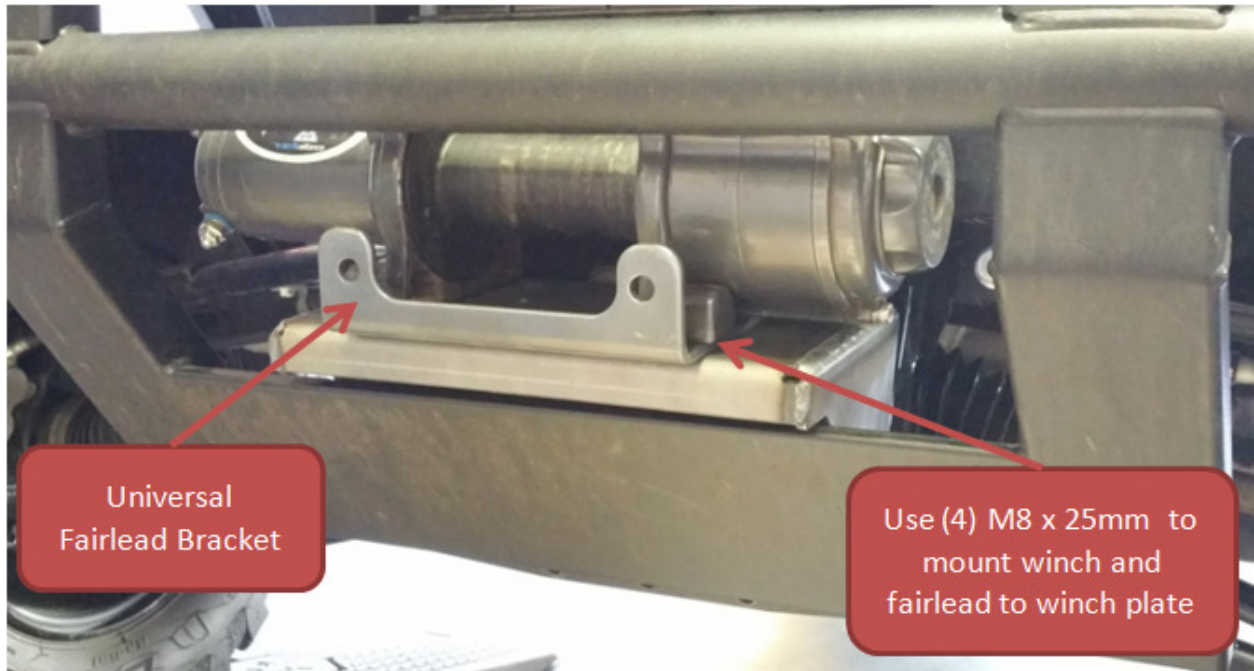

Figure 4

5. Reinstall the bumper in reverse order. Note the orientation of the upper mounting bolts and the position of the spacer as shown in Figure 5.

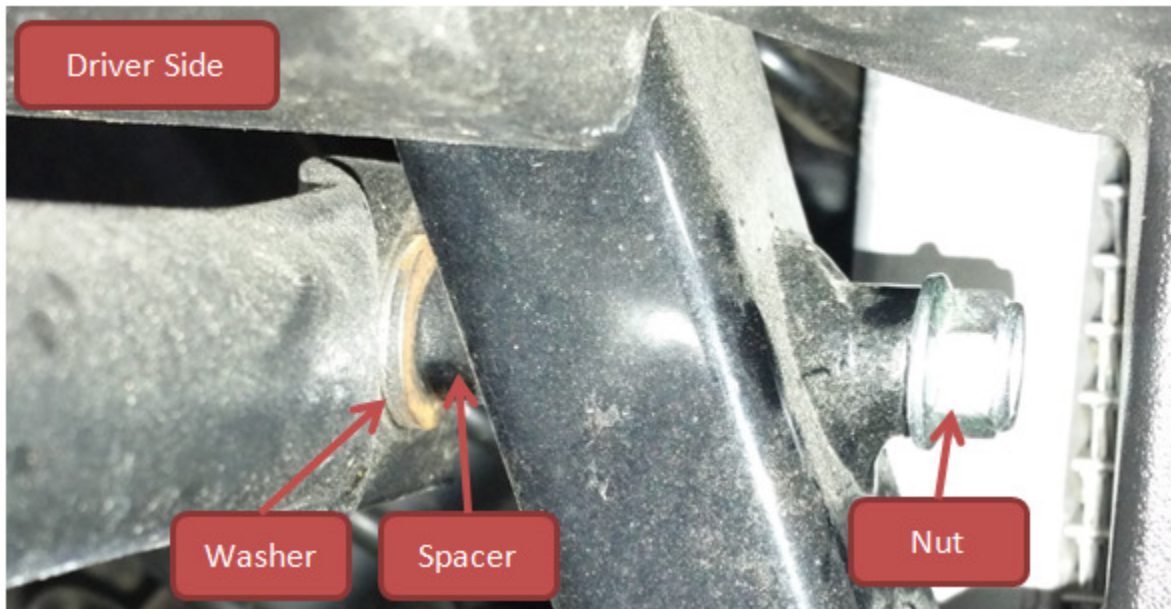

Figure 5

Winch Wiring - NOTE: When working with your vehicle's electrical system, always disconnect the negative battery terminal and secure the negative battery cable away from the battery.

6. Remove the plastic underbody panels to gain access to the frame for wiring routing as shown in Figure 6.



Figure 6

7. Remove the battery compartment cover found at the rear passenger side of the vehicle as shown in Figure 7.



Figure 7

8. Mount the winch contactor on the passenger side of the front relay/fuse panel as shown in Figure 8.

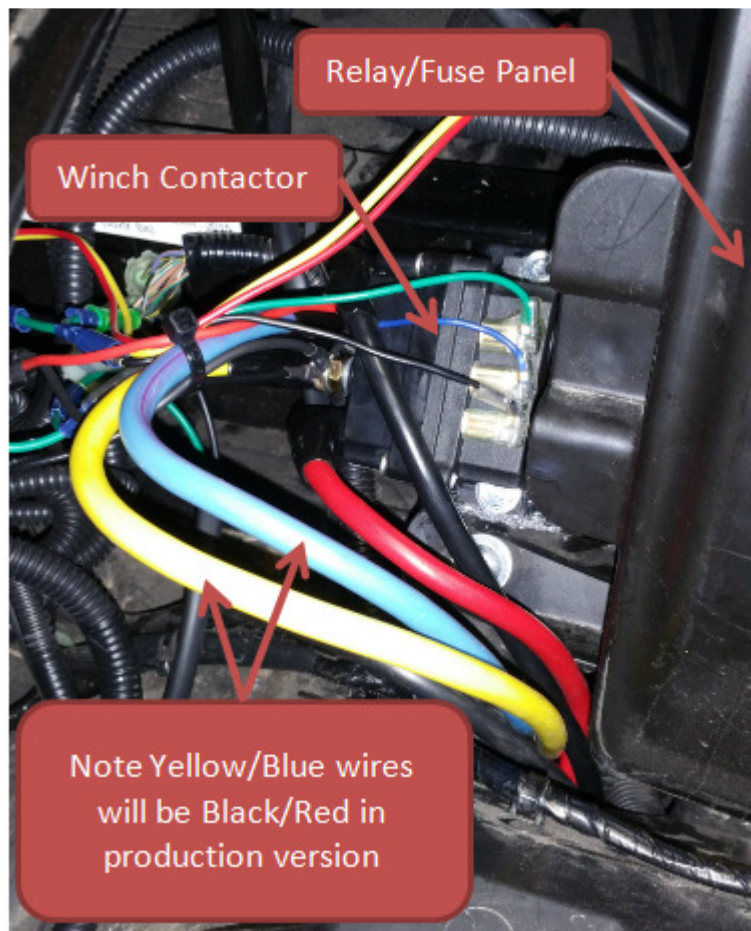

Figure 8

9. Because of the battery position in the Mule Pro FXT, an extended wiring kit is required. The extended wiring kit includes a set of 12 feet Black/Red cables. These will replace the Blue/Yellow cables included in the Viper winch kit. The color coding on the contactor and winch will be incorrect due to both sets of wires being Black/Red, take note of the wiring instructions below.

10. Connect the short pair of Red/Black power cables to the winch such that the Red wire is connected to the Blue winch terminal and the Black wire is connected to the Yellow winch terminal as shown in Figure 9.

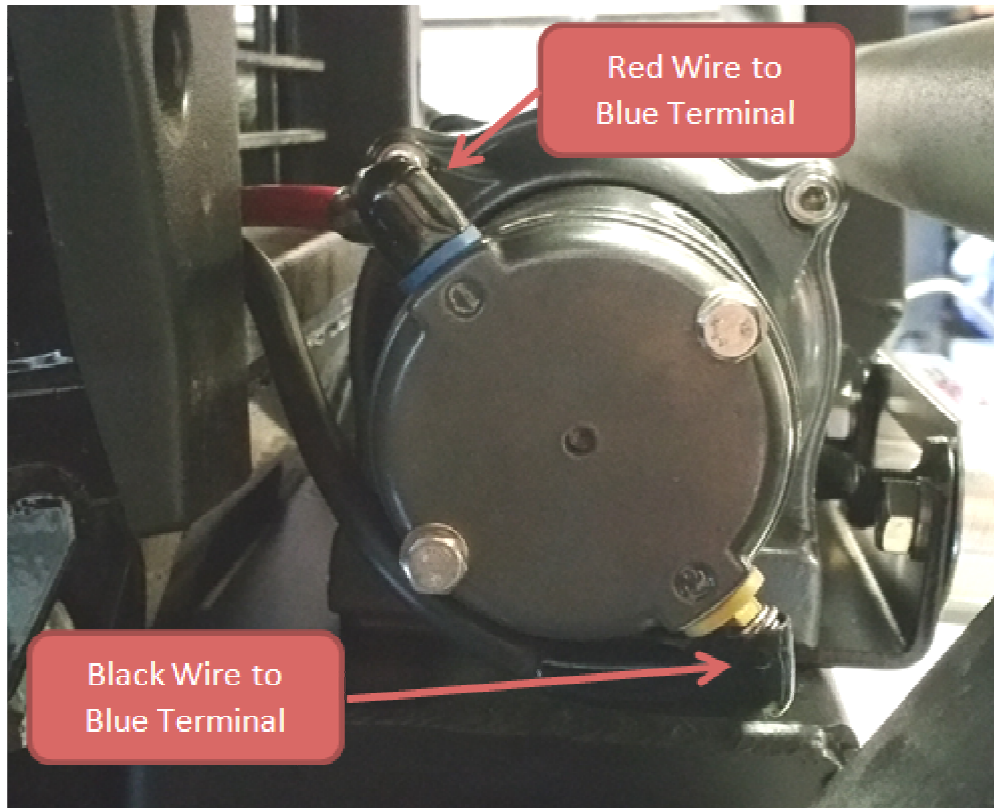

Figure 9

11. Attach the short Red/Black cables from the Winch to the Contactor so that the Red wire connects to the Blue Contactor terminal and the Black wire connects to the Yellow Contactor terminal.

12. Connect the long Red/Black wires to the Red/Black Contactor terminals according to their color. Route the long Red/Black cables toward the drive shaft tunnel by following the OEM wiring harnesses that exit the relay/fuse panel to the passenger side. Continue to follow the OEM wiring harnesses back to the battery and enter the battery compartment from the opening at the rear of the battery as shown in Figure 10.



Figure 10

13. Note that the wire colors shown in Figure 10 and 11 will not match the wire colors of the extended wiring kit. The wires will be Black and Red. Attach the Red Contactor wire to the positive battery terminal as shown in Figure 11. Lastly, use a socket and extension to loosen to the frame grounding bolt so that the Black Contactor wire can be attached as shown in Figure 11.

NOTE: The negative battery terminal is still disconnected at this point.



Figure 11



MotoAlliance
MA11939 Mule Pro FXT Winch Mount

14. Install the included winch switches to the contactor per the winch instruction manual.

15. Reconnect the negative battery terminal and test that the winch operates when using the switch. If the direction of the winch is reversed from the expected direction, swap the power cables that connect to the winch motor as this will reverse the polarity of the winch and thus the direction of travel.