



INSTALLATION INSTRUCTIONS

WINCH MOUNTING KIT

Part Number: 84706

Application: 2006+ Honda Rincon 680; 2003+ Honda Rincon;
2000+ Honda Rubicon

Your safety, and the safety of others, is very important. To help you make informed decisions about safety, we have provided installation and operating instructions and other information on labels and in this guide. This information alerts you to potential hazards that could hurt you or others. It is not possible to warn you about all potential hazards associated with this product, you must use your own good judgment.

CARELESS INSTALLATION AND OPERATION CAN RESULT IN SERIOUS INJURY OR EQUIPMENT DAMAGE. READ AND UNDERSTAND ALL SAFETY PRECAUTIONS AND OPERATING INSTRUCTIONS BEFORE INSTALLING AND OPERATING THIS PRODUCT.

This guide identifies potential hazards and has important safety messages that help you and others avoid personal injury or death. **WARNING** and **CAUTION** are signal words that identify the level of hazard. These signal words mean:

WARNING signals a hazard that *could* cause serious injury or death, if you do not follow recommendations. **CAUTION** signals a hazard that *may* cause minor to moderate injury, if you do not follow recommendations.

This guide uses **NOTICE** to call attention to important mechanical information, and **Note**: to emphasize general information worthy of special attention.

WARNING

INJURY HAZARD

Failure to observe these instructions could lead to severe injury or death.

- Always** use extreme caution when drilling on any vehicle. Make sure that all fuel lines, brake lines, electrical wires, and other objects are not punctured or damaged when / if drilling on the vehicle. Thoroughly inspect the area to be drilled (on both sides of material) prior to drilling, and relocate any objects that may be damaged. Failure to inspect the area to be drilled may result in vehicle damage, electrical shock, fire or personal injury.
- Always** wear safety glasses when installing this kit. A drilling operation will cause flying metal chips. Flying chips can cause eye injury.
- Always** use extreme caution when cutting and trimming during fitting.
- Always** remove jewelry and wear eye protection.
- Never** lean over battery while making connections.
- Never route electrical cables:**
 - Across any sharp edges.
 - Through or near moving parts.
 - Near parts that become hot.
- Always** insulate and protect all exposed wiring and electrical terminals.
- Always** install terminal boots as directed in installation instructions.
- Always** use appropriate and adequate care in lifting components into place.
- Always** insure components will remain secure during installation and operation.
- Always** tighten all nuts and bolts securely, per the installation and operation.
- Always** perform regular inspections and maintenance on the winch, winch mount and related hardware.
- Never** operate this **WARN** product with damaged or missing parts.

⚠ Caution
Moving Parts Entanglement Hazard
Failure to observe these instructions could lead to minor or moderate injury.
<input type="checkbox"/> Always take time to fully read and understand the installation and Operations Guide included with this product. <input type="checkbox"/> Never operate this product if you are under 16 years of age. <input type="checkbox"/> Never operate this product when under the influence of drugs, alcohol or medications.
Read installation and operating instructions thoroughly.

Notice
Equipment Damage
<input type="checkbox"/> Always refer to the Installation and Specification Guide, supplied in the winch kit, for all wiring schematics and specific details on how to wire this WARN product to your vehicle.
Read installation and operating instructions thoroughly.

Before You Begin

This kit is compatible with WARN's line of ATV winches. Winch sold separately. Please read WARN's Winching Technique guide provided with the winch prior to use of this product.

This kit is also compatible with the WARN Honda Rubicon Bumper kit (62331).

Table of Contents

I.	Parts List.....	2
II.	Tools Required.....	2
III.	Rincon Installation	3
IV.	Rubicon Installation	5
V.	Maintenance/Care	10

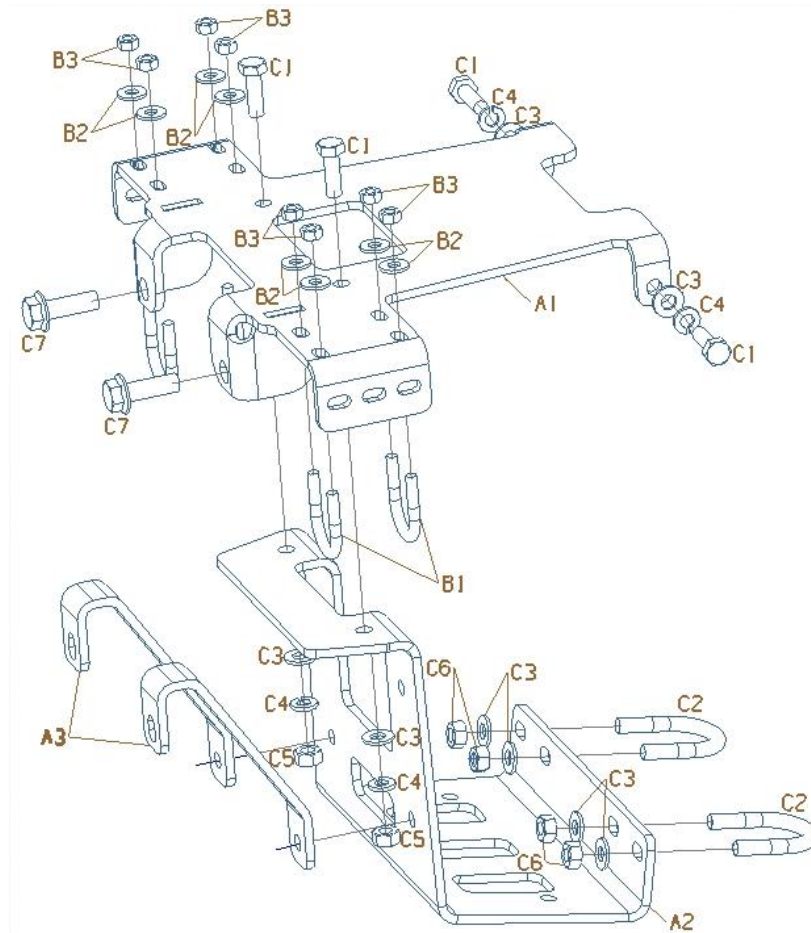

I. Parts List

<u>Ref</u>	<u>Part #</u>	<u>Description</u>	<u>Qty</u>
A1	82884	Upper Mounting Bracket	1
A2	61255	Lower Mounting Bracket	1
A3	82885	Angle Brace Bracket	1
B1	62066	6mm dia x 24mm wide U-bolt	4
B2	1320	1/4" dia flat washer	8
B3	60595	6mm dia nylock nut	8
C1	22508	8mm dia x 25mm long bolt	4
C2	60870	5/16" dia x 1-1/4" wide U-bolt	2
C3	1324	5/16" dia flat washer	8
C4	1402	5/16" dia lock washer	4
C5	13455	8mm dia regular nut	2
C6	2002	5/16" dia nylock nut	4
C7	79583	10mm dia. x 30mm long bolt	2

II. Tools Required

- Ratchet
- Sockets: 10mm, 12mm, 13mm, 1/2"
- Wrenches: 13mm
- Allen Wrenches: 5mm
- Shears or a similar cutting device

III. Rincon Installation

1. Begin by removing the front fascia and front skid plate on the vehicle as shown in figure 1. Save the fasteners as they will be used later in the installation.
2. Remove the 8mm bolts on both sides located just inside the front tires and on the ends of two horizontal tubes on the front tube frame as shown in figure 2.

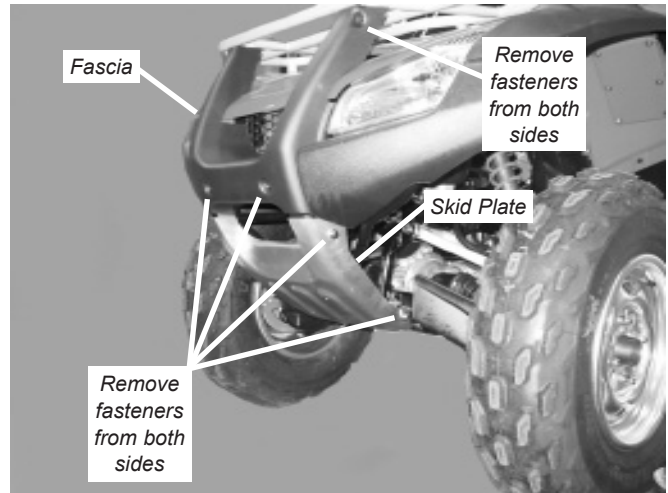

Figure 1 Remove Front Fascia and Skid Plate

3. Place the lower mounting bracket (A2) inside the front tube frame with the slotted holes facing down and the shorter back flange facing the rear of the vehicle as shown in figure 3.
4. Place the upper mounting bracket (A1) over the two horizontal tubes of the front tube frame with the two rear flanges covering the openings to the 8mm bolts removed in step 2. Attach the upper mounting bracket to the tube frame using two 8mm dia x 25 mm long bolts (C1), 5/16" dia lock washers (C4), and 5/16" dia flat washers (C3) as shown in figure 3. The lock washer should be placed between the head of the 8mm dia bolt and the flat washer. Tighten the bolt to a recommended torque of 14 ft-lb (19 N-m).

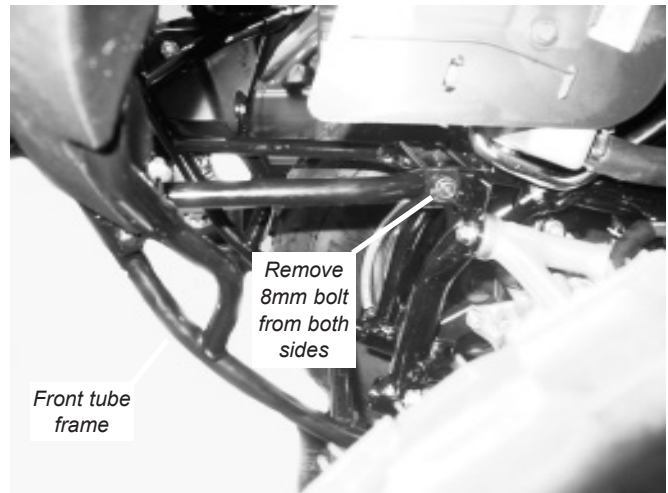

Figure 2 Remove 8mm bolt from both sides

5. Attach the lower mounting bracket (A2) to the upper mounting bracket (A1) using two 8mm dia x 25mm long bolts (C1), 5/16" dia flat washers (C3), 5/16" dia lock washers (C4), and 8mm dia regular nuts (C5) as shown in figure 3. The washers should go on the nut side, with the lock washer placed between the nut and flat washer. Tighten the nut and bolts to a recommended torque of 14 ft-lb (19 N-m).

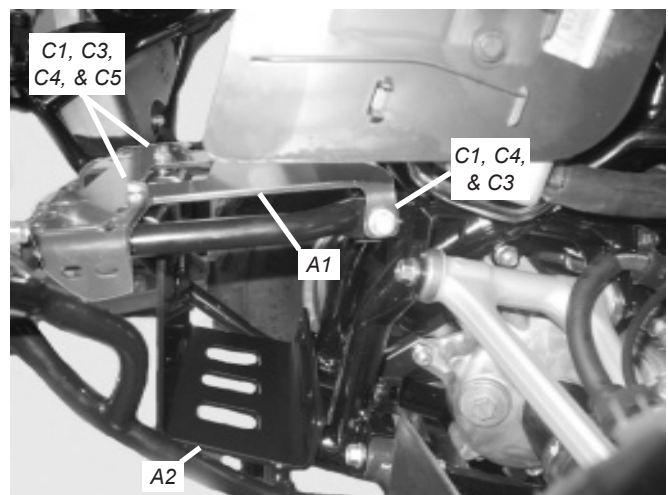

Figure 3 Install Upper and Lower Brackets

6. Attach the upper mounting bracket (A1) to the front tube frame using four 6mm dia x 24mm wide U-bolts (B1), and eight 1/4" dia flat washers (B2) and 6mm dia nylock nuts (B3) as shown in figure 4. Tighten the nuts to a recommended torque of 7 ft-lb (10 N-m).
7. Attach the lower mounting bracket (A2) to the front tube frame using two 5/16" dia x 1-1/4" wide U-bolts (C2), and four 5/16" dia flat washers (C3) and 5/16" dia nylock nuts (C6) as shown in figure 4. Tighten the nuts to a recommended torque of 14 ft-lb (19 N-m).

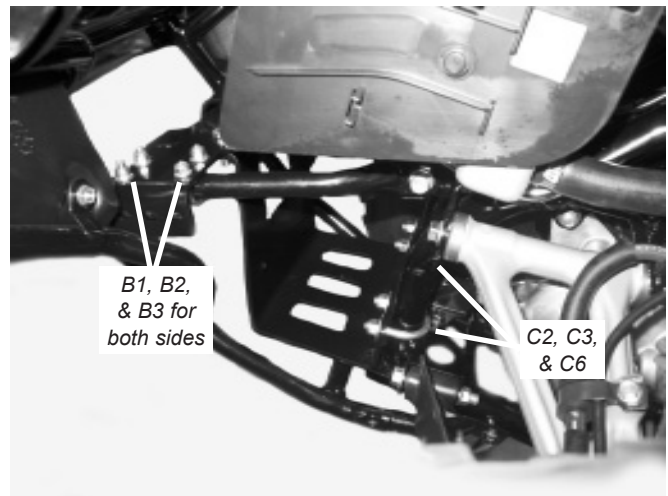

Figure 4 Attach U-bolts

⚠ WARNING
Tighten all nuts and bolts securely. Failure to check all nuts and bolts prior to use can result in product failure which can lead to vehicle damage and operator injury or death.

8. Double check that all nuts and bolt on the upper and lower mounting brackets are securely fastener. The assembled brackets should look like figure 5.

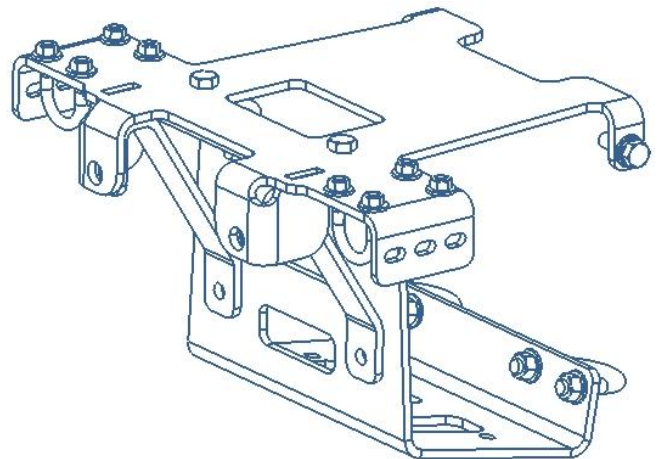

Figure 5 Assembled Upper and Lower Brackets

9. Using only the top two bolt holes, mount a WARN winch to the lower mounting bracket (A2) with 5/16" dia. bolts and lock washers supplied with the winch. Attach the angle brace brackets (A3) using the lower winch holes, M8 x 20MM and 25MM bolts and lock washers supplied with the winch. See figure 6. The feet of the winch are mounted forward with the motor facing the left side of the vehicle. Tighten the bolts to a recommended torque of 12 ft-lb (17 N-m).

NOTE: The longer 25MM bolt must be used in the bottom left winch hole (towards the motor).

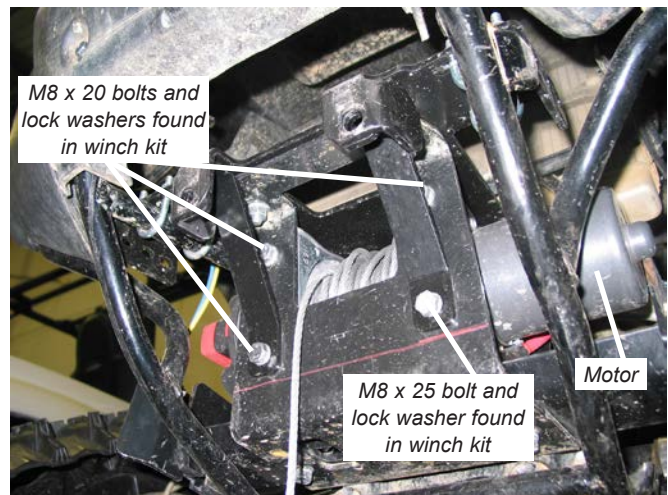

Figure 6 Attach Winch

10. Attach either the cast-iron hawse or roller fairlead (depending on your winch kit) to the upper mounting bracket (A1) using M10 x 30 bolts (C7) included, and nuts and washers provided with the winch as shown in figure 7. Hawse users will need to remove the hawse from the fairlead plate before mounting on the upper mounting bracket. Tighten all nuts and bolts securely.
11. Switch the winch clutch to freespool. Manually feed the winch cable through the hawse or roller fairlead. Attach the clevis hook, found with the winch, to the end cable loop. Reengage the winch clutch.
12. Reinstall the front fascia and skid plate using the hardware removed in step 1.
13. Complete the winch installation as described in the winch installation and specification guide that came with the winch.

Winch and winch mount installation is now complete and should look like figure 8. Proceed to section V, entitled "Maintenance/Care".



Figure 7 Attach Roller Fairlead



Figure 8 Completed Winch Installation on Rincon

IV. Rubicon Installation

1. Begin by removing the plastic fascia located on the front of the ATV. Remove the four fasteners located on the base of the fascia as shown in figure 9. Save these fasteners for later use in this installation. Remove the fascia from the ATV.

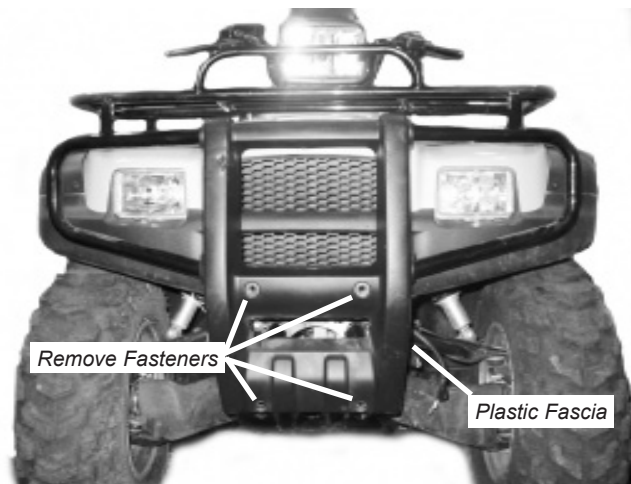

Figure 9 Remove Plastic Fascia

2. Remove the top four bolts (two on each side) fastening the front bumper to the ATV as shown in figure 10. Keep the fasteners for future use in this installation.



Figure 10 Remove top bolts from both sides

3. Remove the bottom four bolts (two on each side) fastening the front bumper to the ATV as shown in figure 11. Remove the front bumper from the ATV. Keep the fasteners for future use in this installation.

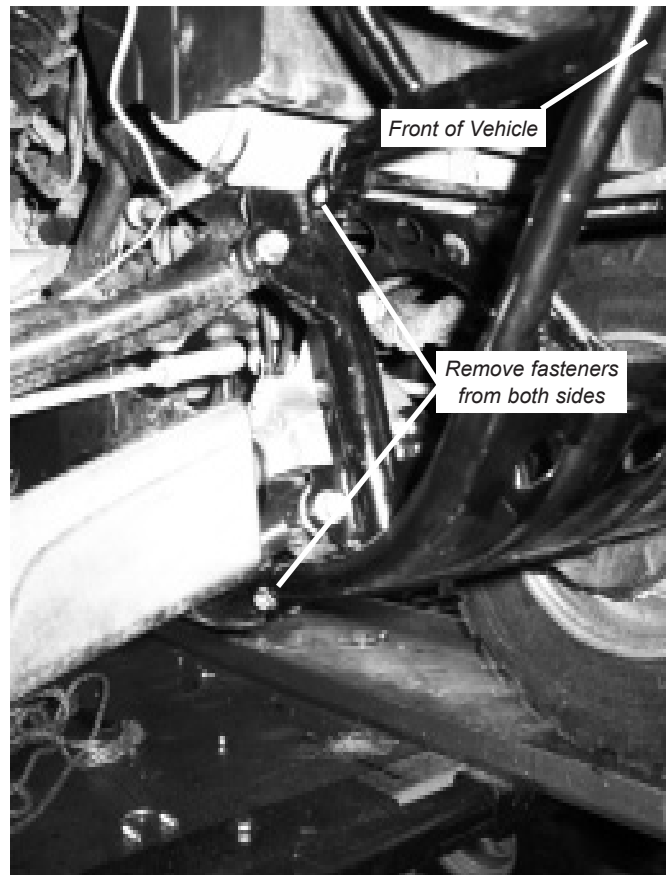

Figure 11 Remove Bottom Fasteners

4. Assemble the upper mounting bracket (A1) and the lower mounting bracket (A2) with two 8mm dia x 25 mm bolts (C1), 5/16" dia flat washers (C3), 5/16" dia lock washers (C4), and 8mm dia regular nut (C5) as shown in figure 12. The flat washer and lock washer should go on the nut side with the lock washer between the flat washer and regular nut. Do not tighten the nuts and bolts completely just yet. This will be done later in the installation.
5. Place the upper mounting bracket (A1) and lower mounting bracket (A2) inside the removed front bumper as shown in figure 13. Be sure the ends of the two horizontal tubes on the bumper are on the inside of the two rear flanges on the upper mounting bracket.
6. Reinstall the front bumper with the mounting brackets to the ATV using the fasteners removed in steps 2 and 3. Do not install the 8mm bolt that goes through the ends of the two horizontal tubes on the bumper.

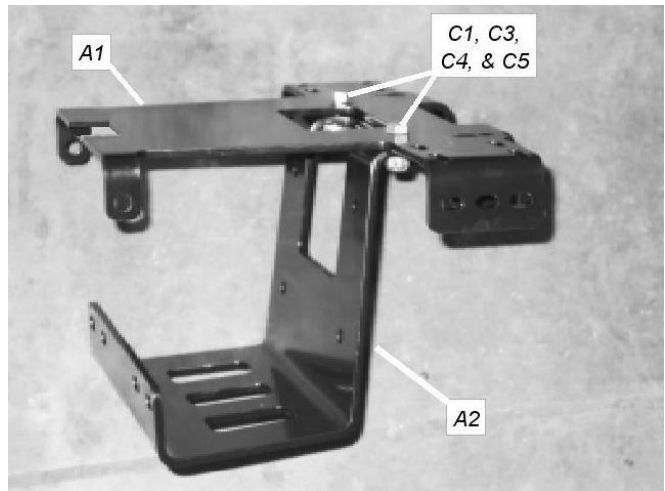

Figure 12 Assemble Upper and Lower Brackets

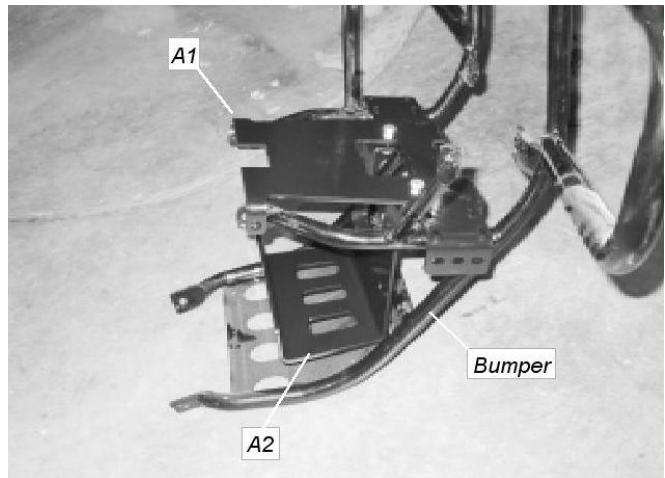

Figure 13 Place Upper and Lower Brackets inside Bumper

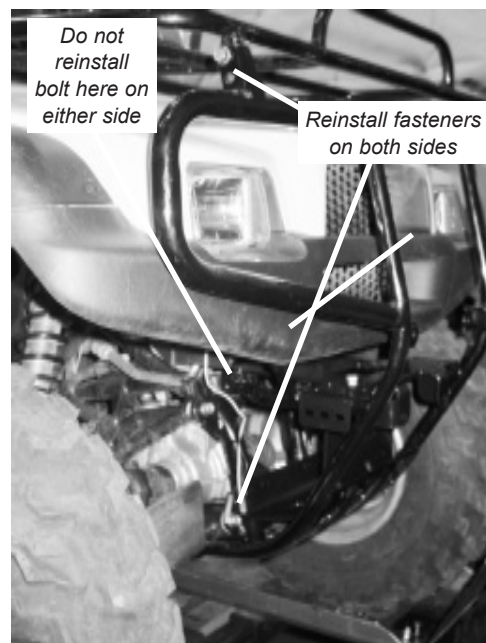

Figure 14 Reinstall Bumper

7. Install the rear of the upper mounting bracket (A1) to the front bumper using two 8mm dia x 25 mm long bolts (C1), 5/16" dia lock washers (C4), and 5/16" dia flat washers (C3) as shown in figure 15. The lock washer should be placed between the head of the bolt and flat washer. Tighten the bolts to a recommended torque of 14 ft-lb (19 N-m).
8. Install the front of the upper mounting bracket (A1) to the front bumper using four 6mm dia x 24 mm wide U-bolts (B1), and eight 1/4" dia flat washers (B2) and 6mm nylock nuts (B3) as shown in figure 15. Tighten the nuts to a recommended torque of 7 ft-lb (10 N-m).
9. Install the rear of the lower mounting bracket (A2) to the ATV frame using two 5/16" dia x 1-1/4" wide U-bolts (C2), and four 5/16" dia flat washers (C3) and 5/16" dia nylock nuts (C6) as shown in figure 15. Tighten the nuts to a recommended torque of 14 ft-lb (19 N-m).
10. Now tighten the two 8mm dia x 25mm long bolts (C1) and 8mm dia regular nuts (C5), shown in figure 12, to a recommended torque of 14 ft-lb (19 N-m).
11. Double check that all nuts and bolt on the upper and lower mounting brackets are securely fastener. The assembled brackets should look like figure 16.

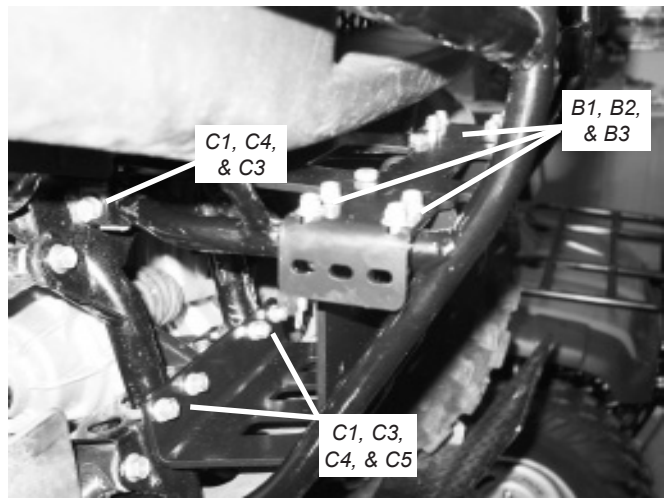

Figure 15 Attach Upper and Lower Brackets to Bumper

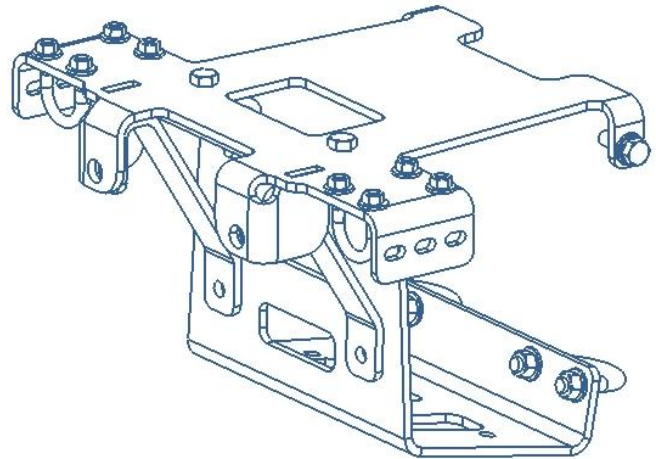



Figure 16 Assembled Upper and Lower Brackets

 WARNING
<p>Tighten all nuts and bolts securely. Failure to check all nuts and bolts prior to use can result in product failure which can lead to vehicle damage and operator injury or death.</p>

12. Using only the top two bolt holes, mount a WARN winch to the lower mounting bracket (A2) with 5/16" dia. bolts and lock washers supplied with the winch. Attach the angle brace brackets (A3) using the lower winch holes, M8 x 20MM and 25MM bolts and lock washers supplied with the winch. See figure 17. The feet of the winch are mounted forward with the motor facing the left side of the vehicle. Tighten the bolts to a recommended torque of 12 ft-lb (17 N-m).

NOTE: The longer 25MM bolt must be used in the bottom left winch hole (towards the motor).

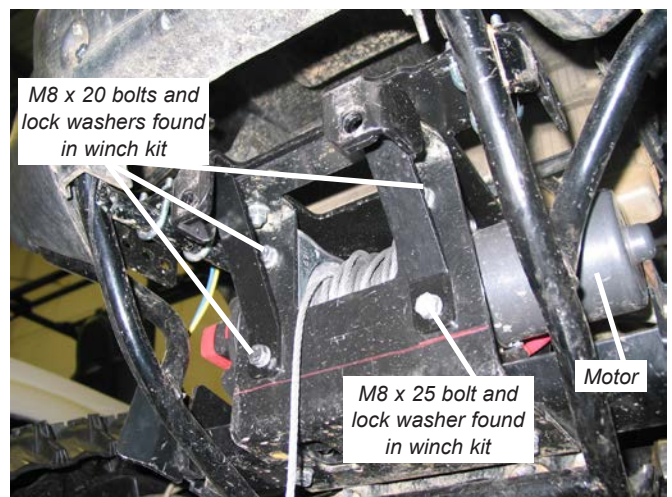

Figure 17 Install Winch

13. If the plastic fascia is to be reinstalled, material must be removed from the bottom opening. Place the plastic fascia face down in the ground. Remove material from the top corners of the bottom opening as shown in figure 18. Also, remove material from the bottom edge of the bottom opening. This will prevent the winch cable from rubbing against it. If during the next steps you find there is interference between the upper mounting bracket (A1) or the winch cable, remove the fascia and remove more material as needed.
14. If no more interferences exist between the upper mounting bracket (A1) and front fascia, reinstall the fascia with the fasteners removed in step 1 as shown in figure 19.
15. Attach either the cast-iron hawse or roller fairlead (depending on your winch kit) to the upper mounting bracket (A1) using M10 x 30 bolts (C7) included, and nuts and washers provided with the winch as shown in figure 19. Hawse users will need to remove the hawse from the fairlead plate before mounting on the upper mounting bracket. Tighten all nuts and bolts securely.
16. Switch the winch clutch to freespool. Manually feed the winch cable through the hawse or roller fairlead. Attach the clevis hook, found with the winch, to the end cable loop as shown in figure 19. Reengage the winch clutch. If you notice that the winch cable can rub against the front plastic fascia during winch operation, jump back to step 13 and remove more plastic material.

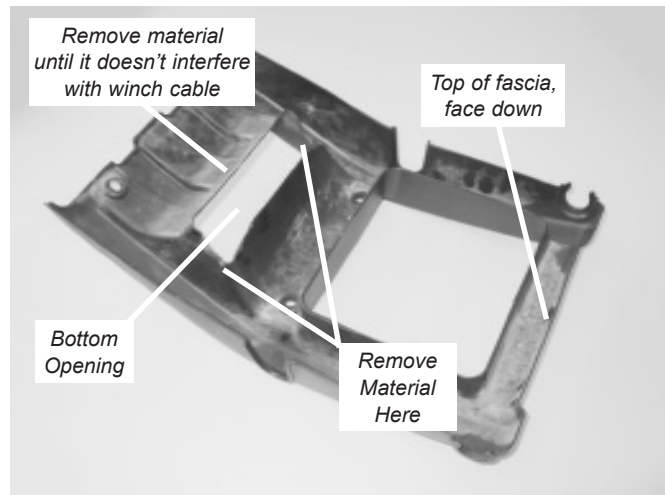

Figure 18 Cut Edges of Plastic Fascia

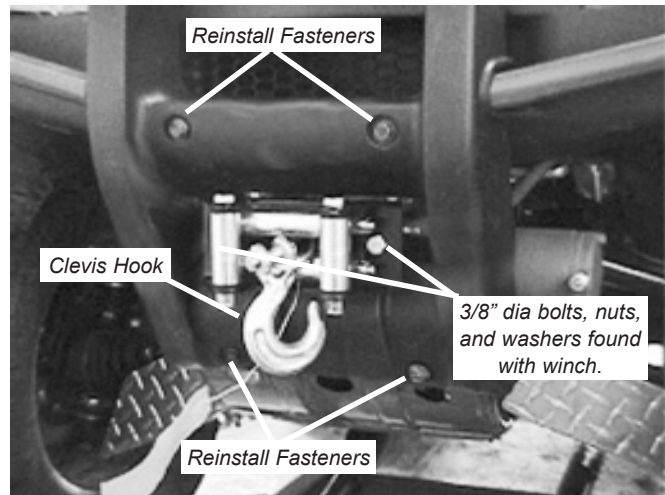

Figure 19 Completed Winch Installation on Rubicon

⚠ WARNING

Failure to remove interference between the winch cable and plastic fascia will lead to rapid cable wear and may cause the winch cable to break unexpectedly causing operator injury or death. Remove material from the front fascia until there are no interferences between the winch cable and fascia.

17. Complete the winch installation as described in the winch installation and specification guide that came with the winch.

Winch and winch mount installation is now complete and should look like figure 19. Proceed to section V, entitled "Maintenance/Care".

V. Maintenance/Care

- Inspect all metal parts on the winch, winch mount, and related hardware. Replace all that appears rusted or deformed prior to use.
- Inspect all nuts and bolts on the winch, winch mount, and related hardware prior to each use. Tighten all nuts and bolts that appear to be loose. Stripped, fractured, or bent bolts or nuts need to be replaced immediately.
- Check all cables prior to use. Replace cables that are worn or frayed.
- Check all moving and rotating parts. Remove debris that may inhibit the part from moving freely.

WARNING

Failure to perform regular inspections and maintenance on the winch, winch mount, and related hardware may result in vehicle damage and operator injury or death.