



# IMPORTANT INSTALLATION INSTRUCTIONS

Part# INST-WDYS-RUNNER-2

## Runner Installation Instructions

**ATTENTION, BEFORE INSTALLING RUNNERS IN YOUR SNOWMOBILE READ AND UNDERSTAND THE INFORMATION BELOW AND THE IMPORTANT SAFETY INFORMATION TO THE RIGHT:**

- Review the snowmobile manufacturer's owner's manual and/or aftermarket ski manufacturer's instructions to install runners. You may void your warranty if their recommendations are not followed.

Woody's manufactures a full line of quality runners for aftermarket ski's and for your specific sled model according to the ski specifications published by the original equipment manufacturers. Balancing the number of studs installed in the track with the amount of turning carbide on the runner is important for safety. The quantity of studs installed, the stud pattern, and the stud con-figuration as well as the terrain and your riding style factor in determining which runner is best suited for you.

### ⚠ CARBIDE RUNNER WARNING

Verify that the front end of the runner always fits tightly into the ski opening or indentation designed to accept the front end of the runner. The front end of the runner may snag objects if not properly installed. Woody's single, Dooly™ and Slim Jim® Dooly™ runners will always have a 90° angle in the front. Single runners and the runner components of the Dooly will have a 30° angle cut at the rear of the runner. The 90° angle is installed in the front of the ski and the 30° cut is installed at the rear of the ski. Failing to follow the installation instructions may result in personal injury and snowmobile and/or property damage. Tech Tip : R3-07-0005

You may be required to modify or add to the existing holes in your ski to ensure proper fit. (figure 8) Check the fit and/or the contour of the carbide runner to determine if a modification is needed; although, these modifications are rarely needed. If a modification is in question please call Woody's technical support before modifying a ski.

\*Never replace the runners on only one ski. Always use the new lock nuts provided with a new runner.

**Tools Needed:**  
Ratchet Wrench, Torque Wrench  
5/16" threaded bolt = 1/2" Deep Well Socket  
3/8" threaded bolt = 9/16" Deep Well Socket  
8mm threaded bolt = 13mm Deep Well Socket

**Optional Tools:**  
Rubber Mallet, Socket Extension  
5/16" threaded bolt = 1/2" End Wrench  
3/8" threaded bolt = 9/16" End Wrench  
8mm threaded bolt = 13mm End Wrench

### Ski and Snowmobile Preparation

Refer to your owner's manual for ski removal instructions if removing your ski for modifications.

- Insert the front end of the runner into the runner opening or indentation provided in the ski. (figure 1) Swing the rear end of the runner to align the runner bolts with the bolt holes in the ski. Then insert the bolts through the ski. Some pressure may be required. (figure 2)
- Hand tighten the nuts on all bolts. (figure 3) Using a ratchet wrench, tighten nuts starting with the center bolt, keeping the degree of threading on all bolts approximately even as the runner tightens to the ski. (figures 4-6)
- IMPORTANT** - For proper installation, optimum wear and performance use a ratchet and/or torque wrench. (figure 6 & 7) Refer to your snowmobile manufacturer's owner's manual and/or aftermarket ski manufacturer's runner installation instructions. To attempt to tighten more than their specifications may cause the nut threads to strip and/or nut to burrow into the ski.
- After the initial installation and after each use, check to make sure that the front end of the runner fits tightly in the opening or indentation in the ski designed to accept the front end of the runner. The runner should fit snug with the contour of the ski. (figure 8)
- After each use, check the carbide runners for wear.**
- Check for any fractures or breakage of the carbide runner, breakage of the threaded bolts, breakage and/or stripping of the nuts. If any of these occur, replace your carbide runners on both skis immediately.

**Caution - Runners or studs may wear at different rates with either the control of the front or the back of the sled diminishing. This may create an imbalance between the studs and turning carbide resulting in unreliable steering control that may cause injury or property damage. Check the runners and studs after each use to determine the amount of wear.**

**LIMITED WARRANTY** - INTERNATIONAL ENGINEERING & MANUFACTURING, INC. WARRANTS each product manufactured by it to be free from defects in material and workmanship under use for the purpose for which it is intended. The Company shall not be liable for damage or delays caused by defective materials or workmanship; is limited to the repair or replacement at its factory of defective article or part thereof, which may be returned to the factory, transportation charges prepaid, within one (1) year after delivery to the original purchaser. Proof of purchase is also required. The Company shall be the sole judge of the existence of any defect in the article so returned. No claims for charges incurred in the removal, disassembly or reinstallation of such article shall be allowed. Product manufactured for consumer use on snowmobiles is designed for snow or ice only, use on any other surface voids warranty.

This Warranty shall not cover any article which has been misused or neglected or damaged by accident or any article which has been altered outside the Company's factory. The Company shall, in no event be liable for consequential damage or contingent liability arising out of any total or partial failure to function of any article manufactured by it or of any equipment on or in which it is used. Failure of a user to give notice to claim as to defect claimed under the provisions of this Warranty within 1 year after delivery to original user, such claim shall constitute a waiver by consumer of all claims with respect to goods and equipment.

The above warranty is in lieu of all other warranties, expressed or implied, including but not limited to the implied warranties of merchantability and fitness for a particular purpose. In no event will the company be liable for consequential damages whether or not it has notice of the possibility of any such damages.

Follow the Woody's Manufacturer Warranty Returns directions to return any product from International Engineering & Mfg., Inc. Woody's, Team Woody's, Flat-Top, Top-Stock, Extender Trail III, Trail Blazer IV, Executive, Ultra Series, ACE, Dooly and Slim Jim are trademarks and/or trade names of International Engineering and Manufacturing, Inc.



## IMPORTANT SAFETY INFORMATION READ BEFORE INSTALLING STUDS AND RUNNERS

Throughout these warnings, the term **Personal Injury** - includes but is not limited to bruises, contusions, lacerations, broken bones, infection, loss of sight or hearing, limb amputation, and death.

The term **Damage to Snowmobile and Personal Property** - includes but is not limited to damage to the tunnel, bulkhead, cooling system, suspension, skid frame, engine, idler wheels, and the track. Damage could also occur to nearby objects and structures such as vehicles and buildings.

Keep in mind that after the installation of Woody's traction and control products the performance of the snowmobile, as it relates to acceleration and steering, will be dramatically affected. Acceleration may cause the front of the snowmobile to lift rendering it impossible to steer until the skis firmly re-engage the terrain; also, if the directions concerning the number of studs relative to the proper size of turning carbide are not followed, installation of an excessive number of studs will cause the snowmobile to exceed the steering capabilities so that it will proceed straight when the operator intends a turn, a condition known as "understeer". On the other hand, if too few studs are used compared to the size of turning carbide, the opposite result may occur, and the rear of the snowmobile will swing toward the outside of the turn, a condition known as "oversteer".

**It is extremely important to follow the installation instructions included with International Engineering's products and to operate the snowmobile in a very careful and alert manner.**

Personal injury or property damage as described earlier may occur if the rear of the snowmobile is lifted above the surface. This is especially dangerous if the track is engaged, but even more dangerous if the engine is accelerated. In that circumstance the track is not under load, the RPM will be higher, and centrifugal force could cause breakage of the track, dislodged flying studs and track debris with resultant personal injury and property and snowmobile damage.

Personal injury or snowmobile and property damage could also occur if the snowmobile track, equipped with Woody's traction and control products, engages with stones, rocks, pieces of wood, clumps of ice, or other items that could become projectiles. Also, if for some reason, such as too few studs being installed, a stud becomes "snagged", a stud itself could break off and become a projectile. It is, therefore, important that people and property, such as vehicles, not be positioned behind the snowmobile. **ALWAYS ATTACH THE SNOW FLAP TO THE TUNNEL WITH CORD/STRAP ON STUDED SNOWMOBILES.** (Part# MUD-STRAP)

It is also important to keep clothing and body parts away from a moving snowmobile track equipped with Woody's traction and control products. The studs could snag clothing or body parts and if that happens, personal injury or property damage could occur.

If the installer uses square washers, support plates, or backer plates, these should be installed, and kept, parallel with the lugs and the side of the track. **Failing to do this can cause the square washers, support plates, or backer plates, to dig into and weaken or damage the track and cause track failure which could result in personal injury or snowmobile and property damage.**

Woody's recommends that snowmobiles equipped with Woody's traction and control products not be operated on hard surfaces such as asphalt and concrete. If it is unavoidable to cross such surfaces, cross only at a steady slow pace just above the speed necessary to engage the drive mechanism. **If this direction is not followed, the turning carbide can catch or adhere to such surfaces causing the snowmobile to stop and remain stopped with the risk that the snowmobile and its occupant(s) could be struck or injured by other vehicles, including snowmobiles, automobiles, and trucks traveling on hard surface roadways.**

To reduce the risk of personal injury or snowmobile and property damage, it is important that the owner/operator/installer does not "mix" the manufacturer(s) of lock nuts, T-nuts, support plates, or studs, or stud length styles, or turning carbides.

Also, it is extremely important to read all literature associated with Woody's traction and control products and follow carefully the directions relating to stud patterns, the number of studs, and the number of studs related to the turning carbides in order to reduce the risk of personal injury or snowmobile and property damage. It is also extremely important to properly maintain the snowmobile and the track and to replace the track at the first sign of a break, a crack, a cut, a hole, a tear, or the presence of dry rot.

**Do not install or replace Woody's traction and control products on tracks or snowmobiles that show any of these conditions.**

It is extremely important to review the recommendations and warnings of the snowmobile manufacturer. Failing to do so can result in personal injury and snowmobile and property damage.

For trail use, Woody's recommends no more than 3/8 inch stud protrusion beyond the outer edge of the lug surface. If greater protrusion is present, damage to the bulkhead, track, and other structural and mechanical components of the snowmobile can occur.

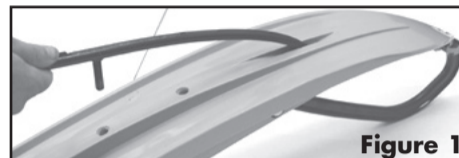

Figure 1

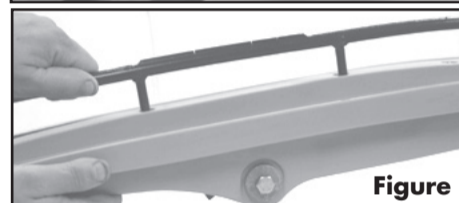

Figure 2

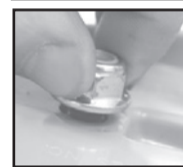

Figure 3

Figure 4

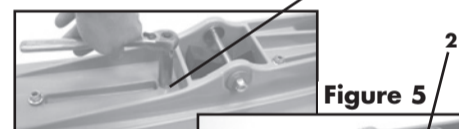

Figure 5



Figure 6



Figure 7



Figure 8

### SAFETY RECOMMENDATIONS

- \* Always attach the snow flap to the running board using Woody's® Snow Flap Strap Kit on studded snowmobiles.
- \* To avoid possible flying debris, never stand behind a rotating track.

### ⚠ WARNING

- NEVER STAND BEHIND or near a rotating track with/without a jack stand or back stand or kick stand.
- Do not lift rear of snowmobile track while operating.
- Track failure or debris can project with great force resulting in personal injury, dismemberment or death.



## Arctic Cat Ski Runner (2007-2018) Installation Instructions

To replace your stock runner, use Woody's® 9975 Dooly™, Slim Jim® or single runner. The 9975 series, which has 4 bolts, will fit your ski whether your ski has 3 or 4 bolt holes. If your ski has 4 bolt holes, install per the instructions with the runner. If your ski has 3 bolt holes, you will need to make a ski modification to accommodate an additional mounting bolt. These instructions are applicable if you are installing a Dooly™, Slim Jim® or a single runner from the 9975 series as the bolt pattern is the same.

If you choose to remove the ski to make this modification, refer to the instructions for ski removal in your snowmobile owner's manual.

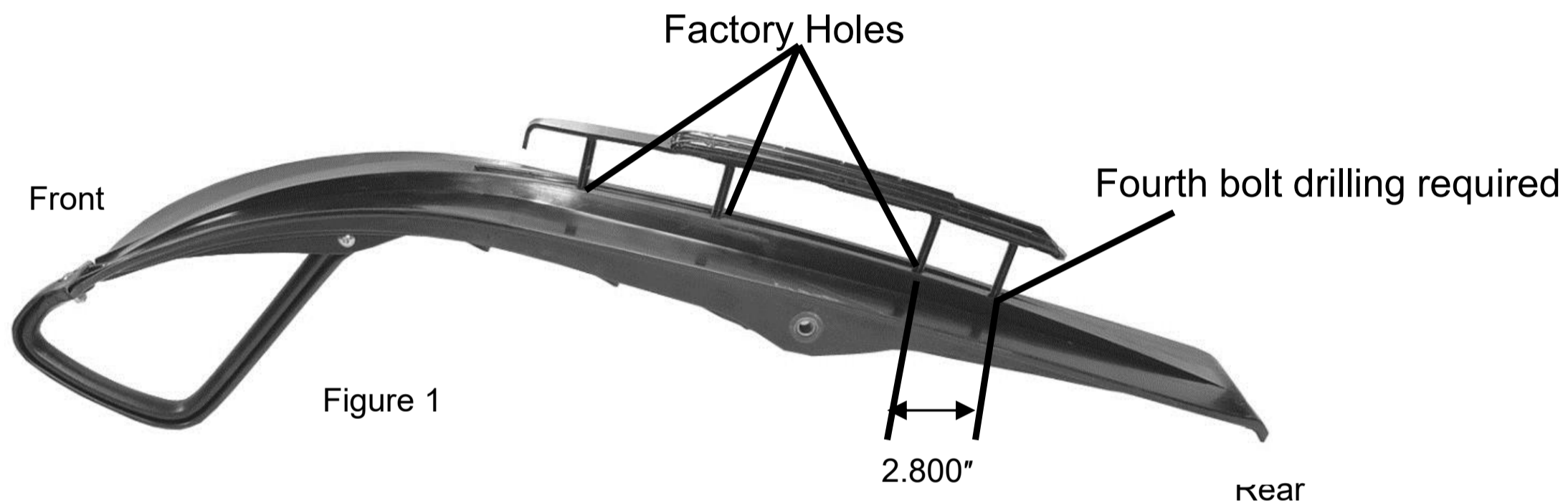

Figure 1

To install a Woody's 9975 series runner, which has a 4 bolt pattern, on a 3 bolt ski you will need to make the following modification to the ski. Please follow the important instructions below.

The ski modification you will need to make is an additional hole at the rear of the ski.

- 1) Place the 9975 series runner in the 3 bolt holes on the bottom of the ski. The fourth bolt will contact the ski at the point where the additional bolt hole will need to be drilled. (Figure 1) At this point using a marker place a mark on the keel at the center of the fourth bolt. (Figure 2) Or you can measure from the center of the bolt nearest the rear of the ski 2.800" to determine the new bolt hole placement. (Figure 3)
- 2) On the mark you have made to indicate the fourth hole placement, bore a hole through the ski using a 25/64"-drill bit. (Figure 4)
- 3) Install the Woody's® 9975 series runner by following the installation instructions provided in the package.

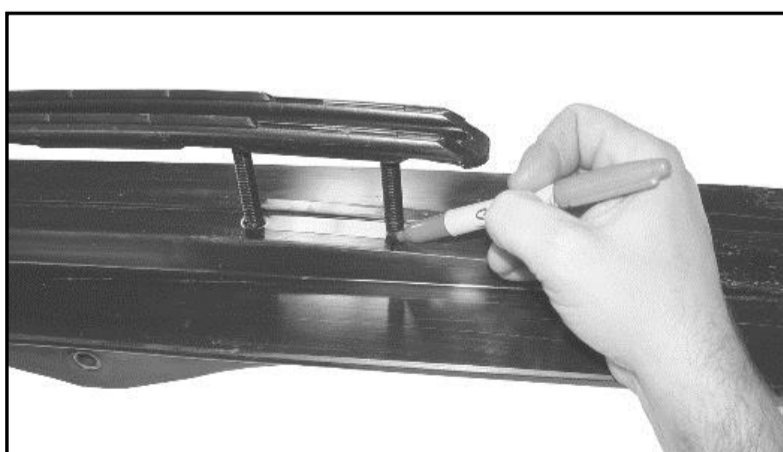

Figure 2

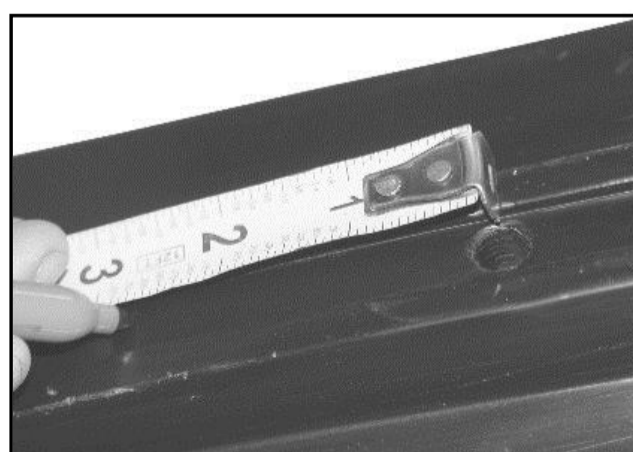

Figure 3

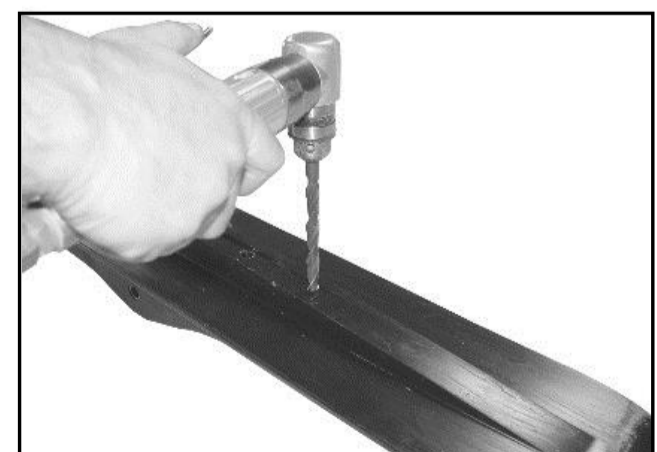

Figure 4

Review the snowmobile manufacturer's instructions to install runners in your owner's manual. You may void your warranty if their recommendations are not followed. Be certain to inspect the ski and/or runner for damage prior to installation. Failure to follow all of the above instructions will void any and all warranties of IEM.