

ITEM	PART NO.	DESCRIPTION	QTY.
1	12514310	Muffler	1
2	HS123	Heat Shield Backer	1
3	HS124	Heat Shield	1
	PK970	Hardware Pack includes:	1
4	HW276	M6 x 1.0 x 16mm BTNHD Screw	6

ITEM	PART NO.	DESCRIPTION	QTY.
5	HW338	M6 Flat Washer	10
6	HW337	M6 Split Lock Washer	4
7	HW127	M6 x 1.0 Hex Nut	4
8	HW538	0.335" Black Push-In Blind Rivet	4

## OVERVIEW:

### DISCLAIMER:

This exhaust system is intended for closed course competition use only, and is not legal for use on public highways or trail systems.

### REQUIRED MATERIALS

- Penetrating oil (WD-40 or similar)
- Anti-seize compound (Permatex Nickel or similar)

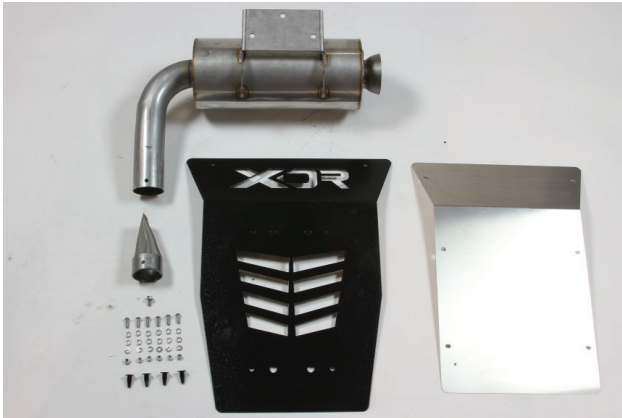

1. Take a moment to read and understand these instructions before installing your Competition Exhaust System.

### REMOVE FACTORY EXHAUST SYSTEM:

### WARNING:

Avoid serious burns! Allow vehicle time to cool completely before handling any of the stock engine components.

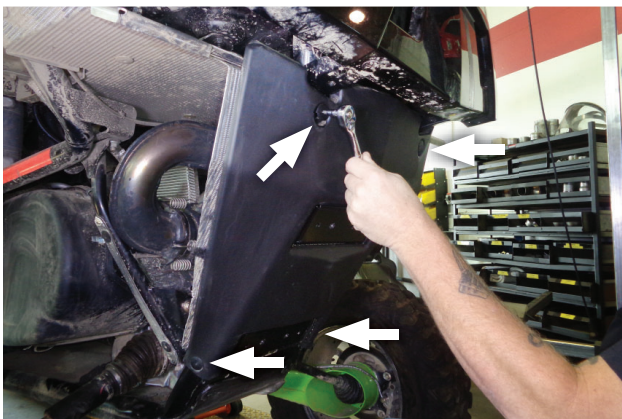

2. Remove factory screws (x4) and backing plate from vehicle.

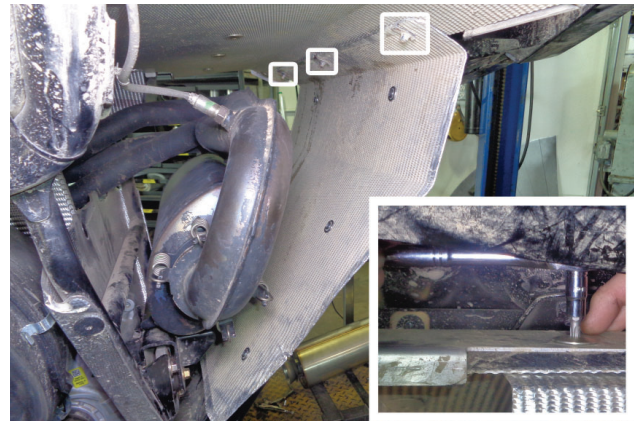

3. Remove factory screws (x3) securing top of heat shield from vehicle.

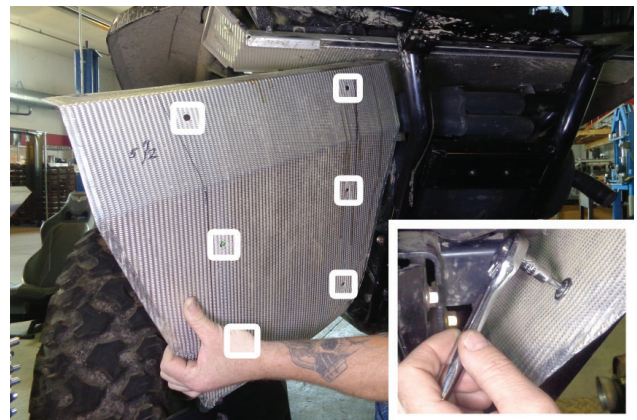

4. Remove remaining factory screws (x6) and heat shield from vehicle. Retain screws for later use.

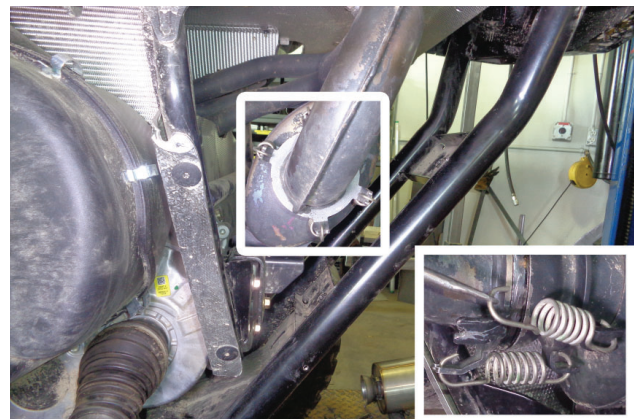

5. Use spring puller to release then remove muffer mount springs (x4) from muffer and exhaust. (Retain for later use.)

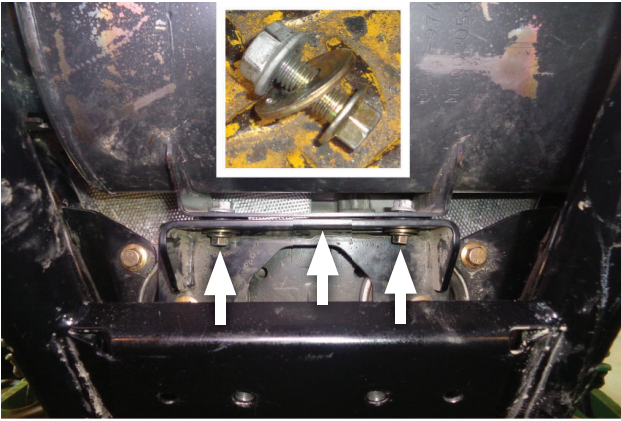

6. Disassemble bolt (x3), washers and nuts securing factory muffler to vehicle. (Retain for later use).

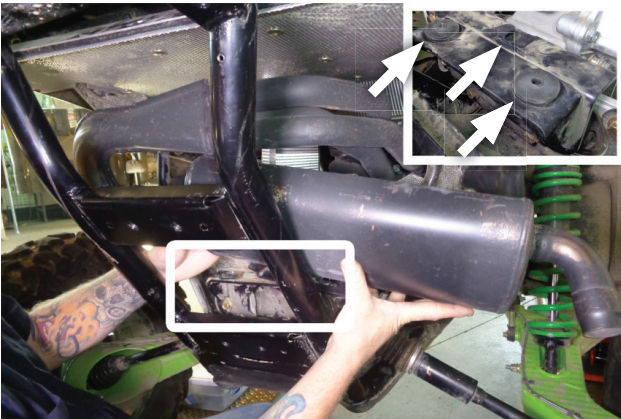

7. Remove factory muffler from exhaust. Transfer mount grommets (x3) from muffler back onto vehicle as shown.

**INSTALL YOUR XDR COMPETITION EXHAUST:**

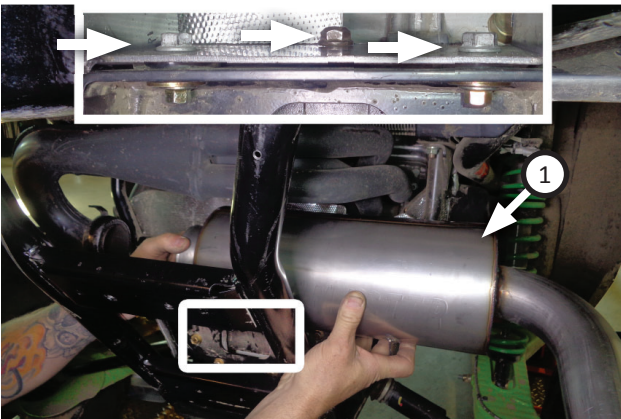

8. Connect **muffler (1)** to exhaust outlet then install bolts (x3), washers and nuts (removed step 6) to secure it.

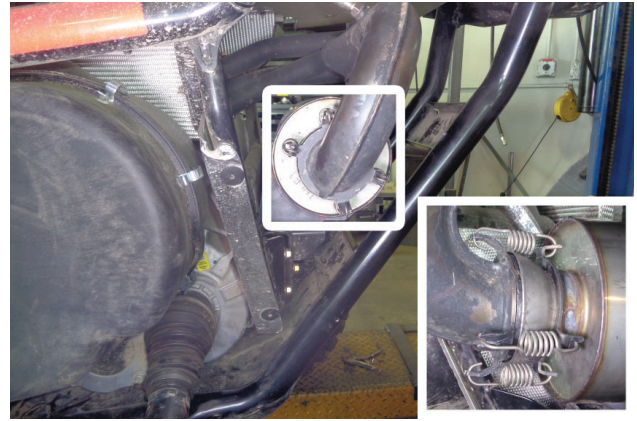

9. Install muffler mount springs (x4) to connect muffler and exhaust outlet. (removed step 5).

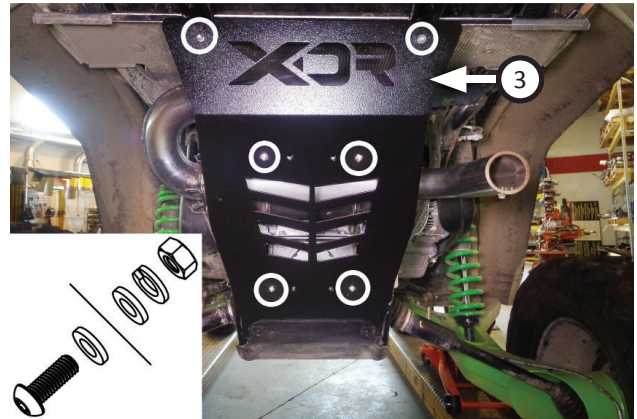

10. Install **heat shield (3)** over muffler using **screws (4)**, **flat washers (5)**, **split lock washers (6)** and **hex nuts (7)**. Tighten fastener assemblies completely.

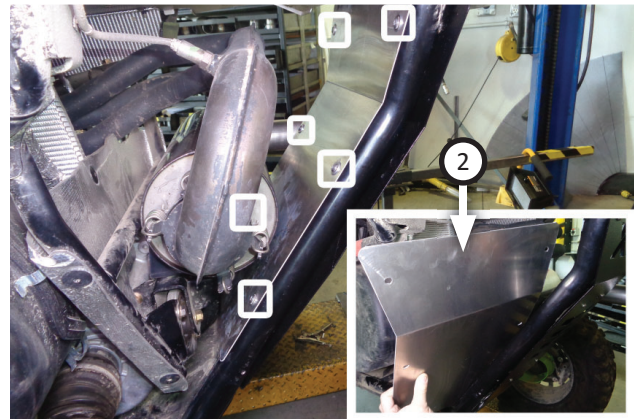

11. Install **heat shield backer (2)** using factory screws (x6) (removed step 4). Tighten them completely.

NOTES:

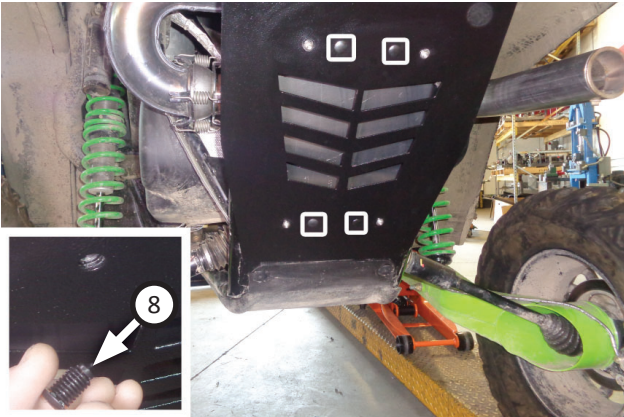

12. Install **0.335 black push-in blind rivets (8)** into heat shield.



Congratulations, the installation of your XDR Off-Road Competition exhaust is now complete!

