

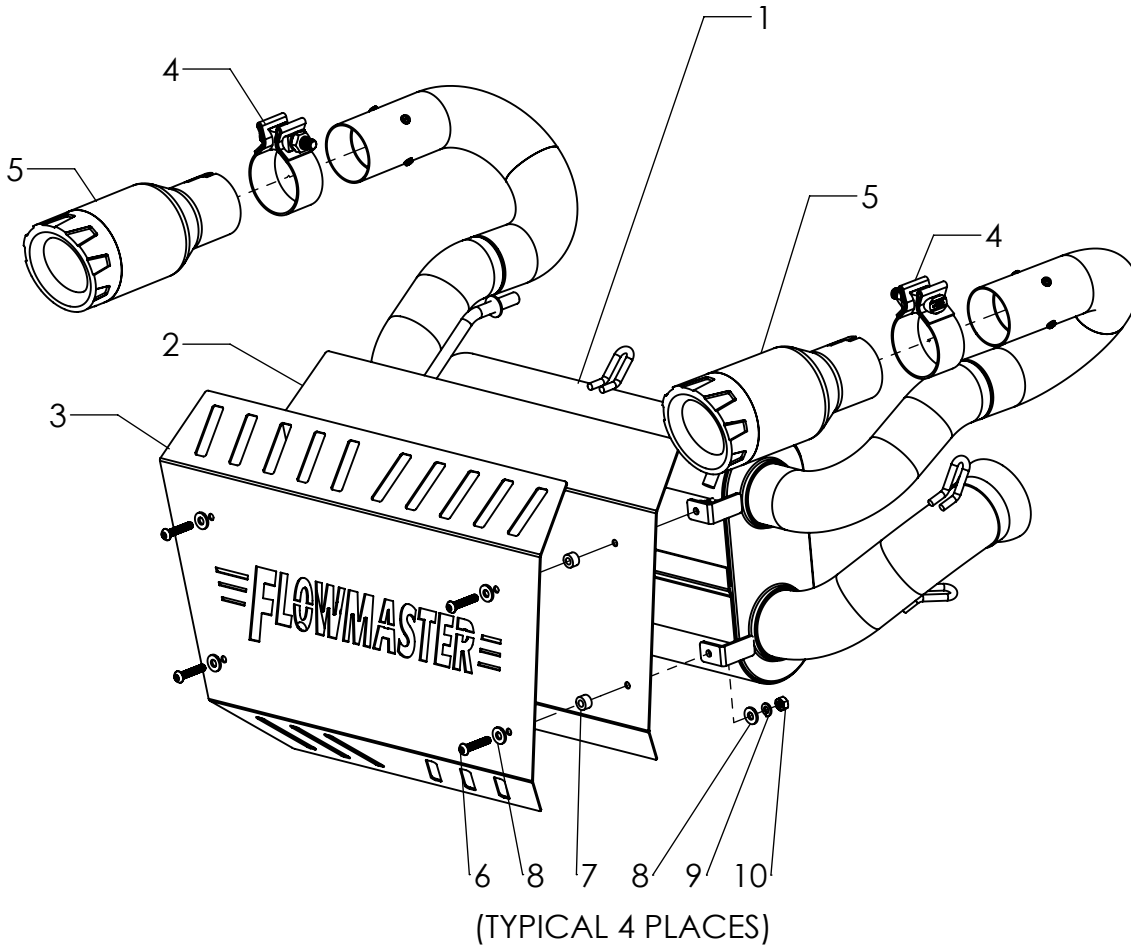

409S® Stainless Steel

Installation Instructions for:  
**SYSTEM #7512**  
**DUAL EXHAUST KIT**  
**2014 Polaris RZR 1000 UTV**



ITEM NO.	PART NUMBER	DESCRIPTION	QTY.
1	842583-455	MUFFLER, AXLE BACK, 2014 POLARIS RZR XP 1000	1
2	HS113	BACKER, HEATSHIELD , POLARIS RZR 1000	1
3	HS112	HEATSHIELD, POLARIS RZR 1000	1
4	MC225BS	CLAMP, 2.25" STAINLESS	2
5	ST473	EXHAUST TIP, BRUSHED BODY/ BLACK END 3-1/2" × 2-1/4"	2
6	HW251	SCREW, 1/4"-20 × 1-1/4"	4
7	HW520	SPACER, 1/2" O.D. × 1/4" I.D. × 5/16" L	4
8	HW333	FLAT WASHER, 1/4"	8
9	HW332	LOCK WASHER, 1/4"	4
10	HW124	NUT , 1/4"-20	4

**REVIEW THE INSTRUCTIONS AND VERIFY THE KIT CONTENTS:**

1. Please take a moment to read and understand these instructions before installing your Flowmaster exhaust kit.



2. Use the parts drawing and list (front page) to verify your kit's contents.

In the unlikely event that any parts are missing, please contact Flowmaster Technical Support for replacements.

**REMOVE THE FACTORY EXHAUST SYSTEM:**

**WARNING**

**Avoid serious burns! Allow the exhaust system to cool completely before removing the factory exhaust system.**

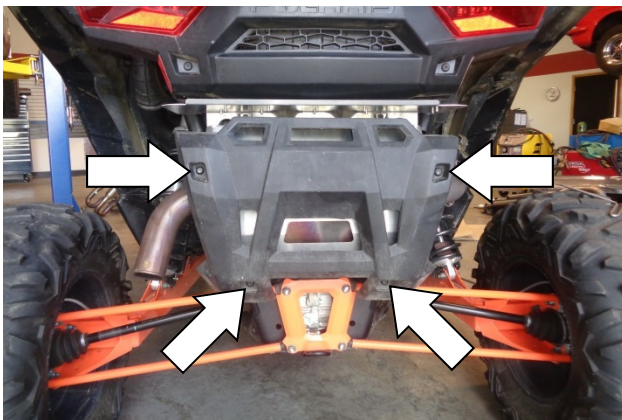

3. Remove the four heat shield bolts .

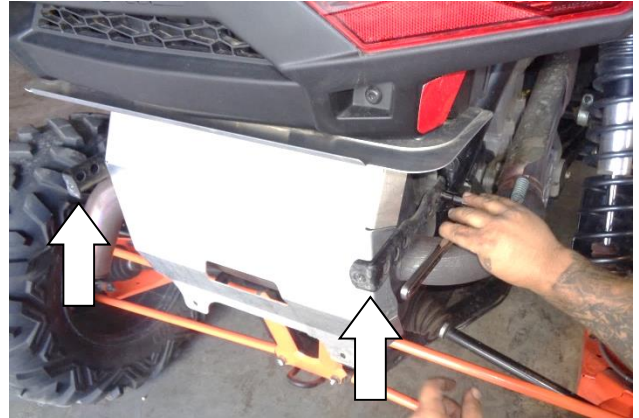

4. Remove the two upper heat shield brackets.

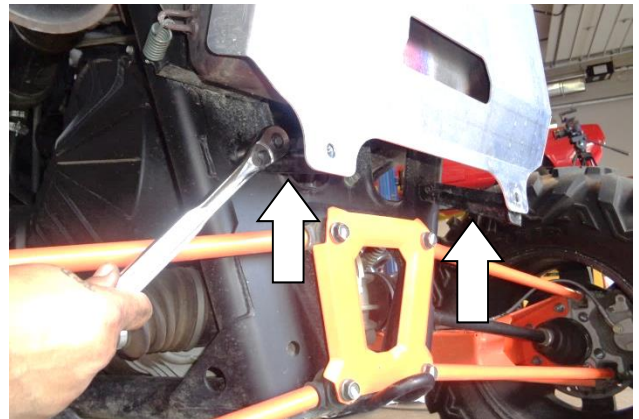

5. Remove the two lower heat shield brackets.

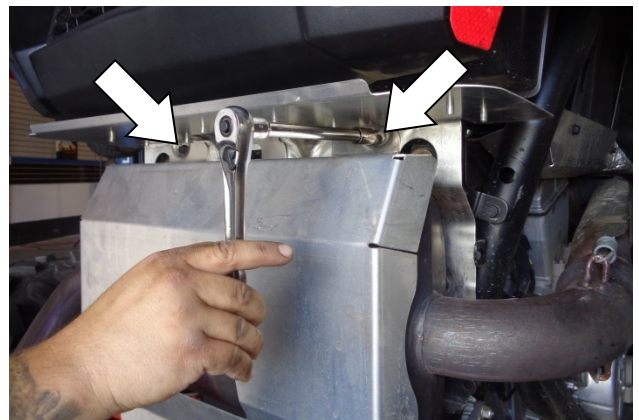

6. Remove the two heat shield backer bolts. Remove the heat shield backer. Then reinstall the two bolts.



7. Use a spring puller to release the four muffler mount springs.



8. Remove the muffler from the vehicle.



9. Inspect the lead gasket on the end of the exhaust pipe for serviceability. Replace if required.

## ASSEMBLE AND INSTALL YOUR FLOWMASTER EXHAUST SYSTEM:



10. Install the new muffler (item 1) by pushing the two hanger pins into the rubber mounts. Ensure proper alignment the exhaust pipe and muffler flange.

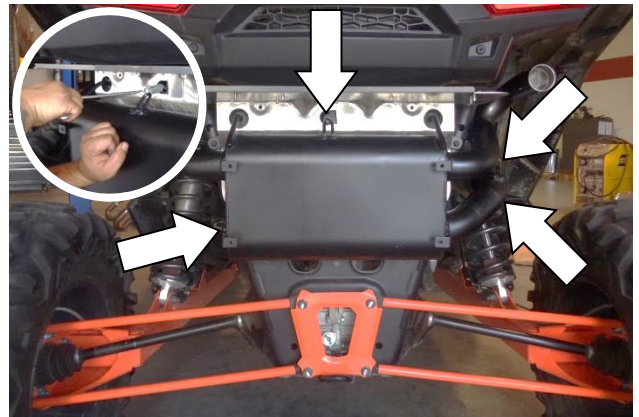

11. Use a spring puller to connect the four muffler mount springs to the new muffler.

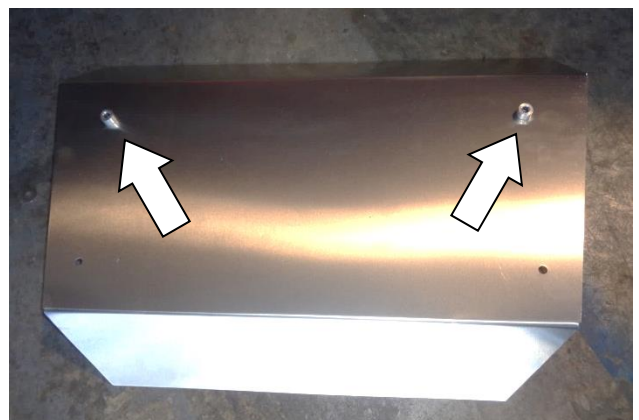

12. Place the heat shield backer (2) on a bench or other flat surface. Place spacers (7) over the top two holes.



13. Place the heat shield (3) over the spacers and place flat washers (8) over the top two holes. Align the backer, spacer and the shield holes, and insert screws (6) in them.



14. Grasp the aligned heat shield, backer and hardware and hang the assembly on the muffler's two top mount holes. Then install a flat washer (8) and lock washer (9), and hand-start a nut (10), on each screw.



15. At each bottom hole, hold a spacer (7) in between the heat shield and backer. Install a screw (6) with flat washer (8) through the stacked parts. Then install a flat washer (8), lock washer (9), and nut (10) on each screw.

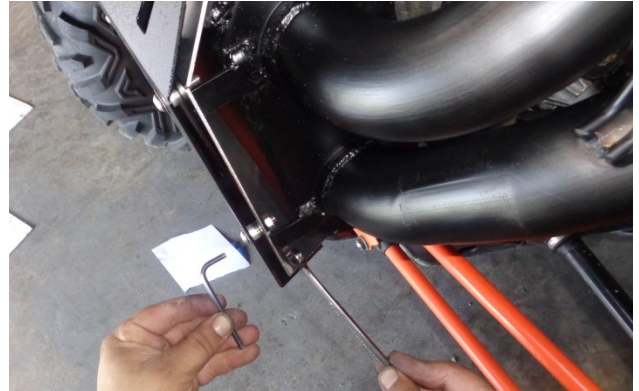

16. After the fasteners have been started at all four mount holes, tighten the fasteners.

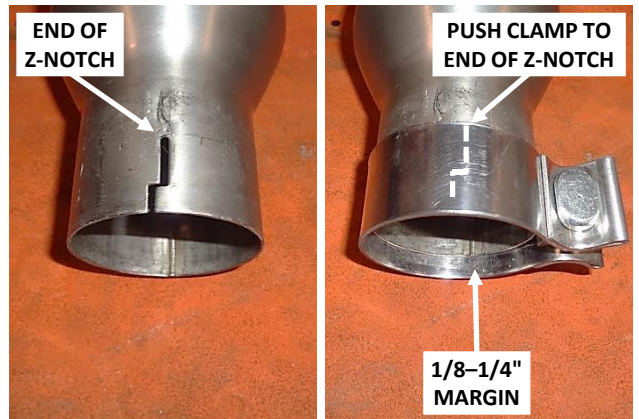

17. Install one clamp (4) on the opening of each exhaust tip (5). For best retention, push the clamp just to the end of the Z-notch, leaving 1/8" to 1/4" of the clamp extending past the tip opening.



18. Note also that each clamp bolt should be on the inboard side of the tip, with its nut pointing down. Install each tip on its exhaust pipe.

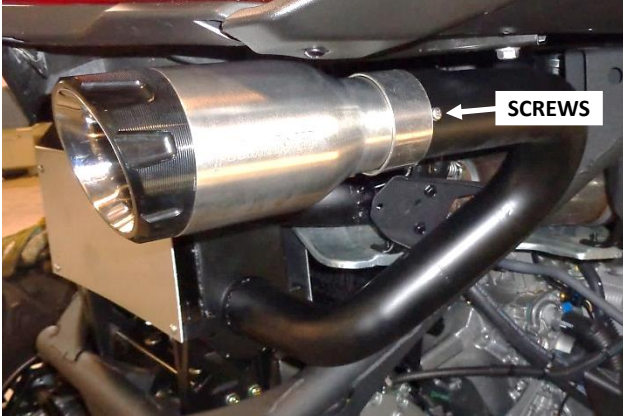

19. Push each tip onto its pipe until its clamp touches the spark arrestor screws. Also be sure to keep the rear edge of the clamp just over the end of the Z-notch (per Step 17). When each tip is in place, tighten the clamp.



**Congratulations, the installation of your FLOWMASTER exhaust kit is now complete!**

**IMPORTANT: RETAIN THESE INSTRUCTIONS FOR FUTURE REFERENCE**

Flowmaster maintains a highly-trained technical service department to answer your technical questions, provide additional product information and offer various recommendations.

Direct all correspond



# SPARK ARRESTOR MAINTENANCE FOR FLOWMASTER ATV & UTV EXHAUST SYSTEMS

Flowmaster ATV and UTV exhaust systems are equipped with US Forest Service-qualified spark arrestors, which are designed to prevent the discharge of sparks from the exhaust pipes.

Spark arrestors must be inspected and cleaned periodically to prevent clogging and deterioration, which can adversely affect the performance of both the spark arrestor and the engine.

## WARNING

**Avoid serious burns! Allow the exhaust system to cool completely before inspecting the spark arrestors.**



1. Loosen the exhaust pipe tip clamp and remove the tip.

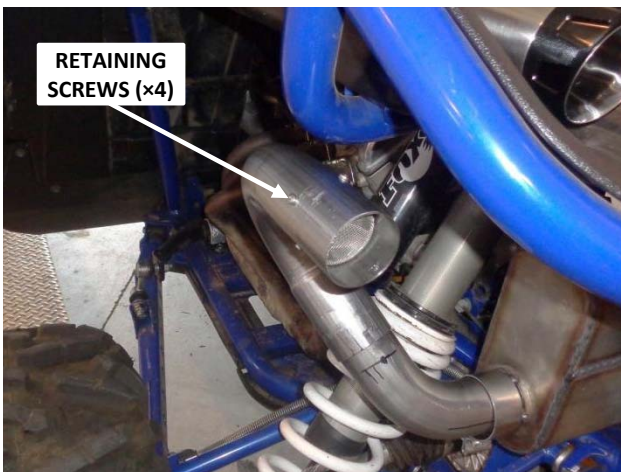

2. Remove the four retaining screws and washers.



3. Remove the spark arrestor screen.
4. Soak the screen in carburetor cleaner or oven cleaner to loosen carbon buildup.
5. Clean the screen using a wire brush.
6. Inspect the screen for wear or damage.

## WARNING

**Replace any spark arrestor whose screen is worn or damaged.**

7. Reinstall the spark arrestor screen and exhaust pipe tip. (Installation is the reverse of removal.)

## NOTE

**Do not operate the vehicle unless serviceable spark arrestors are installed.**