

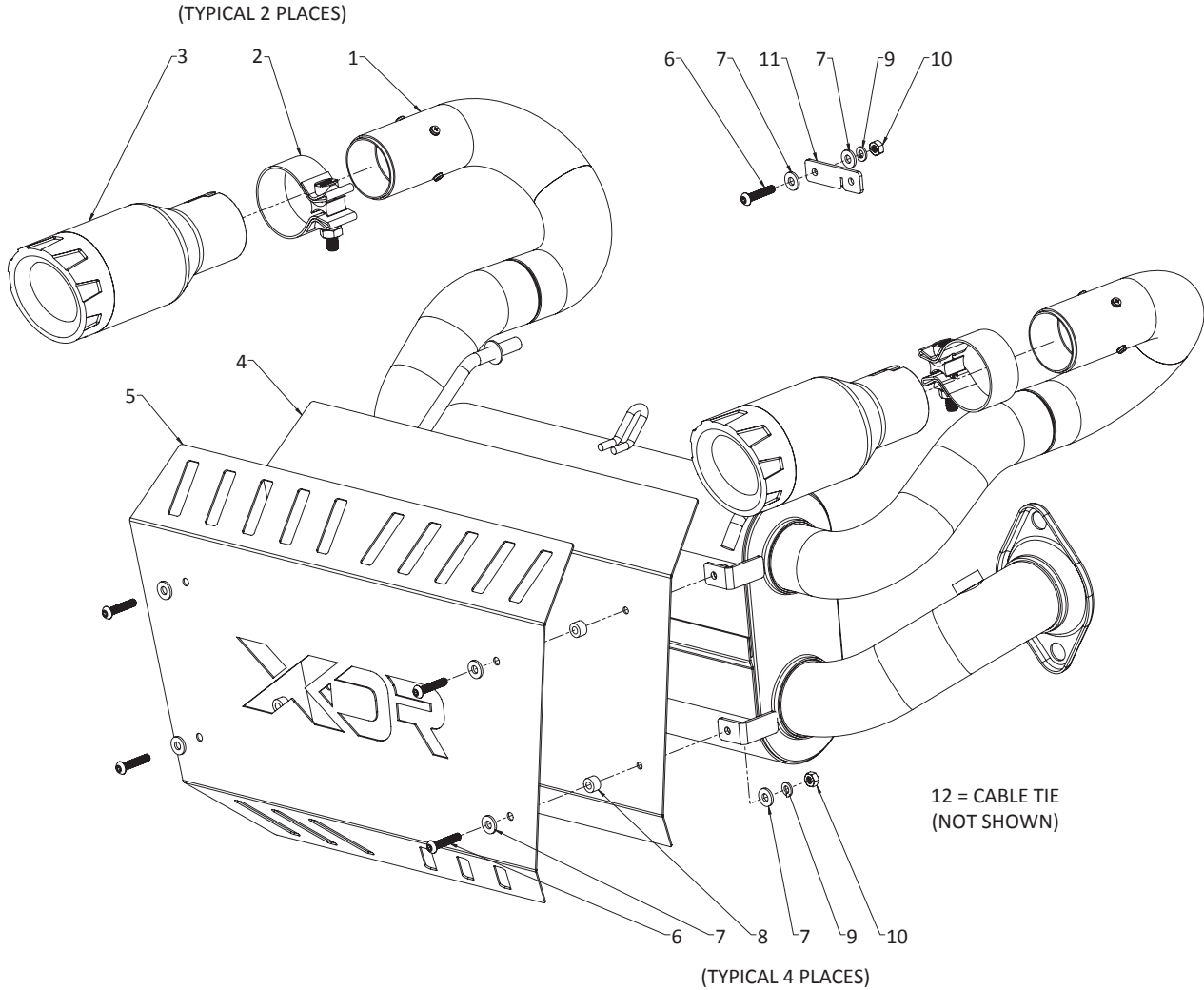

Installation Instructions for 7523 DUAL EXHAUST for 2018 POLARIS RZR XP 1000



ITEM NO.	PART NO.	DESCRIPTION	QTY.
1	842583-522	MUFFLER, 18 POLARIS RZR XP 1000, AXLE BACK	1
2	MC225BS	BAND CLAMP, 2.25" STAINLESS	2
3	ST473	TIP, BRUSHED BODY/ BLACK END, 3-1/2" x 2-1/4"	2
4	HS113	HEAT SHIELD BACKER, POLARIS RZR 1000	1
5	HS125	HEAT SHIELD, POLARIS RZR 1000, XDR LOGO	1
6	HW251	SCREW, 1/4"-20 x 1-1/4" BUTTONHEAD	5
7	HW333	FLAT WASHER, 1/4"	10
8	HW520	SPACER, 1/2" OD x 5/16" ID, ALUMINUM	4
9	HW332	LOCK WASHER, 1/4"	5
10	HW124	HEX NUT, 1/4"-20	5
11	HA1654	BRACKET, 15-17 RZR XP 1000, VENT TUBE	1
12	HW537	CABLE TIE, BLACK, 8.5"	1

REQUIRED MATERIALS

- Penetrating oil (WD-40 or similar)
- Anti-seize compound (Permatex Nickel or similar)

REVIEW THESE INSTRUCTIONS AND VERIFY THE KIT CONTENTS

1. Take a moment to read and understand these instructions before installing your XDR exhaust kit.



2. Use the parts drawing and list (front page) to verify your kit's contents.

REMOVE THE FACTORY EXHAUST SYSTEM

WARNING

Avoid serious burns! Allow the exhaust system to cool completely before starting removal.

NOTE: Retain all factory parts.



3. Remove the 4 heat shield bolts.



4. Note the location of the 2 upper and 2 lower heat shield brackets.

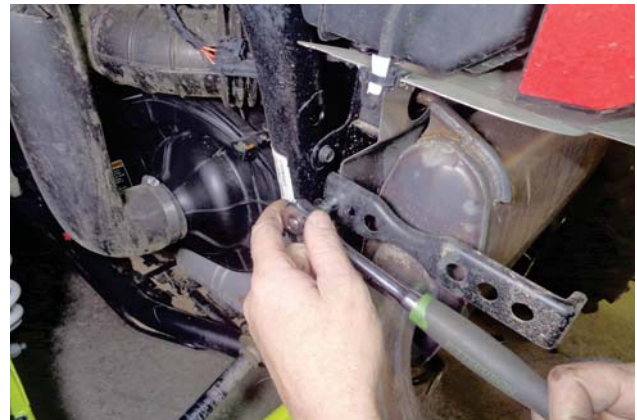

5. Remove the two upper heat shield brackets.



6. Remove the two lower heat shield brackets.

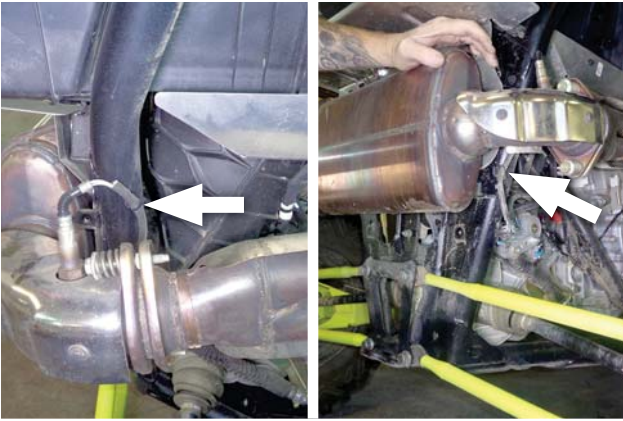

7. Carefully cut and remove the 2 cable ties securing the O2 sensor lead to the frame.



8. Disconnect the oxygen (O2) sensor lead from the electrical harness.



9. Remove the O2 sensor from the exhaust pipe.
NOTE: Use penetrating oil to avoid thread damage.



10. Apply anti-seize compound to the exposed threads of the 2 flange bolts to prevent seizing.



11. Remove the 2 flange bolts.



12. Use a spring puller to release the 2 muffler mount springs.



13. Remove the muffler from the vehicle.

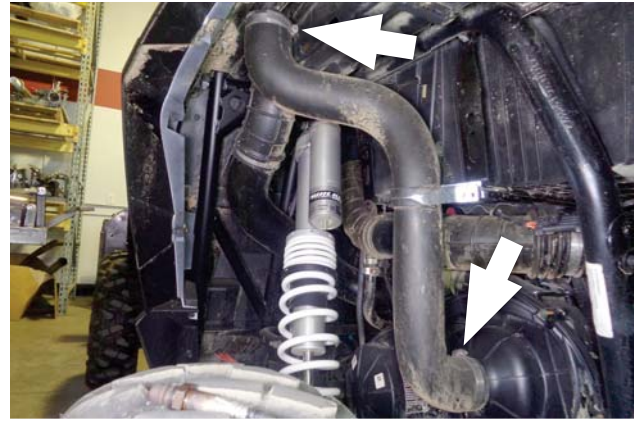

16. Loosen the screw clamps at each end of the duct.



14. Inspect the lead gasket on the end of the exhaust pipe for damage (cracks, etc.). Replace if required.



17. Assemble the bracket (item 11) to the clamp, using a screw (6) and flat washer (7) (on the outboard side), and a flat washer (7), lock washer (9) and nut (10) (on the inboard side).

MODIFY CLUTCH COOLING AIR DUCT CLAMP

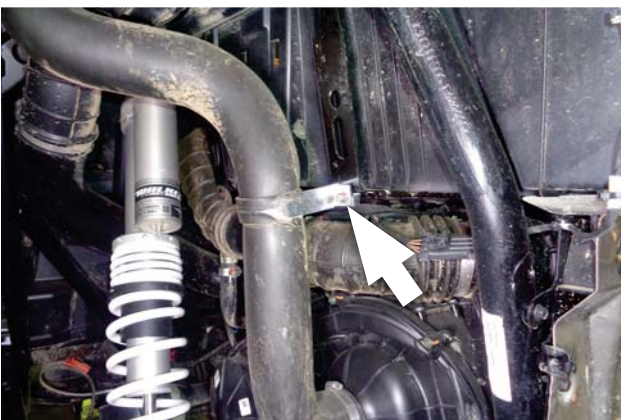

15. In the left rear wheel well, remove the bolt securing the clutch cooling air duct clamp to the frame.



18. Adjust the alignment of the duct as required, and secure the bracket to the vehicle using the stock clamp bolt.



19. Tighten the screw clamps at each end of the duct.

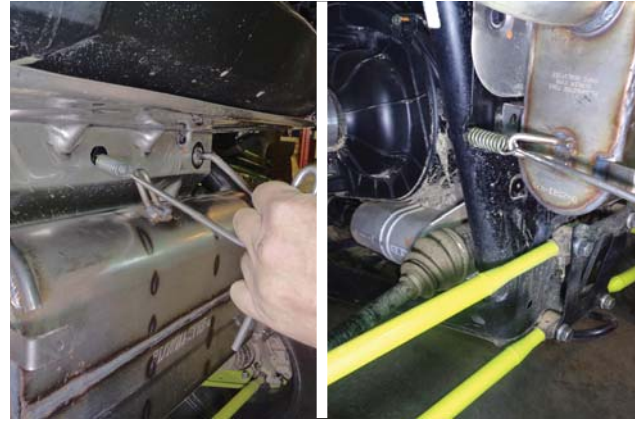

22. Use a spring puller to connect the 2 muffer mount springs to the muffer.

ASSEMBLE AND INSTALL YOUR XDR EXHAUST SYSTEM



20. Lubricate the 2 hanger pins on the muffer (1) with grease or oil.



23. Apply anti-seize compound to the two flange bolts, install them, and tighten them down evenly.

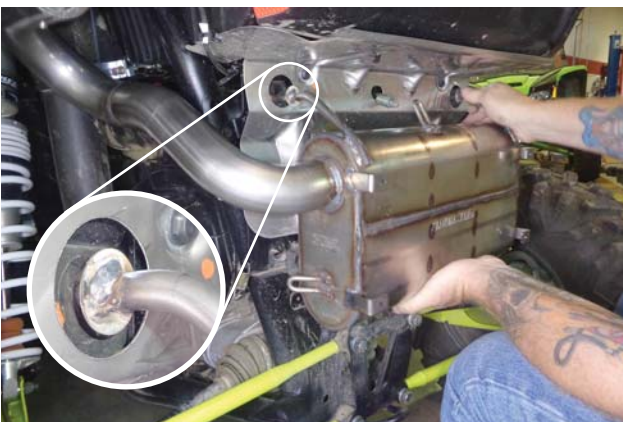

21. Install the muffer by pushing the hanger pins all the way into their rubber mounts. Verify proper alignment of the exhaust pipe and muffer flange.



24. Apply anti-seize compound to the O2 sensor threads. (Do not get compound on the tip of the sensor.) Then install the sensor in the exhaust pipe.

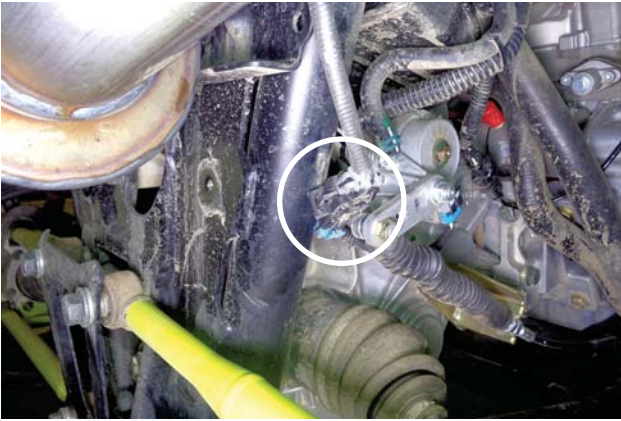

25. Connect the sensor lead to the electrical harness, and verify the connection is secure.

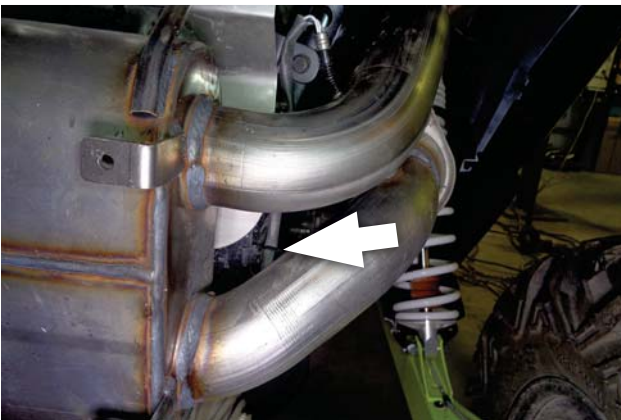

26. Secure the O2 sensor lead with the cable tie (12).



27. Place the heat shield backer (4) on a bench or other flat surface. Place spacers (8) over the top two holes.



28. Carefully lay the heat shield (5) over the spacers, and place flat washers (7) over the top two holes. Align the backer, shield and hardware holes, and insert screws (6) in them.



29. Grasp the aligned heat shield, backer and hardware, and hang the assembly on the muffler's two top mount holes. Then install a flat washer (7), lock washer (9), and nut (10) on each screw.
NOTE: Do not tighten the nut at this time.



30. At each bottom hole, hold a spacer (8) in between the heat shield and backer. Install a screw (6) with flat washer (7) through the stacked parts. Then install a flat washer (7), lock washer (9), and nut (10) on each screw.

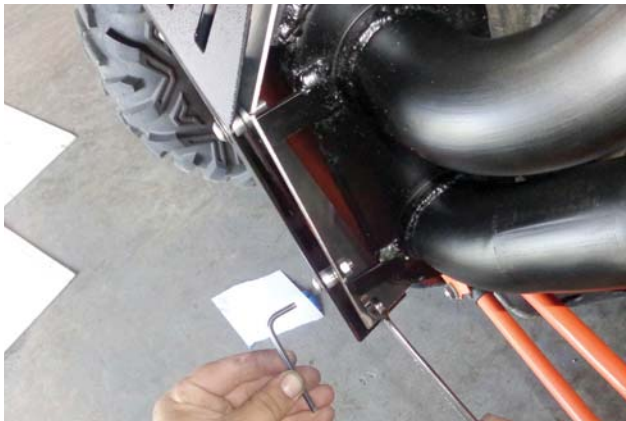

31. After the nuts have been started on all four mount screws, tighten the fasteners.

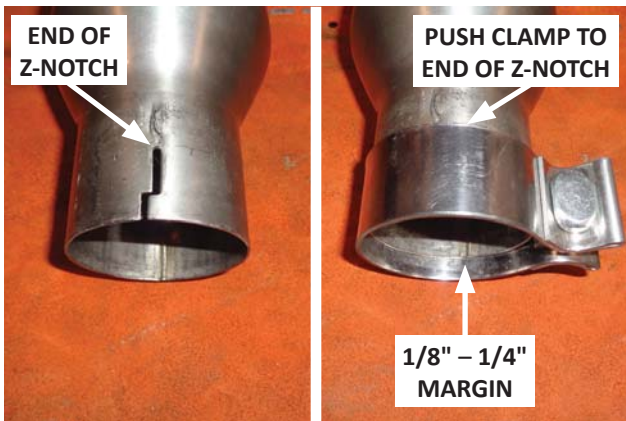

32. Install one clamp (2) on the opening of each exhaust tip (3). For best retention, push the clamp just to the end of the Z-notch, leaving 1/8" to 1/4" of the clamp extending past the tip opening.

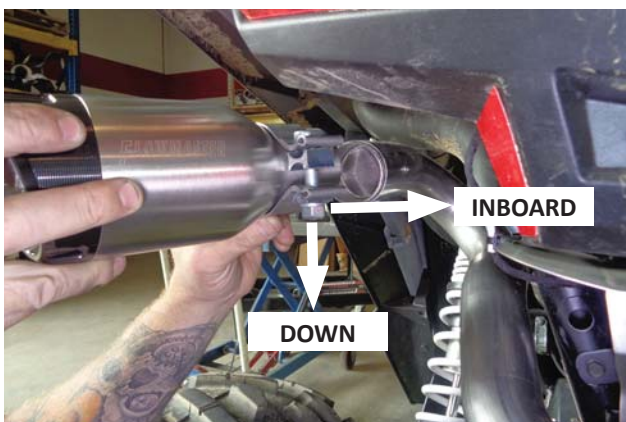

33. Note also that each clamp bolt should be on the inboard side of the tip, with its nut pointing down. Install each tip on its exhaust pipe.



34. Push each tip onto its pipe until its clamp touches the spark arrestor screws. Also be sure to keep the rear edge of the clamp just over the end of the Z-notch (per Step 32). When each tip is in place, tighten its clamp.



Congratulations, the installation of your XDR exhaust kit is now complete!

IMPORTANT: RETAIN THESE INSTRUCTIONS FOR FUTURE REFERENCE